

AT9000 Advanced Transmitter Electronic Differential Pressure/ Pressure Transmitter

User's Manual



Yamatake Corporation

NOTICE

While the information in this manual is presented in good faith and believed to be accurate, Yamatake Corporation disclaims any implied warranty of merchantability or fitness for a particular purpose and makes no express warranties except as may be stated in its written agreement with and for its customer.

In no event shall Yamatake Corporation be liable to anyone for any indirect, special or consequential damages. This information and specifications in this document are subject to change without notice.

Safety

Instructions

Preface

Correct installation and periodic maintenance are essential to the safe use of your differential pressure transmitters.

Read the safety instructions provided in this manual carefully and understand them fully before starting installation, operation, and maintenance work.

Inspection

On delivery, make sure that the specifications are correct and check for any damage that may have occurred during transportation. This equipment was tested under a strict quality control program before shipment. If you find any problem in the quality specifications, please contact your Yamatake Corporation representative immediately, providing the model name and serial number.

The name plate is mounted on the neck of the enclosure.

Precautions

The following symbols are used in this manual to ensure user safety.

WARNING

This symbol is used to warn of hazards where failure to observe a safety instruction may result in death or serious injury.

CAUTION

This symbol is used to warn of hazards where failure to observe a safety instruction may result in injury or physical damage.

To ensure safe operation, be sure to observe the safety instructions provided on the next page.

Yamatake Corporation will assume no responsibility, or offer any guarantee for any failure resulting from violation of these safety instructions.

Safety Manual

WARNING

Follow the instructions and procedures in this manual when the transmitter is used in SIS (Safety Instrumented Systems). Following description is applied when the AT9000 Advanced Transmitter model code Q1 of Option, "Safety Transmitter" is selected.

1. Application

Pressure measurements that shall meet the safety requirements according to IEC61508.

2. Safety related characteristics

2.1 Safety Integrity Level

The AT9000 can be used up to SIL2 application as in single use or SIL3 application as in dual use.

2.2 Start up

The safety output signal will be effective within 2 seconds after the start-up.

2.3 Safety Accuracy

The safety accuracy is +/-2% or +/-4% depending on models used.

2.4 Diagnostics time

The failures of the AT9000 can be detected within 5 minutes after they occur. The burnout signal can be output within 5 sec. after detecting the internal faults.

Item	Specification
Mode of operation	Low demand mode
SIL	SIL2 (in single use)
Device type	Type B
HFT	0 (in single use)

3. Safety functions

3.1 Safety- relevant signal

The safety relevant signal of the AT9000 is the analog output signal 4 to 20 mA. All safety functions refer to this analog output. The contact output or the digital output signal is not the safety relevant signal.

3.2 Normal Output

The analog current signal in the normal operating range of 3.6 to 21.6 mA including normal over range and under range is output.

3.3 Burnout output

The output will be driven to the Hi/Lo limit according to the setting.

In the following cases, the output will be driven to LO limit regardless of the burnout direction setting.

- Watchdog timer reset
- Internal voltage fault
- Readback error

After the detection of internal faults the AT9000 drives the signal to the fail alarm current of < 3.6 mA or > 21.6 mA.

In case of NE-43 option, after the detection of the internal faults the AT9000 drives the signal to the fail alarm current of $= 3.6$ mA or $= 21.0$ mA.

4. Non safety compliant activities

The transmitter output is not safety-compliant during the following activities

- Configuration modifications
- Multidrop
- Simulation
- Test of the safety function

During transmitter configuration and maintenance work on the AT9000, alternative measures must be taken to guarantee process safety.

5. Settings

6. Before start using

6.1 Safety- relevant signal

Before start using the AT9000 after installation, the following parameters shall be set.

Burnout direction

Write protect switch ^{note}

Note: The communicator shall not be used during the normal operation when the AT9000 is used in SIS as a safety transmitter.

7. Maintenance and repair

7.1 Maintenance and repair

Maintenance and repair shall be performed by a skilled and knowledgeable engineer.

7.2 Proof test

The procedure of the proof test is shown below. The test will cover 59% of possible DU failures.

- i) Bypass PLC or take other appropriate action to avoid a false trip.
- ii) Use the Communicator to retrieve any diagnostics and take appropriate action.
- iii) Use the Communicator to change the mode to B/O simulation mode.
- iv) Verify the output signal of B/O Hi.
- v) Verify the output signal of B/O Lo.
- vi) Return to normal operation
- vii) Remove the bypass from the PLC.

The following would be added to the above test. The tests including the following will cover 99% of possible DU failures.

- viii) Apply pressure to verify the output at 0%, 20%, 40%, 60%, 80% and 100%.

8. Terms and Abbreviation

SIS: Safety Instrumented Systems

SIL: Safety Integrity Level

HFT: Hardware Fault Tolerance

PFD: Probability of Failure on Demand

PLC: Programmable Logic Controller

B/O: Burnout (It means fail alarm status)

DU: Dangerous Undetected

Precautions

General Precautions

1. Checking the Product

When you accept the AT3000 Advanced Transmitter, check its appearance to make sure that it is not damaged.

An Advanced Transmitter with semi-standard or special specifications may have different accessories.

2. Check the specifications

The specifications are marked on the name plate on the outside of the transmitter case. Make sure that the specifications match your order by referring to the specifications.

In making an inquiry, identify the model No. and the product No.

3. Transportation

We recommend to transport the transmitter to the installation site in the packaged state in order to prevent damages from occurring during transportation.

4. Storage Environment

(1) Storage location

During storage, protect the transmitter from rain water as well as from heavy vibration and shock. Store it at normal temperature and humidity (about 25°C, 65%RH) as much as possible.

(2) Store the transmitter in original packaging if possible.

(3) If a used transmitter must be stored for some period, wash it thoroughly after making sure that no fluid remains in the pressure receiving section.

5. Installation Environment

In order to maintain the original performance and reliability for a long time, install the transmitter in the following environment:

(1) Ambient temperature

(a) The temperature gradient and temperature changes in installation environment should be as small as possible.

(b) If a transmitter is exposed to heat radiated from the process side, lower its ambient temperature as much as possible by insulating it or by selecting a well-ventilated location for installation.

(c) If a process fluid can freeze, prevent freezing by means of heat insulation.

(2) Environment

Pollution degree: 2

Avoid corrosive environment as much as possible.

Install in explosion proof and intrinsically safe conditions.

(3) Shock and vibration

Install the transmitter where shocks and vibrations will be as small as possible.

6. Application of Pressure to transmitter

In applying pressure to this transmitter, observe the following rules.

- (1) The locking bolts of the adapter flange are loose when shipped. Tighten them to the specified torque.
- (2) Do not apply a pressure that exceeds the specified level.
- (3) Do not tighten or loosen bolts while pressure is being applied to the transmitter.

7. Electronic Parts

- (1) This transmitter has several CMOS electronic components. Since static electricity can easily cause the functional destruction of a CMOS component, never directly touch them or touch a circuit with your hands.
- (2) If components must be touched, equalize the potential of the components before doing so.
- (3) When the printed wiring board (PWB) is removed, protect it in a non-conductive bag.

8. Contact us

Yamatake Corporation
Advanced Automation Company
A-12-2 Kawana, Fujisawa-shi
Kanagawa-ken, 25A-8522, Japan

Explosion protected Models

FM Explosionproof / Dust-ignition proof Approval

CAUTION

-
- Install the apparatus only in areas for which the apparatus has been approved.
 - Do not open the apparatus enclosure when an explosive atmosphere is present.
-

Marking information

Explosionproof for Class I, Division 1, Groups A, B, C and D; Class I, Zone 1, AEx d IIC

Dust-Ignitionproof for Class II, III, Division 1, Groups E, F and G

T5 $-40^{\circ}\text{C} \leq T_{\text{amb}} \leq +85^{\circ}\text{C}$

Hazardous locations

Indoor / Outdoor Type 4X, IP67

Factory sealed, conduit seal not required for Division applications

Caution - Use supply wires suitable for 5°C above surrounding ambient

Instruction for safe use

Installations shall comply with the relevant requirements of the National Electrical Code® (ANSI / FAPA 70).

FM Intrinsically safe, Nonincendive and Suitable Approvals

1 Rating information

1.1 Intrinsically safe

Intrinsically Safe for use in Class I, Division 1, Groups A, B, C and D; Class II, Division 1, Groups E, F and G; Class III, Division 1; Class I, Zone 0, AEx ia IIC; T4
 $-40\text{ °C} \leq T_{amb} \leq +60\text{ °C}$

Hazardous (Classified) Locations; Indoor/Outdoor Enclosure TYPE 4X, IP67;

For entity parameters see control drawings 80395278, 80395279 and 80395280.

1.2 Nonincendive and Suitable

Nonincendive, with Nonincendive Field Wiring Parameters, for use in Class I, Division 2, Groups A, B, C and D, T4; Class I, Zone 2, Group IIC, T4; Suitable for Class II & III, Division 2, Groups E, F and G, T4; $-40\text{ °C} \leq T_{amb} \leq +60\text{ °C}$; Hazardous (Classified) Locations;

Indoor/Outdoor Enclosure TYPE 4X, IP67;

For Nonincendive Field Wiring parameters see control drawing 80395494.

2 Applicable standards

- FM Class 3600:1998 Electrical Equipment for Use in Hazardous (Classified) Locations - General Requirements
- FM Class 3610:2007 Intrinsically Safe Apparatus and Associated Apparatus for Use in Class I, II & III, Division 1, Hazardous (Classified) Locations
- FM Class 3611:2004 Nonincendive Electrical Equipment for Use in Class I & II, Division 2, and Class III, Divisions 1 & 2, Hazardous (Classified) Locations
- FM Class 3810:2005 Electrical Equipment for Measurement, Control and Laboratory Use
- ANSI/ISA-12.00.01(IEC 60079-0 Mod):1999 Electrical Apparatus for Use in Class I, Zones 0, 1 & 2 Hazardous (Classified) Locations - Part 0: General Requirements
- ANSI/ISA-12.02.01(IEC 60079-11 Mod):2002 Electrical Apparatus for Use in Class I, Zones 0, 1 & 2 Hazardous (Classified) Locations - Part 11: Intrinsic Safety "i"
- ANSI/ISA-82.02.01(IEC 61010-1 Mod):2004 Safety Requirements for Electrical Equipment for Measurement, Control, and Laboratory Use - Part 1: General Requirements
- ANSI/IEC 60529:2004 Degrees of Protection Provided by Enclosures (IP Code)
- ANSI/NEMA 250:1991 Enclosures for Electrical Equipment (1,000 Volts Maximum)

3 Instruction for safe use

- 3.1 Installations shall comply with the relevant requirements of the National Electrical Code® (ANSI/NFPA 70).
- 3.2 Installations shall comply with the latest edition of the manufacturer's instruction manual.
IS models shall be installed in accordance with control drawings 80395278, 80395279 and 80395280, and NI models shall be installed in accordance with control drawing 80395494.
- 3.3 The intrinsically safe associated apparatus must be FM Approvals approved.
- 3.4 Control room equipment connected to the associated apparatus should not use or generate more than 250 Vrms or VDC.
- 3.5 See ANSI/ISA RP12.06.01, Installation of Intrinsically Safe Systems for Hazardous (Classified) Locations, for guidance on the installation of intrinsically safe apparatus and systems.
- 3.6 Tampering and replacement with non-factory components may adversely affect the safe use of the system.
- 3.7 Insertion or withdrawal of removable electrical connectors is to be accomplished only when the area is known to be free of flammable vapors.
- 3.8 For ambient temperatures below -10 °C (+14 °F) and above +60 °C (+140 °F) use field wiring suitable for both minimum and maximum ambient temperatures.
- 3.9 Use copper, copper-clad aluminum or aluminum conductors only.
- 3.10 The recommended tightening torque for field wiring terminals is 0.8 N·m (7 in·lb) or greater, as specified.
- 3.11 A dust-tight conduit seal shall be used when installed in Class II & III environments.
- 3.12 **WARNING - SUBSTITUTION OF COMPONENTS MAY IMPAIR INTRINSIC SAFETY**
- 3.13 **WARNING - SUBSTITUTION OF COMPONENTS MAY IMPAIR SUITABILITY FOR DIVISIONS 1 & 2 AND ZONES 0, 1 & 2**
- 3.14 **WARNING - DO NOT DISCONNECT EQUIPMENT UNLESS AREA IS KNOWN TO BE NONHAZARDOUS**
- 3.15 **WARNING - FOR CONNECTION ONLY TO NON-FLAMMABLE PROCESSES**

Manual No. CM2-GTX100-2001

ATEX Flameproof and Dust Certifications

1. Marking information

CE 0344  KEMA 08ATEX0004

II 1/2 G Ex d IIC T6 TPROCESS = 85 °C -30 °C ≤ Tamb ≤ +75 °C IP66 / 67
 II 1/2 G Ex d IIC T5 TPROCESS = 100 °C -30 °C ≤ Tamb ≤ +80 °C IP66 / 67
 II 1/2 G Ex d IIC T4 TPROCESS = 110 °C -30 °C ≤ Tamb ≤ +80 °C IP66 / 67
 II 2 D Ex tD A21 IP66 / 67 T85 TPROCESS = 85 °C -30 °C ≤ Tamb ≤ +75 °C
 II 2 D Ex tD A21 IP66 / 67 T100 TPROCESS = 100 °C -30 °C ≤ Tamb ≤ +75 °C
 II 2 D Ex tD A21 IP66 / 67 T110 TPROCESS = 110 °C -30 °C ≤ Tamb ≤ +75 °C

2. Applicable standards

- EN 60079-0: 2006 Electrical apparatus for explosive gas atmospheres - Part 0: General requirements
- EN 60079-1: 2007 Electrical apparatus for explosive gas atmospheres - Part 1: Flameproof enclosures "d"
- EN 60079-26: 2007 Explosive atmospheres - Part 26: Equipment with equipment protection level (EPL) Ga
- EN 6124A-0: 2006 Electrical apparatus for use in the presence of combustible dust - Part 0: General requirements
- EN 6124A-1: 2004 Electrical apparatus for use in the presence of combustible dust - Part 1: Protection by enclosures "tD"
- EN 60529:1992 Degree of protection provided by enclosures (IP code)

3. Instruction for safe use

- 3.1 To maintain the degree of protection of at least IP 66 in accordance with IEC 60529, suitable cable entries must be used and correctly installed. Unused openings must be closed with a suitable stopping plug.
- 3.2 Use supply wires suitable for 5 °C above surrounding ambient.
- 3.3 When Model No. is given with GTXxxx-x ... x-yx ... x-x ...,
 if y=A, the thread type of the end of all entries is 1/2NPT, or
 if y=B, the thread type of the end of all entries is M20.

4. Special conditions for safe use

- 4.1 The barrier diaphragm shall not be subjected environmental conditions which might adversely affect the partition wall.
- 4.2 Repairs of flameproof joints are allowed only by manufacturer.
- 4.3 The equipment must be returned to the manufacturer in case of failure.

ATEX Intrinsic safety, Type n and Dust Certifications

1. Marking information

1.1 Intrinsic safety and Dust

CE 0344  KEMA 07ATEX0200X

II 1 G Ex ia IIC T4 T_{PROCESS} = 105 °C -30 °C ≤ T_{amb} ≤ +60 °C IP66 / 67
ELECTRICAL PARAMETERS: U_i = 30 V, I_i = 93 mA, P_i = 1 W, C_i = 5 nF, L_i = 0.5 mH

II 1 D Ex iaD 20 IP66 / 67 T105 T_{PROCESS} = 105 °C -30 °C ≤ T_{amb} ≤ +60 °C

1.2 Type n and Dust

CE  KEMA 07ATEX0200X

II 3 G Ex nL IIC T4 T_{PROCESS} = 105 °C -30 °C ≤ T_{amb} ≤ +60 °C IP66 / 67
ELECTRICAL PARAMETERS: U_i = 30 V, C_i = 5 nF, L_i = 0.5 mH

II 2 D Ex tD A21 IP66 / 67 T85 T_{PROCESS} = 85 °C -30 °C ≤ T_{amb} ≤ +75 °C

II 2 D Ex tD A21 IP66 / 67 T100 T_{PROCESS} = 100 °C -30 °C ≤ T_{amb} ≤ +80 °C

II 2 D Ex tD A21 IP66 / 67 T110 T_{PROCESS} = 110 °C -30 °C ≤ T_{amb} ≤ +80 °C

2. Applicable standards

- EN 60079-0:2006 Electrical apparatus for explosive gas atmospheres - Part 0: General requirements
- EN 60079-11:2007 Explosive atmospheres - Part 11: Equipment protection by intrinsic safety "i"
- EN 60079-15:2005 Electrical apparatus for explosive gas atmospheres - Part 15: Construction, test and marking of type of protection "n" electrical apparatus
- EN 60079-26:2006 Explosive atmospheres - Part 26: Equipment with equipment protection level (EPL) Ga
- EN 6124A-0:2006 Electrical apparatus for use in the presence of combustible dust - Part 0: General requirements
- EN 6124A-1:2004 Electrical apparatus for use in the presence of combustible dust - Part 1: Protection by enclosures "tD"
- EN 6124A-11:2006 Electrical apparatus for use in the presence of combustible dust - Part 11: Protection by intrinsic safety "iD"

3. Instruction for safe use

- 3.1 To maintain the degree of protection of at least IP 66 in accordance with IEC 60529, suitable cable entries must be used and correctly installed. Unused openings must be closed with a suitable stopping plug.

3.2 Thread type of entry

When Model No.is given with GTXxxx-x ... x-yx ... x-x ...

If y=A, the thread type of entries is 1/2NPT, or

if y=B, the thread type of entries is M20.

4. Special conditions for safe use of intrinsic safety Ex ia (X certificate)

Because the enclosure of Model GTX is made of aluminium, if it is mounted in an area where the use of 1 G apparatus is required, it must be installed such, that, even in the event of rare incidents, ignition sources due to impact and friction sparks are excluded.

Manual No. CM2-GTX100-2001

IECEX Flameproof and Dust Certifications

1. Marking information

IECEX KEM 08.0001

Ga/Gb Ex d IIC T6 T_{PROCESS} = 85 °C -30 °C ≤ Tamb ≤ +75 °C IP66 / 67

Ga/Gb Ex d IIC T5 T_{PROCESS} = 100 °C -30 °C ≤ Tamb ≤ +80 °C IP66 / 67

Ga/Gb Ex d IIC T4 T_{PROCESS} = 110 °C -30 °C ≤ Tamb ≤ +80 °C IP66 / 67

Ex tD A21 IP66 / 67 T85 T_{PROCESS} = 85 °C -30 °C ≤ Tamb ≤ +75 °C

Ex tD A21 IP66 / 67 T100 T_{PROCESS} = 100 °C -30 °C ≤ Tamb ≤ +75 °C

Ex tD A21 IP66 / 67 T110 T_{PROCESS} = 110 °C -30 °C ≤ Tamb ≤ +75 °C

2. Applicable standards

- IEC 60079-0:2004 Electrical apparatus for explosive gas atmospheres - Part 0: General requirements
- IEC 60079-1:2007 Explosive atmospheres - Part 1: Equipment protection by flameproof enclosures "d"
- IEC 60079-26:2006 Explosive atmospheres - Part 26: Equipment with equipment protection level (EPL) Ga
- IEC 6124A-0:2004 Electrical apparatus for use in the presence of combustible dust - Part 0: General requirements
- IEC 6124A-1:2004 Electrical apparatus for use in the presence of combustible dust - Part 1: Protection by enclosures "tD"
- IEC 60529:2001 Degree of protection provided by enclosures (IP code)

3. Instruction for safe use

- 3.1 To maintain the degree of protection of at least IP 66 in accordance with IEC 60529, suitable cable entries must be used and correctly installed. Unused openings must be closed with a suitable stopping plug.
- 3.2 Use supply wires suitable for 5 °C above surrounding ambient.
- 3.3 When Model No. is given with GTXxxx-x ... x-yx ... x-x ...,
if y=A, the thread type of the end of all entries is 1/2NPT, or
if y=B, the thread type of the end of all entries is M20.

4. Special conditions for safe use

- 4.1 The barrier diaphragm shall not be subjected environmental conditions which might adversely affect the partition wall.
- 4.2 Repairs of flameproof joints are allowed only by manufacturer.
- 4.3 The equipment must be returned to the manufacturer in case of failure.

Manual No. CM2-GTX100-2001

IECEX Intrinsic safety, Type n and Dust Certifications

1. Marking information

1.1 Intrinsic safety and Dust

IECEX KEM 07.0058X

Zone 0 Ex ia IIC T4 T_{PROCESS} = 105 °C -30 °C ≤ Tamb ≤ +60 °C IP66 / 67

ELECTRICAL PARAMETERS: U_i = 30 V, I_i = 93 mA, P_i = 1 W, C_i = 5 nF, L_i = 0.5 mH

Ex iaD 20 IP66 / 67 T105 T_{PROCESS} = 105 °C -30 °C ≤ Tamb ≤ +60 °C

1.2 Type n and Dust

IECEX KEM 07.0058X

Ex nL IIC T4 T_{PROCESS} = 105 °C -30 °C ≤ Tamb ≤ +60 °C IP66 / 67

ELECTRICAL PARAMETERS: U_i = 30 V, C_i = 5 nF, L_i = 0.5 mH

Ex tD A21 IP66 / 67 T85 T_{PROCESS} = 85 °C -30 °C ≤ Tamb ≤ +75 °C

Ex tD A21 IP66 / 67 T100 T_{PROCESS} = 100 °C -30 °C ≤ Tamb ≤ +80 °C

Ex tD A21 IP66 / 67 T110 T_{PROCESS} = 110 °C -30 °C ≤ Tamb ≤ +80 °C

2. Applicable standards

- IEC 60079-0:2004 Electrical apparatus for explosive gas atmospheres - Part 0: General requirements
- IEC 60079-11:2006 Explosive atmospheres - Part 11: Equipment protection by intrinsic safety "i"
- IEC 60079-15:2005 Electrical apparatus for explosive gas atmospheres - Part 15: Construction, test and marking of type of protection "n" electrical apparatus
- IEC 60079-26:2006 Explosive atmospheres - Part 26: Equipment with equipment protection level (EPL) Ga
- IEC 6124A-0:2004 Electrical apparatus for use in the presence of combustible dust - Part 0: General requirements
- IEC 6124A-1:2004 Electrical apparatus for use in the presence of combustible dust - Part 1: Protection by enclosures "tD"
- IEC 6124A-11:2005 Electrical apparatus for use in the presence of combustible dust - Part 11: Protection by intrinsic safety "iD"

3. Instruction for safe use

3.1 To maintain the degree of protection of at least IP 66 in accordance with IEC 60529, suitable cable entries must be used and correctly installed. Unused openings must be closed with a suitable stopping plug.

3.2 Thread type of entry

When Model No. is given with GTXxxx-x ... x-yx ... x-x ...

If y=A, the thread type of entries is 1/2NPT, or if y=B, the thread type of entries is M20.

4. Special conditions for safe use of intrinsic safety Ex ia (X certificate)

Because the enclosure of Model GTX is made of aluminium, if it is mounted in an area where the use of 1 G apparatus is required, it must be installed such, that, even in the event of rare incidents, ignition sources due to impact and friction sparks are excluded.

Manual No. CM2-GTX100-2001

NEPSI Flameproof and Dust Certifications

AT9000 Advanced Transmitter type GTX Series, manufactured by Yamatake Corporation, has been approved by National Supervision and Inspection Center for Explosion Protection and Safety of Instrumentation (NEPSI) in accordance with the following standards:

- GB3836.1 - 2000 Electrical apparatus for explosive gas atmospheres
Part 1: General requirements
- GB3836.2 - 2000 Electrical apparatus for explosive gas atmospheres
Part 2: Flameproof enclosure "d"
- GB12476.1 - 2000 Electrical apparatus for use in the presence of combustible dust
Part A-1: Electrical apparatus protected by enclosures and surface temperature limitation - Specification for apparatus

Transmitters are approved with Ex marking of Ex d IIC T4~T6; DIP A21 T_A85°C / DIP A21 T_A100°C / DIP A21 T_A115°C. The certificate number is GYJ071268.

1. REQUIREMENTS FOR SAFE USE

- 1.1 The external earthing terminal shall be connected to the ground reliably at site.
- 1.2 The relationships between Ex marking, ambient temperature range and the maximum process temperature are shown below:

Ex marking	Ambient temperature range	Maximum process temperature
Ex d IIC T6DIP A21 T _A 85°C	-40°C ~ +75°C	80°C
Ex d IIC T5DIP A21 T _A 100°C	-40°C ~ +80°C	95°C
Ex d IIC T4DIP A21 T _A 115°C	-40°C ~ +80°C	110°C

- 1.3 The cable entry holes have to be connected by means of suitable cable entries with type of protection of Ex d IIC. The cable entries shall be approved by NEPSI in accordance with GB3836.A-2000, GB3836.2-2000 and GB12476.A-2000, which are covered by a separate examination certificate. The screws of the cable entries shall be 1/2-14NPT. Unwanted entry holes shall be blocked by blind plugs. After installation of the cable entry, the whole apparatus shall reach IP66/IP67.
- 1.4 The warning "Do not open while the circuit is alive" must be obeyed when the product is used in the explosive gas area.
- 1.5 Rated supply voltage: 10.8 ~ 42Vd.c. or 9 ~ 32Vd.c.
- 1.6 End users are forbidden to change the configuration to ensure the explosion protection performance of the product.
- 1.7 Regular cleanness shall be conducted to avoid the deposit of the dust.

- 1.8 When installation, operation and maintenance the product, users should comply with the relevant requirements of the product instruction manual and the following standards:

GB3836.13-1997 "Electrical apparatus for explosive gas atmospheres Part 13: Repair and overhaul for apparatus used in explosive gas atmospheres"

GB3836.15-2000 "Electrical apparatus for explosive gas atmospheres- Part 15: Electrical installations in hazardous area (other than mines)"

GB3836.16-2006 "Electrical apparatus for explosive gas atmospheres Part 16: Inspection and maintenance of electrical installation (other than mines)".

GB50257-1996 "Code for construction and acceptance of electric device for explosion atmospheres and fire hazard electrical equipment installation engineering"

GB12476.2-2006 "Electrical apparatus for use in the presence of combustible dust Part A-1: Electrical apparatus protected by enclosures and surface temperature limitation-Selection, installation and maintenance"

GB15577-1995 "Safety regulations for the protection of dust explosion".

NEPSI Intrinsic Safety Certification

AT9000 Advanced Transmitter type GTX Series, manufactured by Yamatake Corporation, has been approved by National Supervision and Inspection Center for Explosion Protection and Safety of Instrumentation (NEPSI) in accordance with the following standards:

- GB3836.1 - 2000 Electrical apparatus for explosive gas atmospheres
Part 1: General requirements
- GB3836.4 - 2000 Electrical apparatus for explosive gas atmospheres
Part 4: Intrinsic safety "i"
- GB3836.8 - 2000 Electrical apparatus for explosive gas atmospheres
Part 8: Type of protection "n"

Transmitters is approved with Ex marking of Ex ia IICT4; Ex nL IICT4. The certificate number is GYJ071269.

1.REQUIREMENTS FOR SAFE USE

1.1 The relationships between Ex marking, ambient temperature range and maximum process temperature are shown in the table below:

Ex marking	Ambient temperature range	Maximum process temperature
Ex ia IICT4	-40°C ~ +60°C	105°C
Ex nL IICT4	-40°C ~ +60°C	110°C

1.2 Only be connected to a certified associated apparatus or a certified associated energy-limited apparatus, the product could be used in the explosive atmosphere. The connection shall be accordance with the requirements of the manual of the associated apparatus and the product.

1.2.1 Intrinsically safe parameters:

Max. input Voltage Ui (V)	Max. input current Ii (mA)	Max. input power Pi (W)	Max. internal parameter	
			Ci (nF)	Li (mH)
30	100	1	13	0.5

1.2.2 The cable with shield is suitable for connection, the cross-sectional area of the wire shall be at least 0.5 mm², and the shield shall be connected to the earth in the non-hazardous area.

1.3 End users are forbidden to change the configuration to ensure the explosion protection performance of the product.

- 1.4 When installation, operation and maintenance the product, users should comply with the relevant requirements of the product instruction manual and the following standards:

GB50257-1996 "Code for construction and acceptance of electric device for explosion atmospheres and fire hazard electrical equipment installation engineering".

GB3836.13-1997 "Electrical apparatus for explosive gas atmospheres Part 13:Repair and overhaul for apparatus used in explosive gas atmospheres".

GB3836.15-2000 "Electrical apparatus for explosive gas atmospheres- Part 15: Electrical installations in hazardous area (other than mines)"

GB3836.16-2006 "Electrical apparatus for explosive gas atmospheres- Part 16: Inspection and maintenance of electrical installation (other than mines)".

MEMO

Safety

Chapter 1 : Overview-First Time Users Only

1.1 : Introduction	1-1
1.2 : AT9000 Advanced Transmitters	1-1
1.3 : Parts names of the transmitter	1-2
1.4 : Transmitter Order	1-4

Chapter 2 : Installation

2.1 : Introduction	2-1
2.2 : Mounting AT9000 Advanced Transmitter	2-1
2.3 : Piping AT9000 Advanced Transmitter	2-8
2.3.1 : Piping for Liquid, Gas or Steam Flow Rate Measurement	2-11
2.3.2 : Pressure Measurement - Piping	2-14
2.3.3 : Liquid Level Measurement - Piping (GTX__D/GTX__G).....	2-16
2.4 : Wiring AT9000 Advanced Transmitter	2-21
2.4.1 : Wiring for Transmitter -- Regular Model	2-21

Chapter 3 : Operation of the Transmitter

3.1 : Preparation	3-1
3.1.1 : Connecting communicator	3-1
3.1.2 : HART® 375 FIELD COMMUNICATOR keyboard	3-2
3.1.3 : Symbols on communicator screen	3-2
3.1.4 : Keying in alphanumeric characters	3-2
3.2 : Setting and Checking Specifications	3-3
3.2.1 : Establishing Communications	3-3
3.2.2 : Setting Tag No.....	3-4
3.2.3 : Checking Output Format	3-4
3.2.4 : Checking Display Setting.....	3-4
3.2.5 : Display Mode	3-5
3.2.6 : Display Function	3-5
3.2.7 : Checking Engineering Unit of Measured Pressure.....	3-5
3.2.8 : Checking Low and High Limits of Setting Range	3-5
3.2.9 : Adjusting Damping Time Constant	3-6
3.2.10 : Checking Fill fluid temperature compensation.....	3-6
3.3 : Measurement with model GTX__D.....	3-7
3.3.1 : Flow Rate Measurement	3-7
3.3.2 : Gas Pressure Measurement.....	3-11
3.3.3 : Liquid Level Measurement of Open Tank and Closed Tank (Dry Leg).....	3-15
3.3.4 : Liquid Level Measurement of Closed Tank (Wet Leg)	3-19
3.4 : Measurement with Model GTX__D/GTX__A.....	3-23

Table of Contents

3.4.1 : Pressure Measurement.....	3-23
3.5 : Measurement with Model GTX__F	3-27
3.5.1 : Pressure Measurement.....	3-27
3.6 : Measurement with Model GTX__U/GTX__R.....	3-29
3.6.1 : Pressure Measurement.....	3-29
3.6.2 : Cautions Related to Flow Rate Measurement	3-30
3.7 : Measurement with Model GTX__U	3-31
3.7.1 : Pressure Measurement.....	3-31
3.8 : Set Range Calculation for Liquid Level Measurement.....	3-33
3.8.1 : Open Tank or Closed Tank (Dry Leg) or Remote Seal Set Range Calculation	3-33
3.8.2 : Closed Tank (Wet Leg or Remote Seal) -- Set Range.....	3-38
3.9 : Indicator (Optional).....	3-41
3.9.1 : Display unit of indicator	3-41
3.9.2 : Bar Graph Display.....	3-42
3.9.3 : External Zero/Span Adjustment Display	3-42
3.9.4 : Square Root Extraction Display	3-43
3.9.5 : Write Protect Display	3-43
3.9.6 : Status Record Display	3-43
3.9.7 : Display Update Mark.....	3-43
3.10 : External Zero/Span Adjustment function (Optional).....	3-44

Chapter 4 : Operation Using HART® Communicator

4.1 : Starting Communications	4-1
4.1.1 : Connecting communicator	4-1
4.1.2 : HART® 375 FIELD COMMUNICATOR keyboard	4-2
4.1.3 : Symbols on communicator screen.....	4-2
4.1.4 : Keying in alphanumeric characters.....	4-2
4.1.5 : Establishing communications.....	4-3
4.1.6 : Checking basic data.....	4-3
4.2 : Configuration.....	4-5
4.3 : Top menu	4-5
4.4 : Process Variables menu summary	4-6
4.5 : Device menu summary	4-7
4.6 : Diagnostic menu summary	4-11
4.6.1 : Changing tag no.....	4-12
4.6.2 : Changing output format	4-12
4.6.3 : Indicator display format.....	4-12
4.6.4 : Change Cutoff Mode.....	4-13
4.6.5 : Selecting unit of measurement	4-14
4.6.6 : Setting range values	4-14
4.6.7 : Adjusting damping time.....	4-14
4.7 : Start-up and Operation.....	4-15

Table of Contents

4.7.1 : Running analog output check	4-15
4.7.2 : Configuring ranges with applying pressure	4-15
4.7.3 : Alarm Settings	4-16
4.7.4 : Write Protect.....	4-19
4.8 : Calibration.....	4-20
4.8.1 : Calibrating analog output signal	4-20
4.8.2 : Calibrating range	4-21
4.8.3 : Resetting calibration	4-21

Chapter 5 : Maintenance

5.1 : Disassembly and Assembly	5-2
5.1.1 : Before You Start	5-2
5.1.2 : Mount Center Body Cover and Adapter Flange	5-3
5.1.3 : Washing the Center Body.....	5-5
5.2 : Calibrating Set Range and Output Signals	5-6
5.2.1 : Calibrating Set Range Based on Reference Input.....	5-6
5.2.2 : Calibrating Output Signals.....	5-9

Chapter 6: Troubleshooting

Appendix A - Supplement Manual for CommPad

Section 1 : Introduction	A-1
Section 2 : How to Connect Your CommPad to the Advanced Transmitter	A-2
Section 3 : Menu Structure	A-3
Section 4 : How to Operate CommPad.....	A-5
4.1: How to Start CommPad	A-5
4.2: Home Screen.....	A-5
4.3: User Selection Screen	A-6
4.4: Summary Screen	A-8
4.5: Status Screen	A-8
4.6: Help Screen	A-9
4.7: Configuration Screen	A-10
4.8: Setup Screen	A-11
4.9: Maintenance Screen.....	A-12
4.10: All Functions Screen.....	A-13
4.11: NVM Save	A-15
4.12: Tag	A-17
4.13: Range	A-22
4.14: Remote-seal	A-27
4.14.1: Auto Range (Closed Tank).....	A-28
4.14.2: Set LRV (Actual)	A-36
4.14.3: Amb. Temp. Compensate	A-38

Table of Contents

4.15: Display	A-46
4.16: Damping	A-50
4.17: Conformity	A-51
4.18: Checking the Fail-safe Direction.....	A-56
4.19: Output Limit	A-59
4.20: Memo.....	A-62
4.21: Monitoring.....	A-64
4.22: Adjustment.....	A-65
4.22.1: Set LRV (0%)	A-65
4.22.2: URV adjustment.....	A-68
4.22.3: Set LRV (Actual)	A-70
4.23: Calibration	A-73
4.23.1: Correct zero input.....	A-73
4.23.2: Correct LRV	A-76
4.23.3: Correct URV.....	A-78
4.23.4: Restore factory settings	A-80
4.23.5: Reset corrections	A-81
4.24: Output Mode.....	A-84
4.25: 4-20 mA Correct	A-89
4.26: PROM No.	A-91
4.27: Software Version	A-91
4.28: Sensor Temp.	A-92
4.29: DE/Analog Select (Switching between digital and analog communications output).....	A-93
4.30: DE Configuring	A-95
4.31: Records	A-96
4.31.1: Zero Calibr. Log in CommPad.....	A-96
4.31.2: Zero Calibr. Log in Device.....	A-100
4.31.3: Status Records.....	A-103
4.32: Alarm/Contact Output	A-107
4.33: Data Overwrite Protection	A-114
4.34: Settings screen.....	A-115
Section 5 : Saving Data	A-119
Section 6 : Troubleshooting	A-124

Appendix B - Damping time constant related calibration span when shipped

Appendix C - General Specifications

List of Figure

Figure 1-1	AT9000 Advanced Transmitter Family	1-1
Figure 1-2	Structure of the transmitter (model GTX __D).....	1-2
Figure 1-3	Typical AT9000 Advanced Transmitter Order Components	1-4
Figure 2-1	Typical Bracket Mounted and Flange Mounted Installations.	2-1
Figure 2-2	2-2
Figure 2-3	2-2
Figure 2-4	2-3
Figure 2-5	Typical Flange Mounted Transmitter Installation.....	2-3
Figure 2-6	Typical Remote Diaphragm Seal Transmitter Installation.....	2-5
Figure 2-7	2-5
Figure 2-8	Typical 3-Valve Manifold and Blow-Down Piping Arrangement.....	2-8
Figure 2-9	Piping for Liquid Flow Rate Measurement - Example	2-11
Figure 2-10	Piping for Gas Flow Rate Measurement - Example	2-12
Figure 2-11	Piping for Steam Flow Rate Measurement - Example	2-13
Figure 2-12	Gas Pressure Measurement - Piping.....	2-14
Figure 2-13	Example of Piping.....	2-15
Figure 2-14	H mark on center body	2-16
Figure 2-15	Open Tank - Piping Example	2-17
Figure 2-16	Closed Tank - Piping (Dry-leg Sealing Example).....	2-18
Figure 2-17	Closed Tank - Piping (Wet-leg Sealing Example)	2-19
Figure 2-18	Wiring for transmitter without Alarm output	2-21
Figure 2-19	Wiring for transmitter with Alarm output	2-22
Figure 2-20	External Grounding or Bonding Connection.....	2-23
Figure 2-21	Supply Voltage and External Load Resistance - Relationship.....	2-24
Figure 2-22	AT9000 Advanced Transmitter Terminal Block.....	2-24
Figure 3-1	3-1
Figure 3-2	HART® 375 FIELD COMMUNICATOR	3-2
Figure 3-3	3-27
Figure 3-4	3-29
Figure 3-5	3-31
Figure 3-6	Open Tank	3-33
Figure 3-7	Closed Tank.....	3-33
Figure 3-8	3-34
Figure 3-9	Open Tank	3-35
Figure 3-10	Closed Tank.....	3-35
Figure 3-11	Open Tank	3-36
Figure 3-12	Open Tank	3-37
Figure 3-13	Closed Tank (Wet Leg)	3-38
Figure 3-14	Closed Tank (Wet Leg)	3-39
Figure 3-15	Closed Tank (Wet Leg)	3-40
Figure 3-16	Display unit of indicator.....	3-41
Figure 3-17	3-44
Figure 4-1	4-1
Figure 4-2	HART® 375 FIELD COMMUNICATOR	4-2
Figure 4-3	4-17
Figure 4-4	4-18
Figure 4-5	4-19
Figure 5-1	Locking Case Cover	5-2
Figure 5-2	Center Body Cover Fixing Bolts	5-3
Figure 5-3	Connection for calibration.....	5-7
Figure 5-4	Connection for Calibration.....	5-9
Figure A-1	Wiring for connection with Model GTX.....	A-2
Figure A-2	Supply voltage vs. load resistance.....	A-2

List of Table

Table 2-1	Mounting Remote Diaphragm Seal Transmitter	2-4
Table 2-2	2-6
Table 2-3	Process Connections.....	2-9
Table 2-4	Installing Adapter Flange	2-10
Table 5-1	Cover Bolts / Nuts and Tightening Torque	5-4
Table 5-2	Adapter Flange Bolt / Nut Tightening Torque	5-4

Chapter 1 : Overview-First Time Users Only

1.1 : Introduction

This section is intended for users who have never worked with our AT9000 Advanced Transmitter. It provides some general information to acquaint you with the AT9000 Advanced Transmitter.

1.2 : AT9000 Advanced Transmitters

Yamatake's AT9000 Advanced Transmitter includes model variations of these basic pressure measurement types.

- Differential Pressure
- Gauge Pressure
- Absolute Pressure

Transmitter adjustments

Except for optional zero and span adjustments available with AT9000 Advanced Transmitters only, the AT9000 Advanced Transmitter has no physical adjustments.

You need a CommPad or HART® 375 communicator to make adjustments to a AT9000 Advanced Transmitter

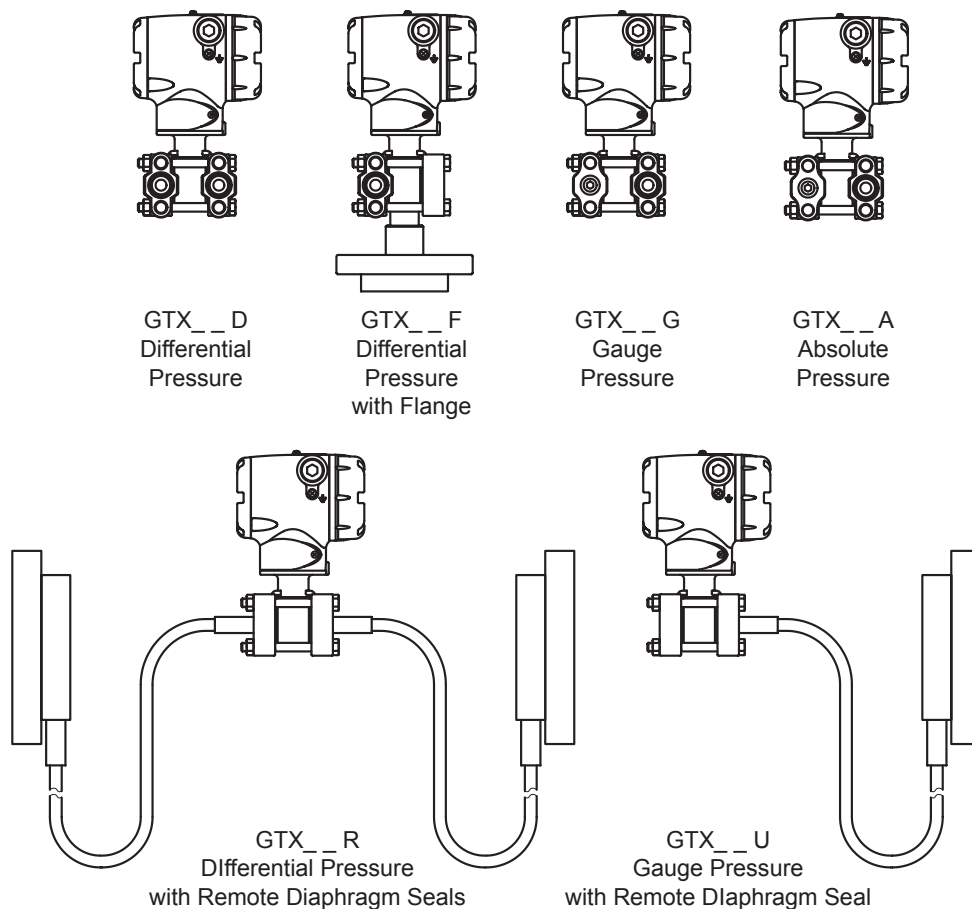

Figure 1-1 AT9000 Advanced Transmitter Family

1.3 : Parts names of the transmitter

Introduction

This transmitter consists mainly of a terminal board, an electronics module, a transmitter unit case, an indicator, and a center body.

Structure and parts names

The following illustration shows the structure and parts names of this transmitter:

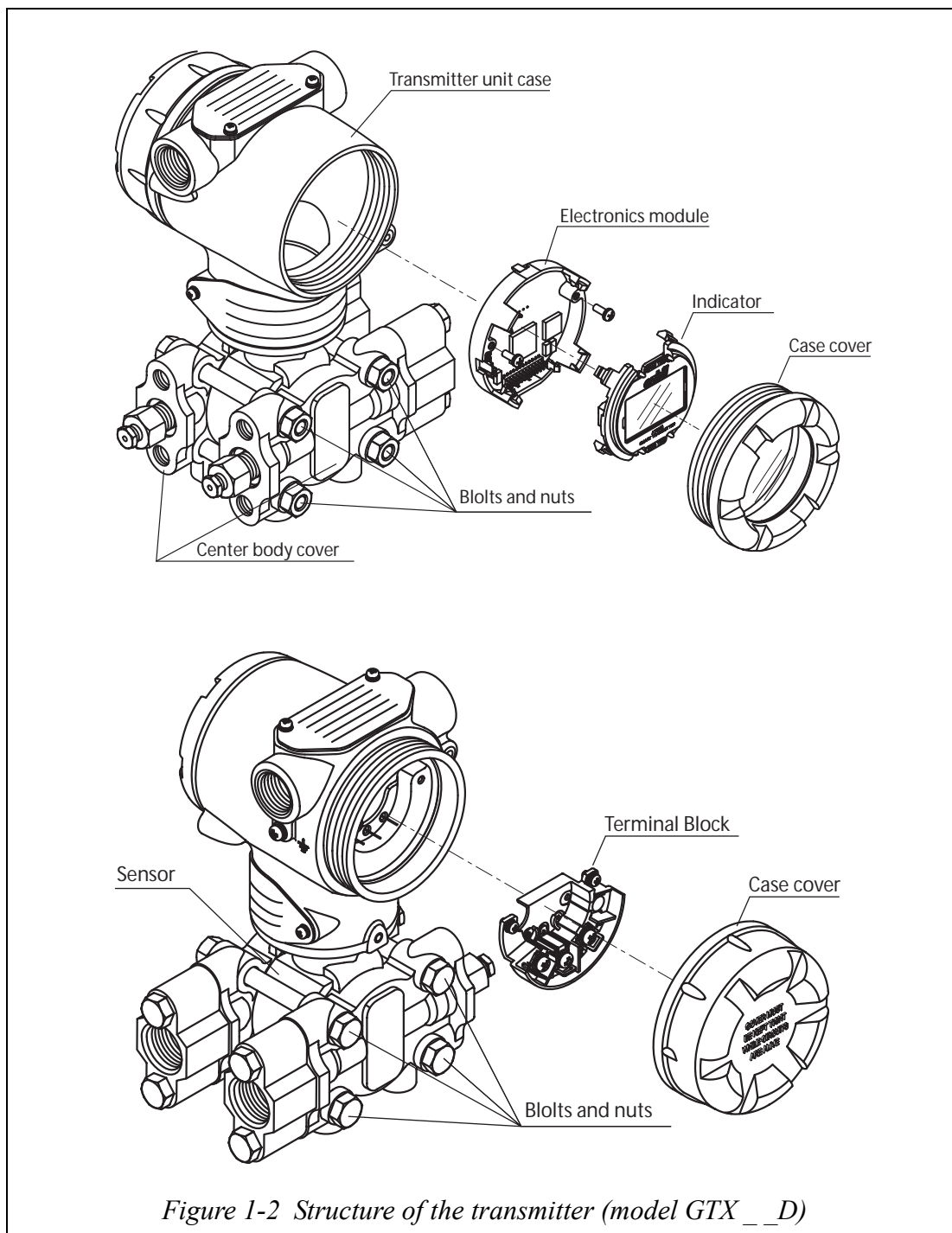

Parts name	Description
Center body	Consists of a composite semiconductor sensor, a pressure diaphragm, an excessive pressure protection mechanism, etc.
Center body cover	Two center body covers sandwich the center body. Process connection is made to this part.
Bolts and nuts	Fixing the center body between covers, are a series of bolts and nuts.
Sensor	Consists of a composite semiconductor sensor, a pressure receiving diaphragm, a flange, a capillary tube, etc.
Electronics module	Consists of electronic circuits having functions for processing differential pressure and other signals, and transmitting them.
Transmitter unit case	Housing the electronics module and the terminal board.
Case cover	Encloses the transmitter unit case.
Indicator	It display output value, unit, error message, etc.

1.4 : Transmitter Order

Order components

Figure 1-3 shown the components that are shipped and should be received for a typical AT9000 Advanced Transmitter order.

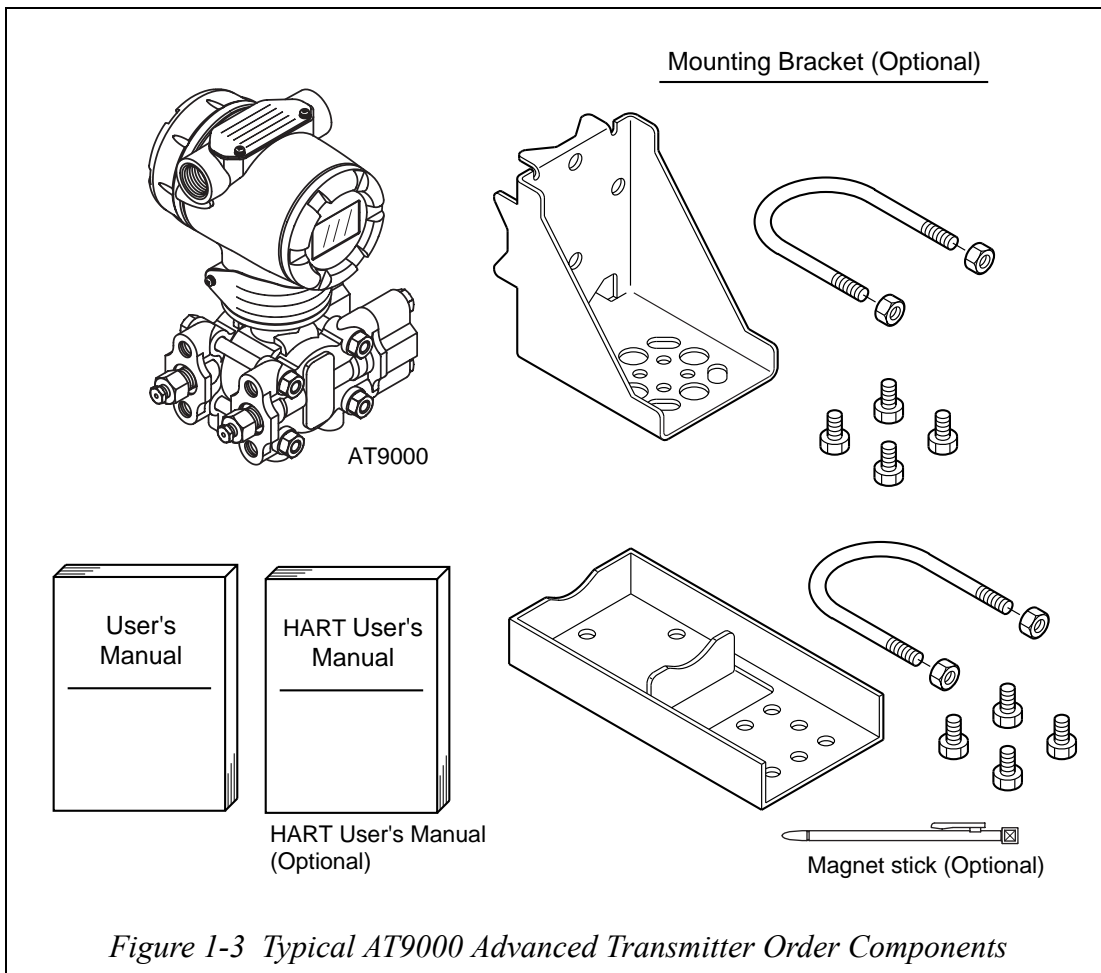

Figure 1-3 Typical AT9000 Advanced Transmitter Order Components

Chapter 2 : Installation

2.1 : Introduction

This section Provides information about installing the AT9000 Advanced Transmitter. It includes procedures for mounting, piping and wiring the transmitter for operation.

2.2 : Mounting AT9000 Advanced Transmitter

Summary

You can mount all transmitter models except those with integral flanges to a 2-inch (50 mm) vertical or horizontal pipe using our optional angle or flat mounting bracket or a bracket of your own. Those models with integral flanges are supported by the flange connection.

Figure 2-1 shows typical bracket mounted and flange mounted transmitter installations for comparison.

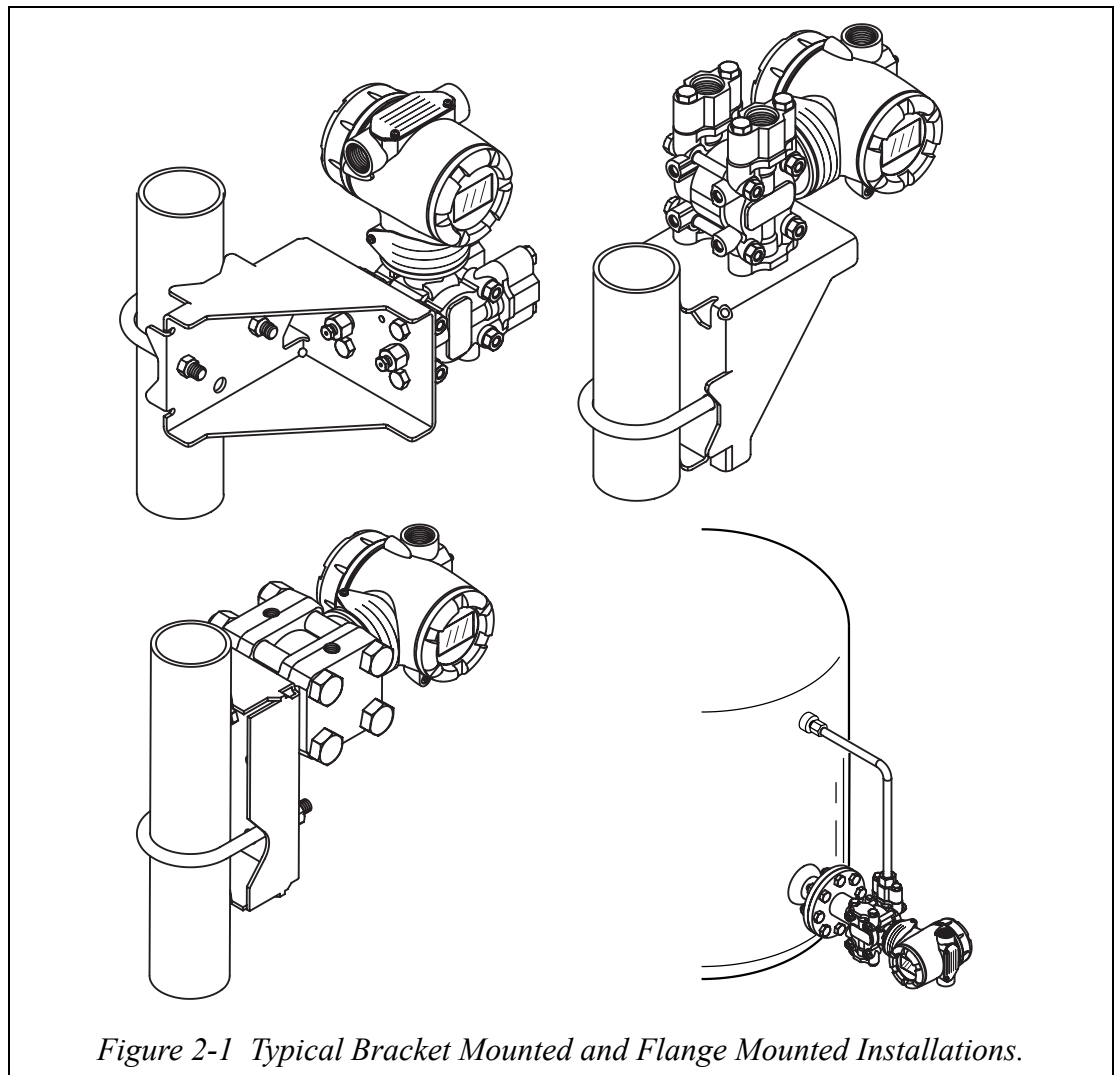

Methods of changing direction of indicator after mounted are shown below.

a) Rotate electronics housing 90° horizontally.

Loosen 3 mm set screw on outside neck of transmitter. Rotate electronics housing in a maximum of 90 degree increments (left or right) from the center to a position you require and tighten the set screw.

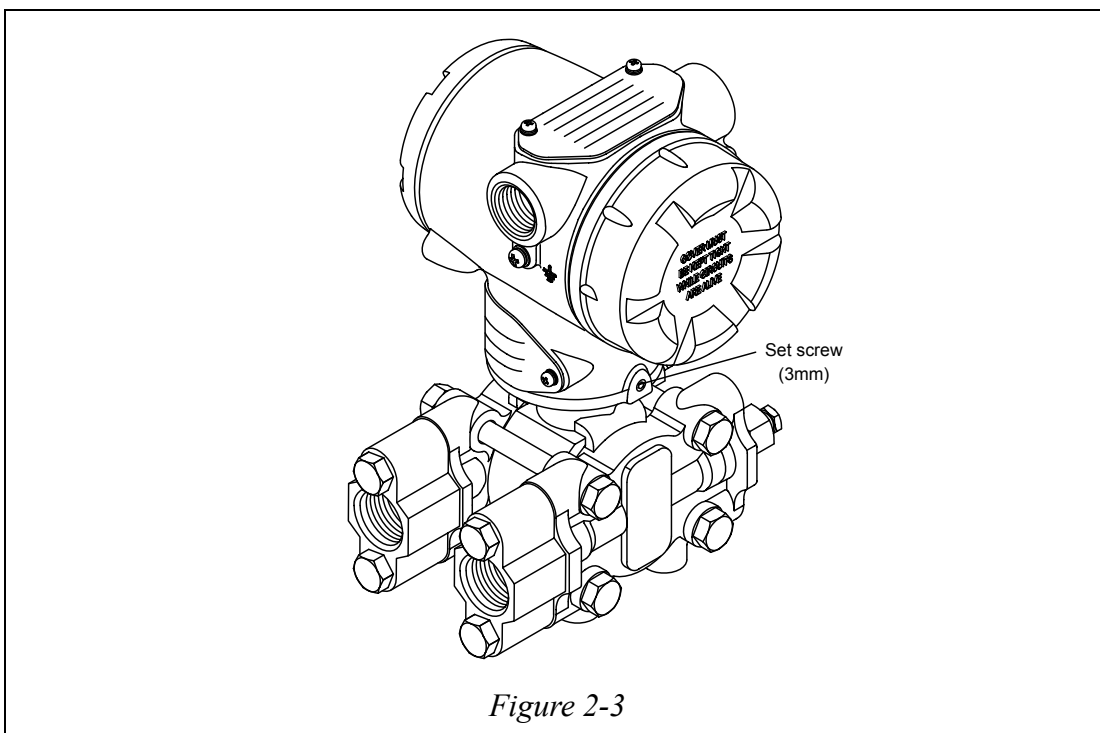
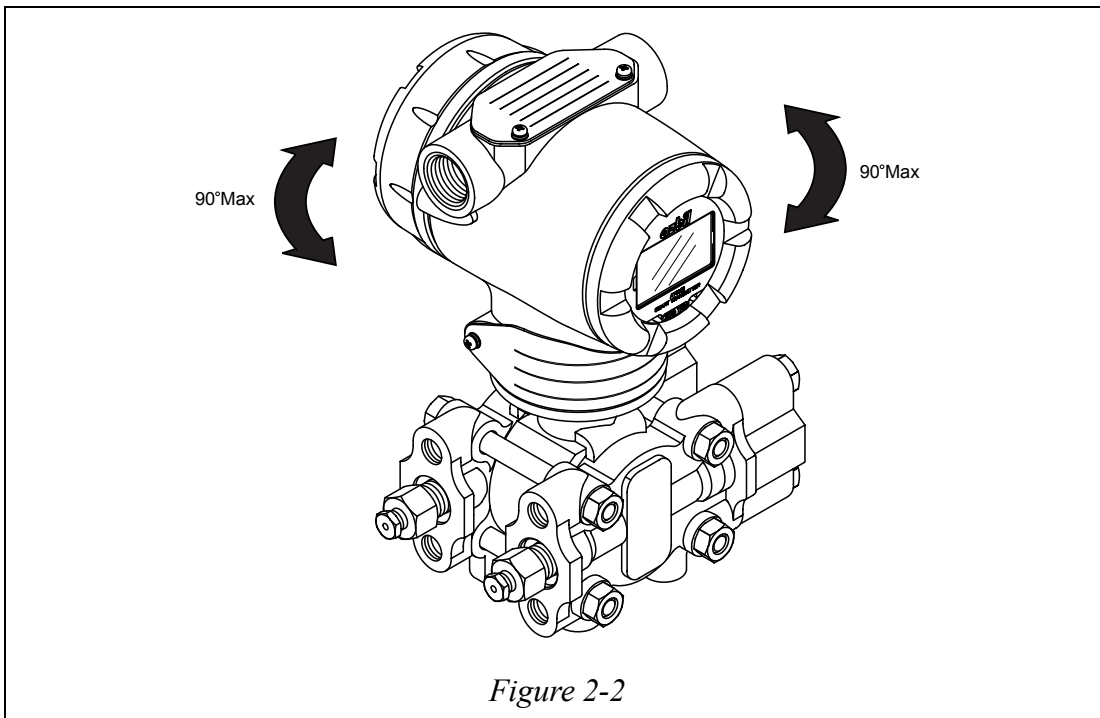

b) Rotate digital display module

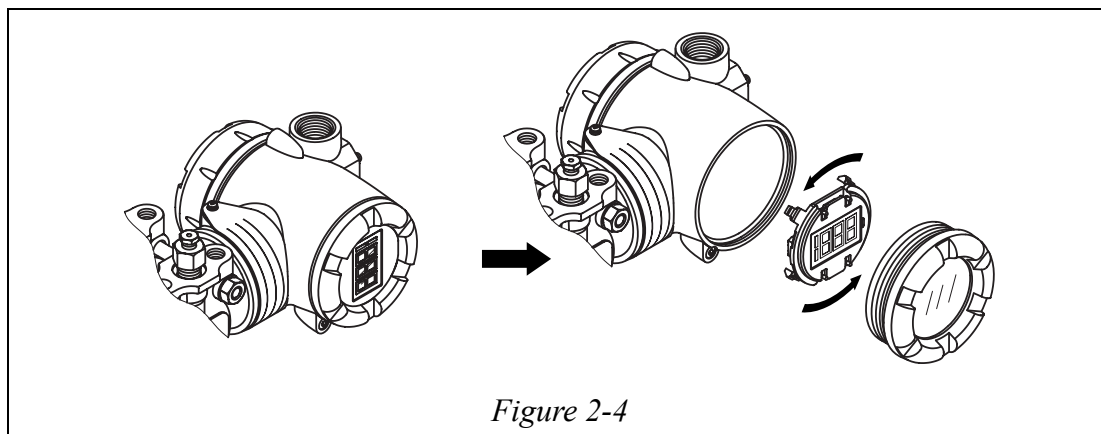

Figure 2-4

Flange mounting

To mount a flange mounted transmitter model, bolt the transmitter’s flange to the flange pipe on the wall of the tank. Tighten the bolts to a torque of

SNB : $20 \pm 1 \text{ N} \cdot \text{m}$

SUS304 : $10 \pm 1 \text{ N} \cdot \text{m}$

ATTENTION

On insulated tanks, remove enough insulation to accommodate the flange extension.

Figure 2-5 shows a typical installation for a transmitter with the flange on the high pressure (HP) side so the HP diaphragm is in direct contact with the process fluid. The low pressure (LP) side of the transmitter is vented to atmosphere (no connection).

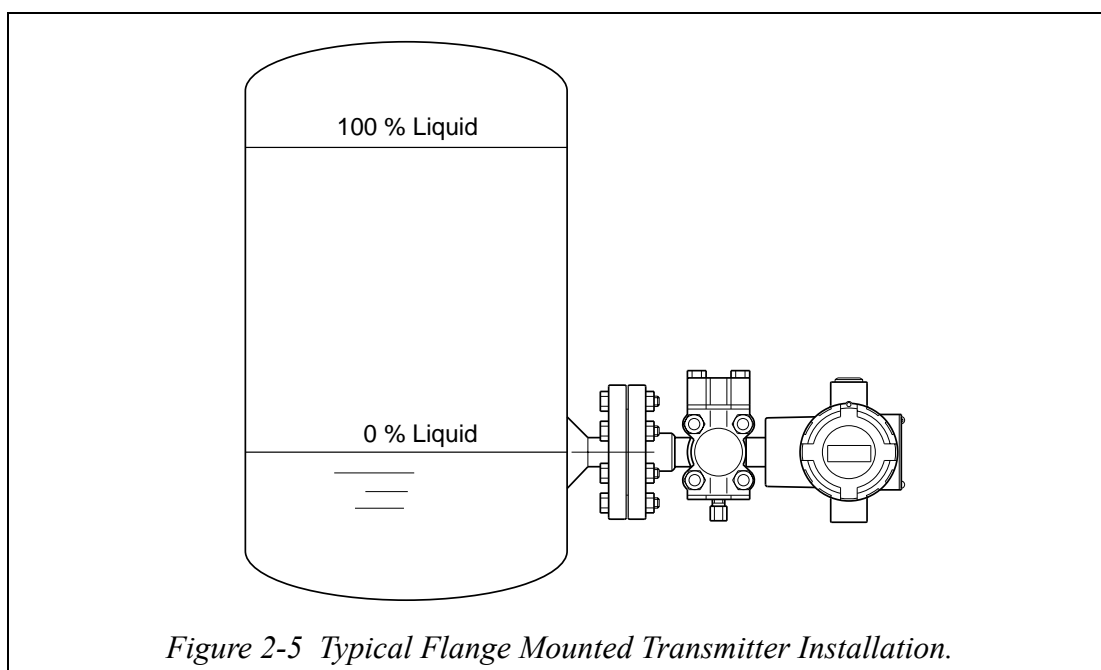

Figure 2-5 Typical Flange Mounted Transmitter Installation.

Remote seal mounting

Use the procedure in "Table 2-1 Mounting Remote Diaphragm Seal Transmitter" to mount a remote diaphragm seal transmitter model. Figure 2-6 shows a typical installation for a remote diaphragm seal transmitter for reference.

ATTENTION

Mount the transmitter flanges within the limits stated here for the given fill-fluid in the capillary tubes with a tank at one atmosphere.

Table 2-1 Mounting Remote Diaphragm Seal Transmitter

Step	Action
1	Mount transmitter at a remote distance determined by length of capillary tubing.
2	<p>If Transmitter Model Number Is... GTX35R GTX40R</p> <p>Then Connect Remote Seal on... H mark side of transmitter to upper flange mounting on tank wall.</p> <p><u>ATTENTION</u> On insulated tanks, remove enough insulation to accommodate the flange extension.</p>
3	<p>If Transmitter Model Number is... GTX35R GTX40R</p> <p>Then Connect Remote Seal on... Opposite side of transmitter to lower flange mounting on tank wall.</p> <p><u>ATTENTION</u> On insulated tanks, remove enough insulation to accommodate the flange extension.</p>
4	Tighten bolts to torque of SNB7: $20 \pm 1 N \cdot m$, SUS304: $10 \pm 1 N \cdot m$.

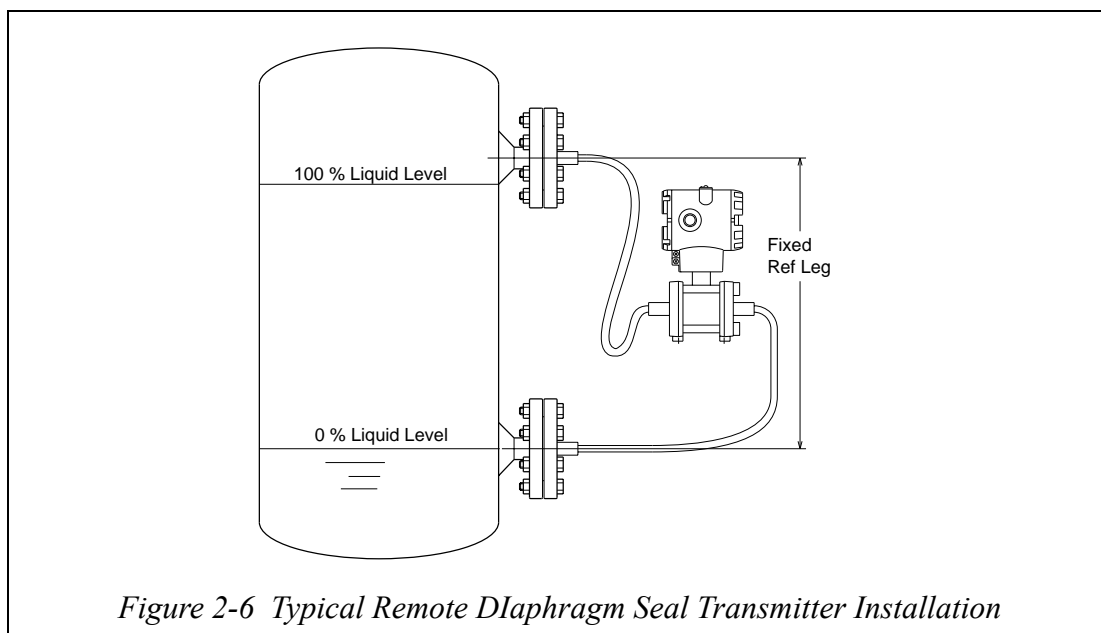

ATTENTION

Calculation of Allowable Transmitter Installation Location in Remote Seal Type Differential Pressure Transmitter.

When installing a remote seal type differential pressure transmitter on an enclosed tank, we recommend the installation of the main unit below the lower flange. However, it is sometimes necessary to install the transmitter main unit between the upper and lower flanges due to piping restrictions.

The condition that must be satisfied to ensure normal transmitter operations is specified here.

If a transmitter is installed in the position shown in Figure 2-7, the inner pressure of the tank (P_0) and the head pressure of the liquid sealed in the capillary can be applied to its main unit (low limit flange side).

The transmitter functions normally as long as the pressure applied to its diaphragm surface is equal to or higher than the low limit P (kPa abs.) of the allowable pressure of its main unit.

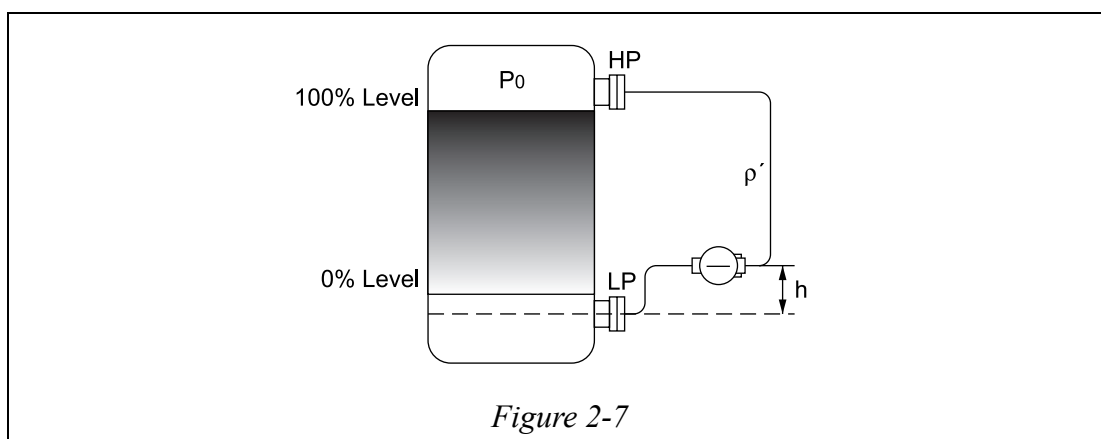

This condition can be expressed with the following formula;

$$P_0 + ((\rho'h)/102) \geq P(1kPa= 102mmH_2O)$$

Therefore, $h \leq (P_0 - P) \times 102 / (\rho')$

Table 2-2

	Specific gravity of sealed liquid ρ'	Low limit of allowable pressure P (kPa abs.)	Liquid contacting temperature range (°C)
General application (*1)	0.935	2	-40 to 40
High temperature application (-*2)	1.07	2	-5 to 90
High temperature & vacuum application (*3)	1.07	0.1333	-5 to 50
High temperature & high vacuum application (*4)	1.09	0.1333	-10 to 250
Oxygen application, chlorine application (*5)	1.87	53	-10 to 40

Remarks

1. An application where the pressure in the tank P_0 becomes a vacuum requires special caution.
2. If the above condition is not met, the pulling force applied to the diaphragm surface will exceed the specified range.

Foaming occurs because the pressure of sealed liquid exceeds the saturated vapor pressure and can cause zero point shifting. Negative pressure applied to the diaphragm can cause buckling and destroy the diaphragm.

3. When the liquid contacting temperature exceeds the levels shown in the table, the low limit of the allowable pressure also changes. Check the specifications.
4. *1. GTX□□R-□A
 *2. GTX□□R-□B
 *3. GTX□□R-□C
 *4. GTX□□R-□D
 *5. GTX□□R-□H&J

<Example of calculation>

Let's take up an example in which a remote seal type transmitter of the of the general specifications is used for a vacuum application (3kPa abs.)

- Liquid contacting pressure :Normal pressure (24°C)
- Low limit of allowable pressure (ρ) :2 kPa abs. (15mmHg abs.)
- Specific gravity of sealed liquid (ρ') :0.935
- Inner pressure of tank (ρ_0) :3kPa abs.

The condition that must be met to satisfy the transmitter specifications is as follows:

$$h \leq (P_0 - P) \times 102 / (\rho')$$

$$h \leq (3 - 2) \times 102 / 0.935 = 109mm$$

Therefore, the high limit of the transmitter position is 109mm.

2.3 : Piping AT9000 Advanced Transmitter

Summary

The actual piping arrangement will vary depending upon the process measurement requirements and the transmitter model. Except for flanged and remote diaphragm seal connections, process connections are made to 1/4 inch or 1/2 inch NPT female connections in the process head of the transmitter's meter body. For example, a differential pressure transmitter comes with double ended process heads with 1/4 inch NPT connections but they can be modified to accept 1/2 inch NPT through optional flange adapters.

The most common type of pipe used is 1/2 inch schedule 80 steel pipe.

Many piping arrangements use a three-valve manifold to connect the process piping to the transmitter. A manifold makes it easy to install and remove a transmitter without interrupting the process. It also accommodates the installation of blow-down valves to clear debris from pressure lines to the transmitter.

Figure 2-8 shows a diagram of a typical piping arrangement using a three-valve manifold and blow-down lines for a differential pressure transmitter being used to measure flow.

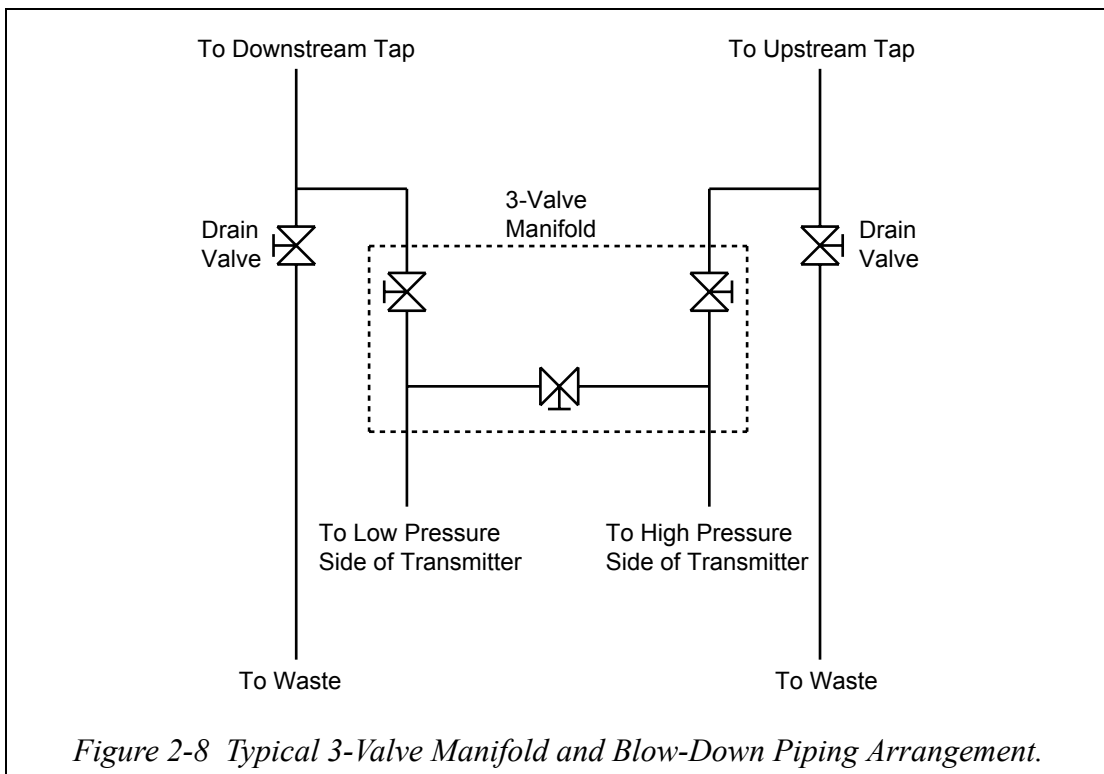

Process connections

Table describes typical process connections for a given type of transmitter.

Table 2-3 Process Connections

Transmitter type	Process Connection
Differential Pressure	Process heads with 1/4 inch NPT internal thread connection. Flange adapters and manifolds with 1/2 inch internal thread connections are optional.
Gauge Pressure	Process head with 1/2 inch NPT internal thread connection. Process heads with 1/4 inch NPT internal thread connection. (GTX□□G) Flange adapters and manifolds with 1/2 inch internal thread connections are optional (GTX□□G)
Absolute Pressure	Process heads with 1/2 inch NPT internal thread connection (GTX□□A)
Flange Mounted Liquid Level	1.5, 2 or 3 inches flange with flush or 2, 3 or 4 inches extended diaphragm on high pressure side. Reference side has standard differential pressure process head.
Remote Diaphragm Seals	See Model Selection Guide for description of available Flanged, Button-diaphragm (G1-1/2), and Wafer type process connections.

Installing flange Adapter

Table 2-4 gives the steps for installing an optional flange adapter on the process head.

Slightly deforming the gasket supplied with the adapter before you insert it into the adapter may aid in retaining the gasket in the groove while you align the adapter to the process head. To deform the gasket, submerge it in hot water for a few minutes then firmly press it into its recessed mounting groove in the adapter.

Table 2-4 Installing Adapter Flange

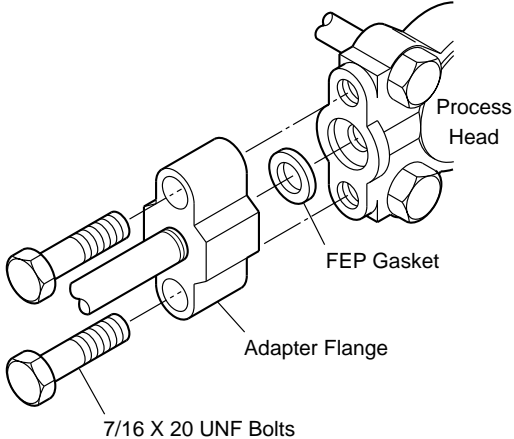
Step	Action												
1	Carefully seat FEP (white) gasket into adapter groove.												
2	Thread adapter onto 1/2 inch process pipe and align mounting holes in adapter with holes in end of process head as required.												
3	<p>Secure adapter to process head by hand tightening 7/16-20 UNF hexhead bolts. Example-Installing adapter on process head</p> <p>ATTENTION Apply an anti-seize compound on the stainless steel bolts prior to threading them into the process head.</p> 												
4	<p>Evenly tighten adapter bolts to the following torque;</p> <table border="1" data-bbox="435 1319 1377 1496"> <thead> <tr> <th>Adapter material</th> <th>CS/SS</th> <th>CS/SS</th> <th>PVC</th> </tr> </thead> <tbody> <tr> <td>Bolt material</td> <td>SNB7/SS630</td> <td>SS304</td> <td>SNB7/SS304</td> </tr> <tr> <td>Torque N•m</td> <td>20 ±1</td> <td>10 ±0.5</td> <td>7 ±0.5</td> </tr> </tbody> </table>	Adapter material	CS/SS	CS/SS	PVC	Bolt material	SNB7/SS630	SS304	SNB7/SS304	Torque N•m	20 ±1	10 ±0.5	7 ±0.5
Adapter material	CS/SS	CS/SS	PVC										
Bolt material	SNB7/SS630	SS304	SNB7/SS304										
Torque N•m	20 ±1	10 ±0.5	7 ±0.5										

2.3.1 :Piping for Liquid, Gas or Steam Flow Rate Measurement

Recommended Piping - Example 1

The illustration shows a typical example for liquid Flow Rate Measurement. This Differential pressure transmitter is located below the differential pressure output port of the process pipe. This minimizes the static head effect of the condensate.

The following apply:

Grade the pipe at the differential pressure output part.

Inclination symbol ∇ in illustration: Low level \triangle High level

After piping work, ensure that the connecting pipe, the 3-way manifold valve, and the transmitter have no pressure leak.

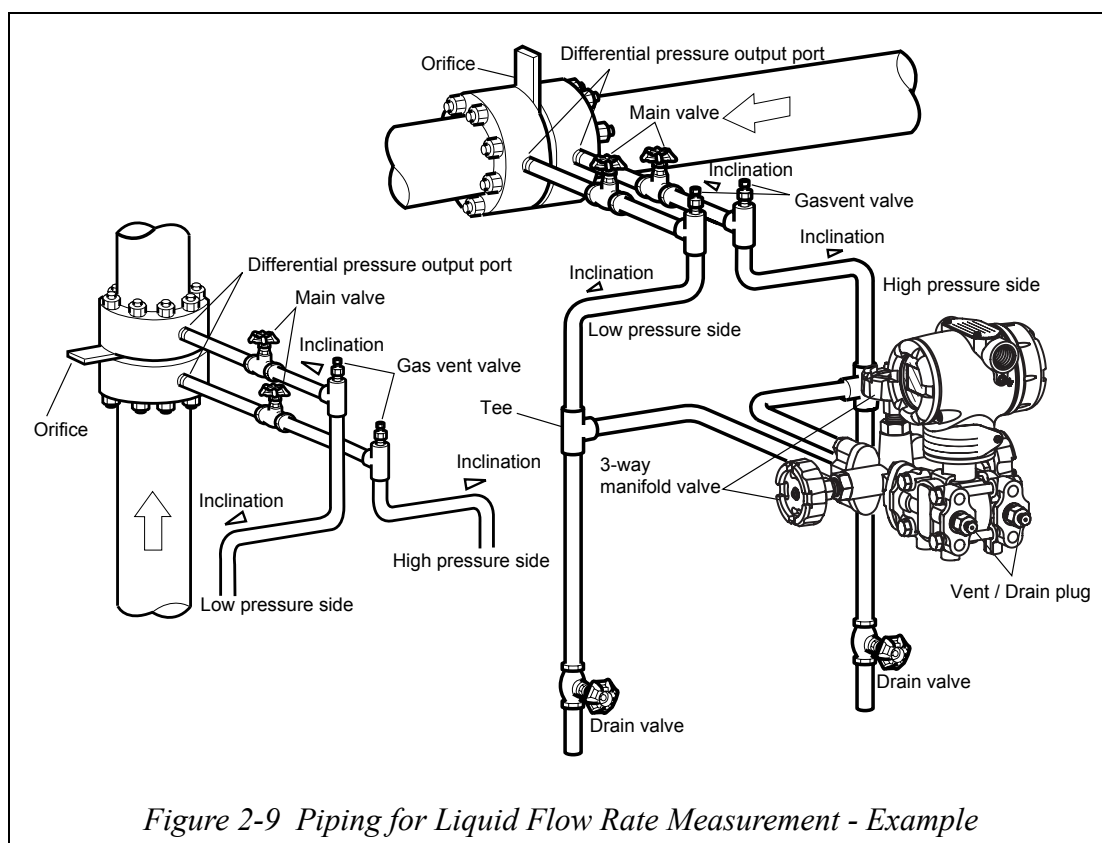

This transmitter is located underneath the differential pressure output port of the process pipe.

Recommended Piping - Example 2

The illustration shows a typical example for Gas Flow Rate Measurement. This Differential pressure transmitter is located above the differential pressure output port of the process pipe. The condensate drains away from the transmitter.

The following apply:

Grade the pipe at the differential pressure output part.

Inclination symbol in illustration: Low level High level

After piping work, ensure that the connecting pipe, check for pressure leaks around the 3-way manifold valve, and the transmitter.

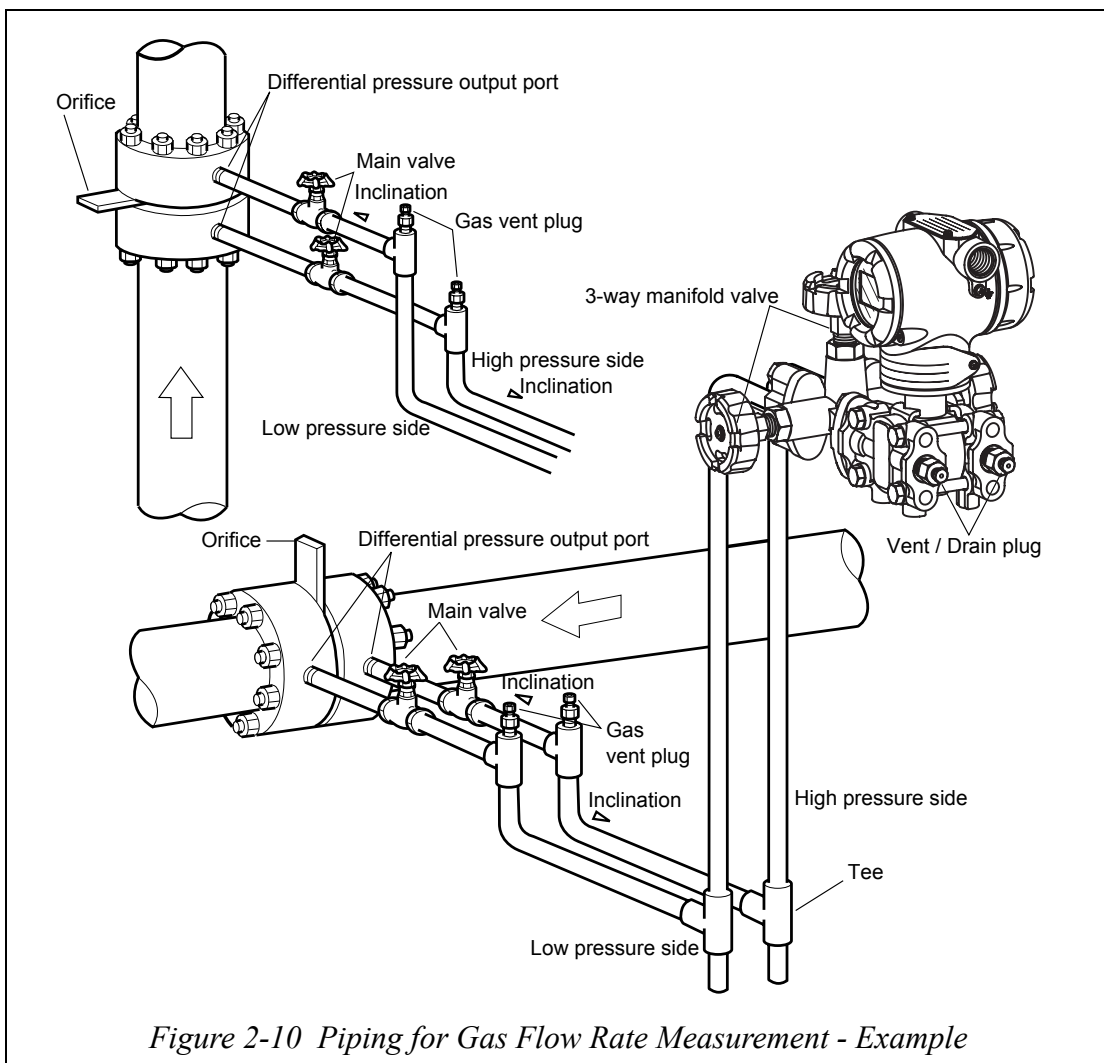

Figure 2-10 Piping for Gas Flow Rate Measurement - Example

This transmitter is located above the differential pressure output port of the process pipe.

Recommended Piping - Example 3

The illustration shows a typical example for Steam Flow Rate Measurement. Recommended for a Differential pressure transmitter located below the differential pressure output port of the process pipe.

The following apply:

Grade the pipe at the differential pressure output part.

Inclination symbol \triangleleft in illustration: Low level \triangleleft High level

After piping work, ensure that the connecting pipe, the 3-way manifold valve, and the transmitter have no pressure leaks.

If the process pipe is vertically mounted, mount seal pots at different levels to prevent zero drift. But in this case, you cannot apply the previously-used zero adjustment procedure (using a 3-way manifold valve). For zero shift occurring at different levels, use an HART® communicator.

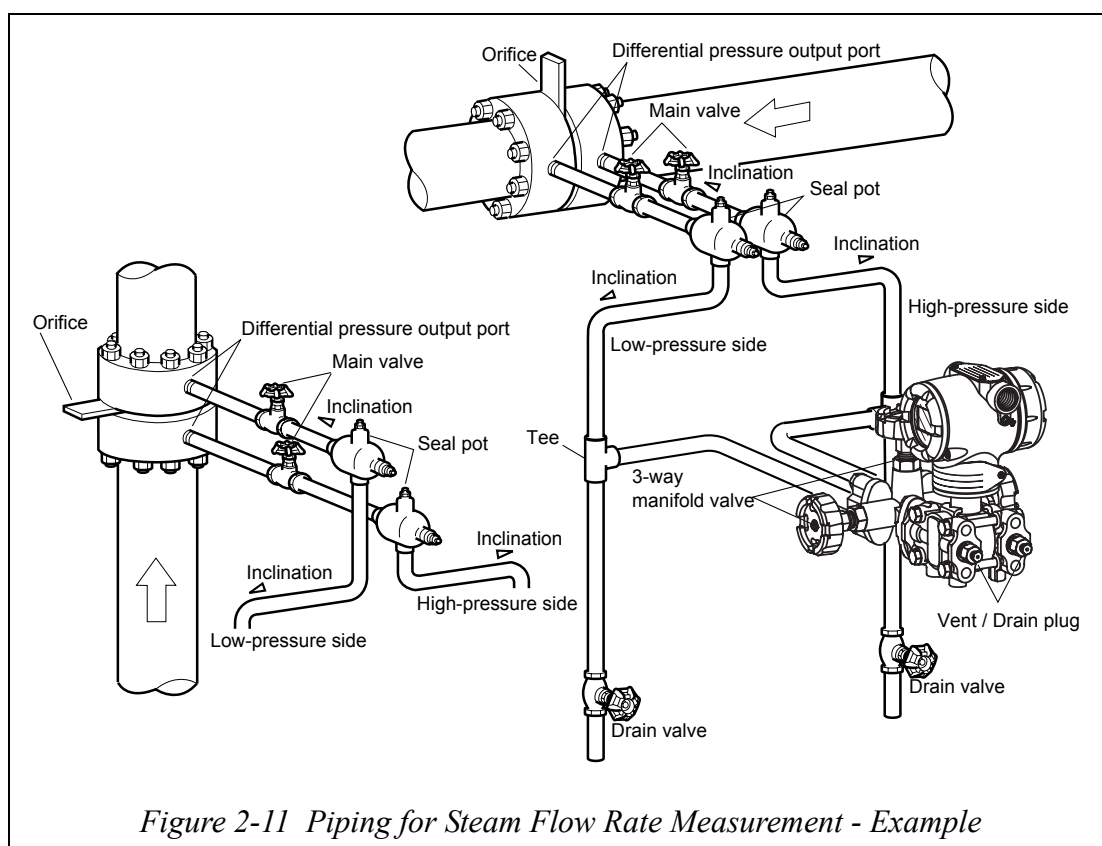

Figure 2-11 Piping for Steam Flow Rate Measurement - Example

This transmitter is located under the differential pressure output port of the process pipe.

2.3.2 :Pressure Measurement - Piping

Recommended piping - Example

For gas-pressure measurement, piping should be performed following the typical example shown here. Always observe these points:

After completing piping work, check for pressure leaks around connecting pipe and transmitter.

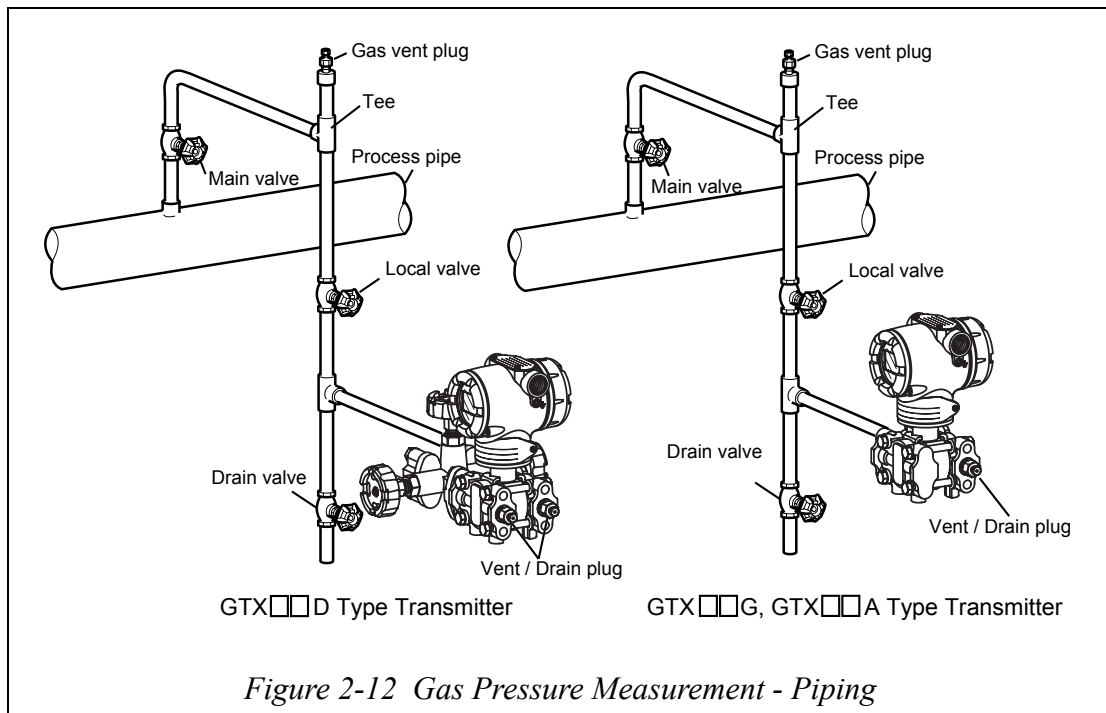

Piping method

The piping method for the fluid to be measured depends on the meter installation position and the pipe line state. Typical examples of piping are shown in Figure 2-13.

Connect pipes by the following procedure:

- (1) Use a T-shaped joint for the connecting pipeline.
- (2) Install a main valve between the entrance of the connecting pipe and the T-shaped joint.
- (3) If the process is a horizontal line, tilt the pipe to allow draining from the pressure line.

~Note *In case of a high pressure process, select a joint of appropriate specifications and shape and a pipe of appropriate shape and material with care.*

- (4) Determine the connecting pipe schedule number and the nominal thickness of the connecting pipe from the process based on conditions such as the process pressure.

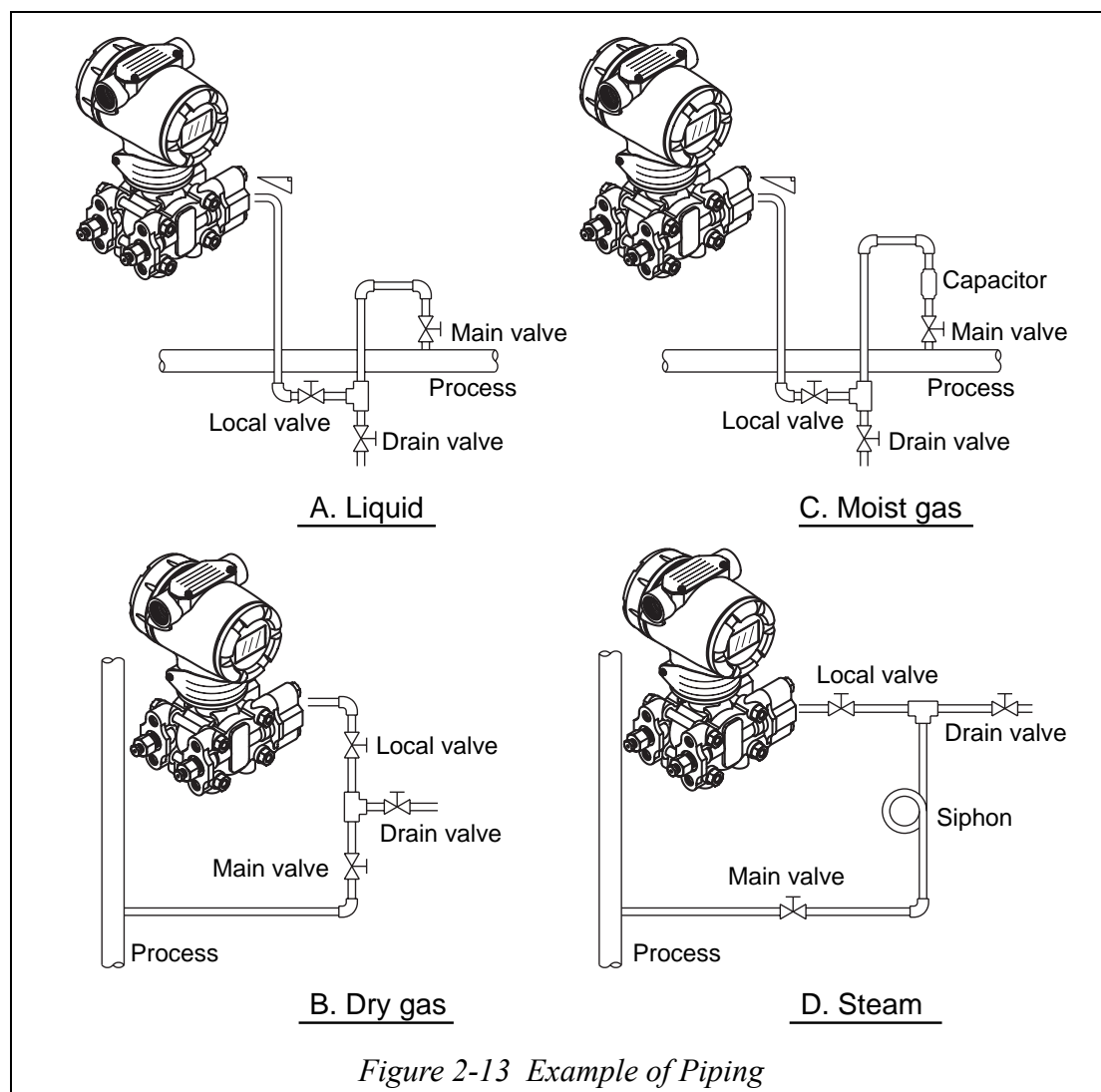

Auxiliary equipment

- (1) Oil sealing and air purging

If the pressure medium (such as suspension, high viscosity, and corrosive fluid) should not be led directly to the element, avoid it by means of sealing or purging. Various sealing and purging methods are available. Consult us for each case.

- (2) Preventing pulsations

If the process has serious pulsations or great pressure fluctuations, provide a throttle valve in the middle of the connecting pipe to prevent pulsations.

2.3.3 :Liquid Level Measurement - Piping (GTX__D/GTX__G)

Piping

Introduction

For measurement by GTX__D type of liquid level in a tank, the piping method depends on whether the tank is open or closed. For closed tanks, piping is modified according to whether you use the gas sealing method (dry leg) or the liquid sealing method (wet leg).

H mark

H indicating high pressure is marked on the center body of this transmitter. Check the mark during piping work. The low-pressure side has no mark.

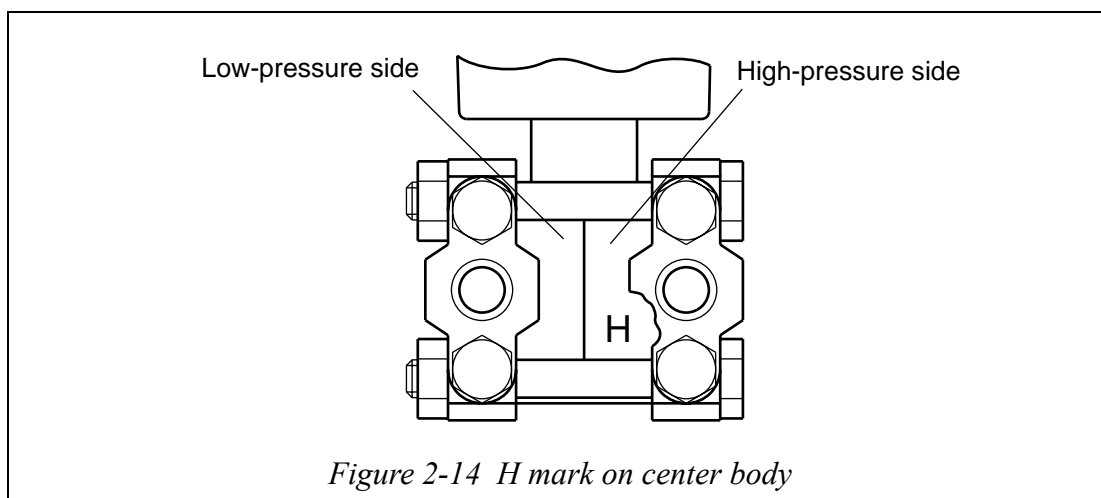

Figure 2-14 H mark on center body

Before your start

The following parts are requirements for piping work. Refer to illustration.

- 3-way manifold valve
- Pipe
- Main valve
- Union or flange
- Tee
- Drain valve
- Drain plug
- Seal pot (for closed tank and wet-leg only)

Open Tank - Piping

Recommended piping - Example

For open tanks, connect the high-pressure side of this transmitter to the lower part of the tank. Open the low-pressure side to the air.

After completing piping work, check for pressure leaks around the connecting pipe, the transmitter, and the 3-way manifold valve. The illustration shows a typical installation.

Connect the high-pressure side of this transmitter to the lower part of the tank.

Install this transmitter below the lowest liquid level to be measured.

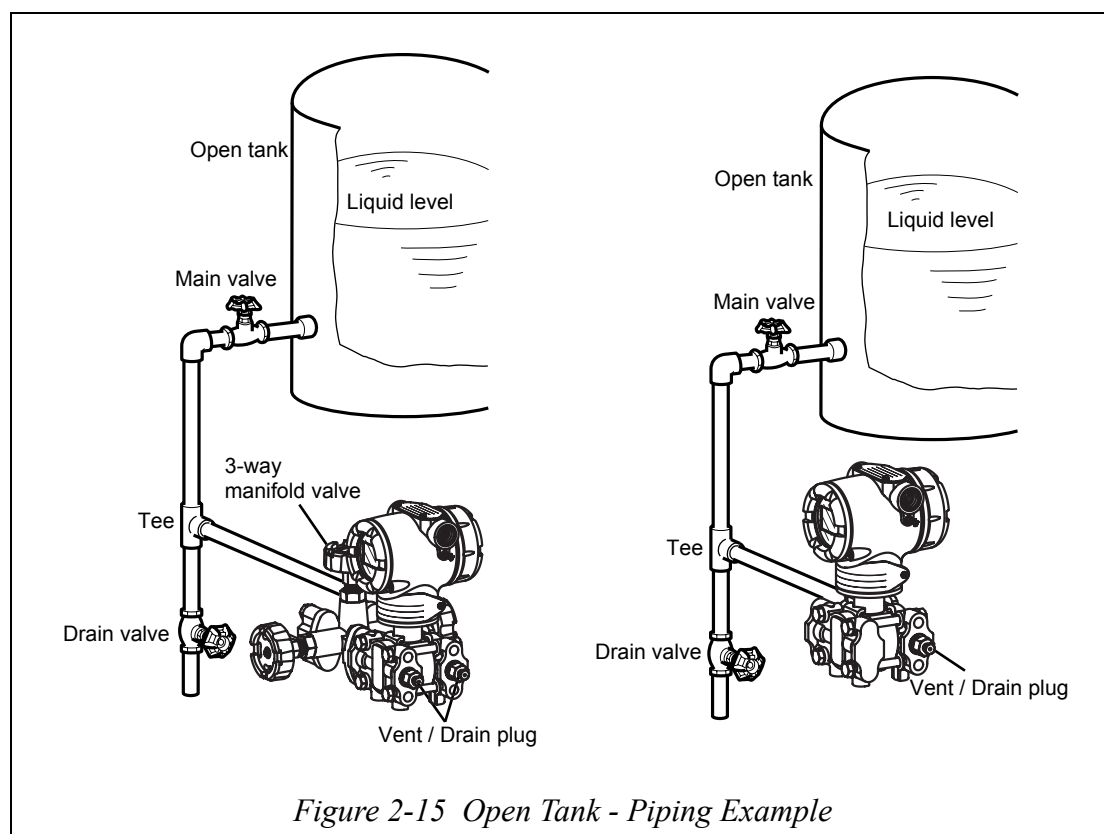

Figure 2-15 Open Tank - Piping Example

Closed Tank - Piping

Recommended piping for dry leg - Example

When using the dry-leg method, connect the high-pressure side of the transmitter to the lower part of the tank. Connect the low-pressure side to the gas-sealing pipe of the tank.

After completing piping work, check for pressure leaks around the connecting pipe, the transmitter, and the 3-way manifold valve. The following shows a typical installation.

Always connect the high-pressure side of this transmitter to the lower part of the tank. Install this transmitter below the lowest liquid level to be measured.

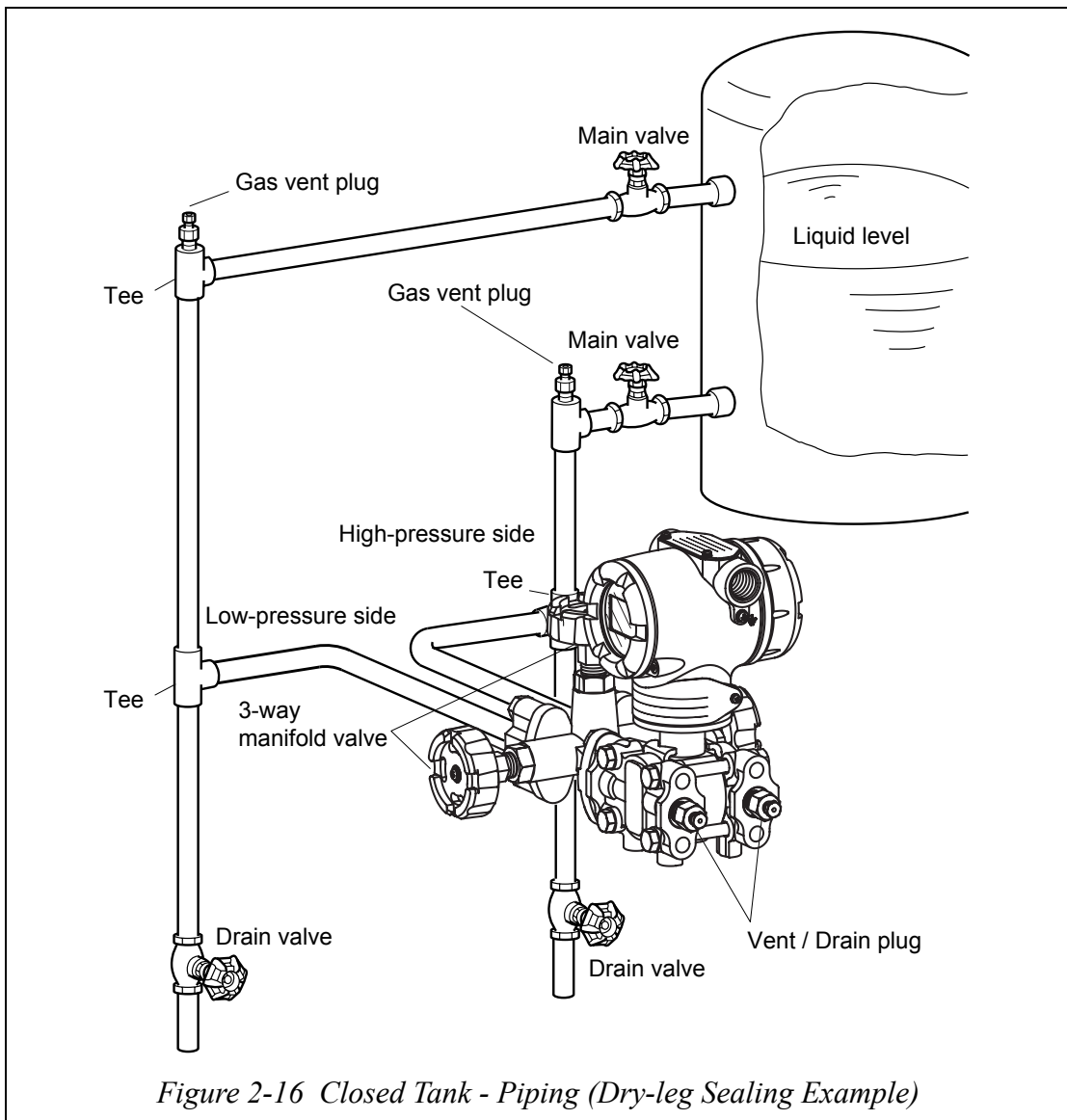

Recommended piping for wet leg - Example

When using the wet-leg method, connect the high-pressure side of the transmitter to the sealing pipe of the tank. Connect the low-pressure side to the lower part of the tank.

After completing piping work, check for pressure leaks around the connecting pipe, the transmitter, and the 3-way manifold valve. The illustration shows a typical installation.

Be sure to connect the low-pressure side of this transmitter to the lower part of the tank.

Install this transmitter below the lowest liquid level to be measured.

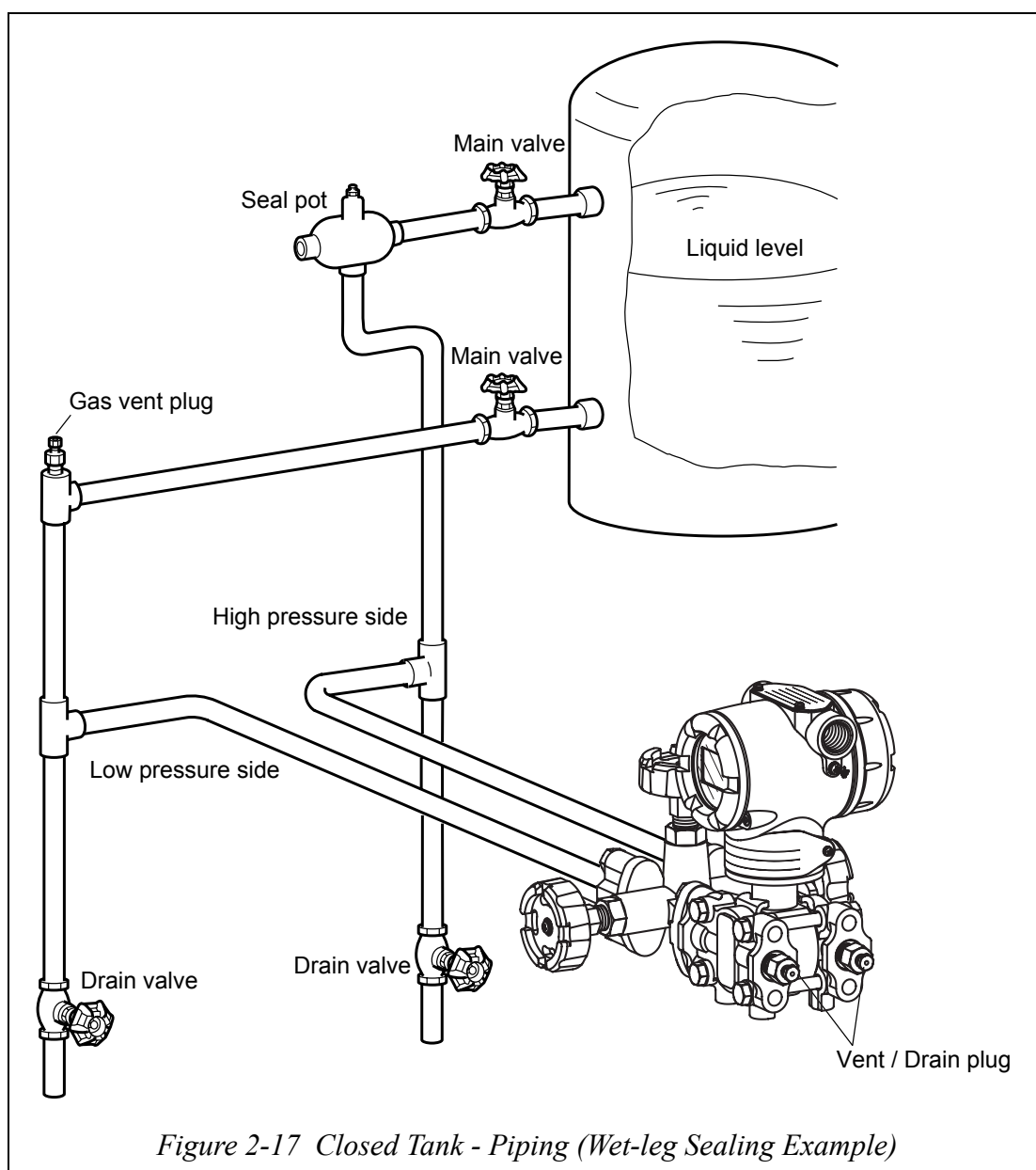

Figure 2-17 Closed Tank - Piping (Wet-leg Sealing Example)

ATTENTION

For liquid or steam, the piping should slope a minimum of 25.4 mm (1 inch) per 305 mm (1 foot). Slope the piping down towards the transmitter if the transmitter is below the process connection so the bubbles may rise back into the piping through the liquid. If the transmitter is located above the process connection, the piping should rise vertically above the transmitter, then slope down towards the flowline with a vent valve at the high point. For gas measurement, use a condensate leg and drain at the low point (freeze protection may be required here).

2.4 : Wiring AT9000 Advanced Transmitter

2.4.1 :Wiring for Transmitter -- Regular Model

Introduction

Following wiring instructions when no explosion-proof standards apply.

Wire and cable this transmitter as shown in the illustrations.

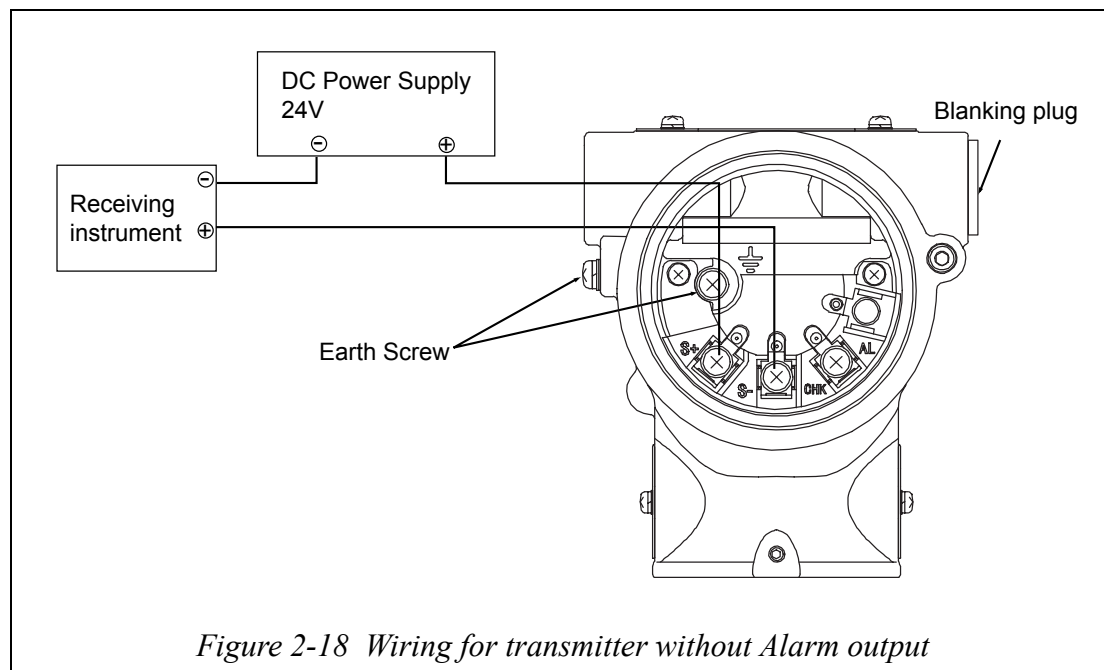

- ~Note**
1. External load resistance of at least 250Ω required for communications with an HART® communicator. If total load resistance of the receiving instrument is less than 250Ω insert the necessary resistance to the loop.
 2. In using Yamatake's field type indicator (Model NWS300, Model NWA300), please consult us.
 3. A blanking plug may not be used on the adapter or elbow.

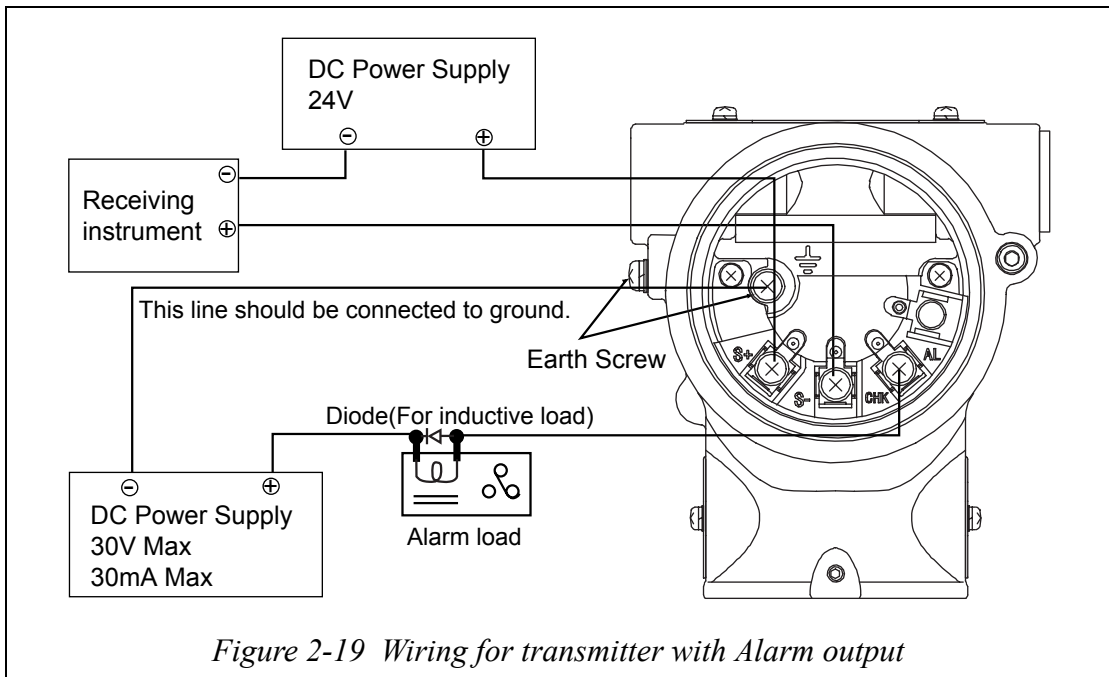

~Note *Current cannot checked for a transmitter with alarm contact output.*

Cable Specification

Use standard lead wires or cables that are the same as, or better than 600V grade PVC insulated wires.

Standard Models or Explosionproof Models

Use wiring rated for at least 5 deg.C higher than ambient temperature.

Intrinsically Safe Models

Use wiring rated for at least 10 deg.C higher than ambient temperature.

Conduit pipe for cables

Lead cables into the transmitter case, as follows:

Mount a conduit pipe in the conduit hole (1/2NPT female thread) provided on the side of a transmitter, and lead cables through the pipe.

Seal the part that contacts with the conduit pipe. Use a sealing agent or a seal plug to prevent entry of water.

Install transmitter so that the cables lead into it, from the bottom.

Grounding

If a shielded cable is used, earth (ground) the shield at the receiver only (single point ground). Connecting the shield to signal ground is recommended to make the electric potential difference lower.

If the transmitter is not grounded through a pipe stanchion, ground the transmitter using an earth terminal in the transmitter.

To ground the transmitter, the ground resistance must be 100Ω or lower.

External Earthing or Bonding Connection

The connection of the earthing or equipotential bonding conductor with the external grounding terminal must comply with the following method.

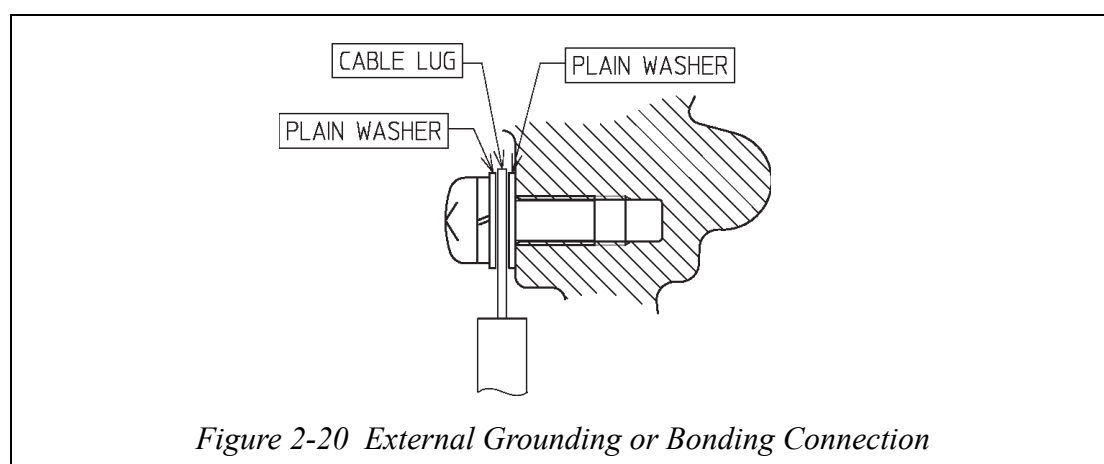

Supply power and external load resistance

Confirm the relationship between the external load resistance and the supply voltage. As shown in the illustration, the relationship should be inside the shaded area.

External resistance: the total resistance connected to the output terminals of a transmitter (includes resistances of all cables in the loop plus the internal resistance of the instruments).

The horizontal axis represents the supply voltage of a transmitter, and vertical axis represents the external load resistance

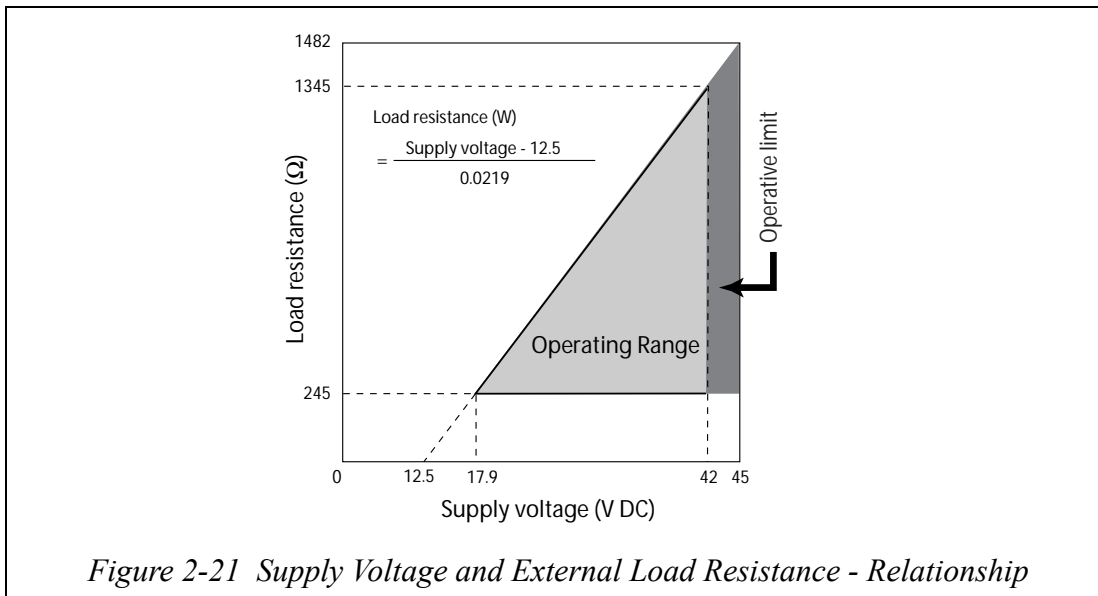

Figure 2-21 Supply Voltage and External Load Resistance - Relationship

- ~Note
1. 45 volt operation is permitted.
 2. For communication with HART® communicator, a load resistance of 250 Ω or more is needed.

Summary

For wiring the transmitter, you simply connect the positive (+) and negative (-) loop wires to the positive (+) and negative (-) signal terminals on the terminal block in the transmitter’s electronics housing as shown in Figure 2-22.

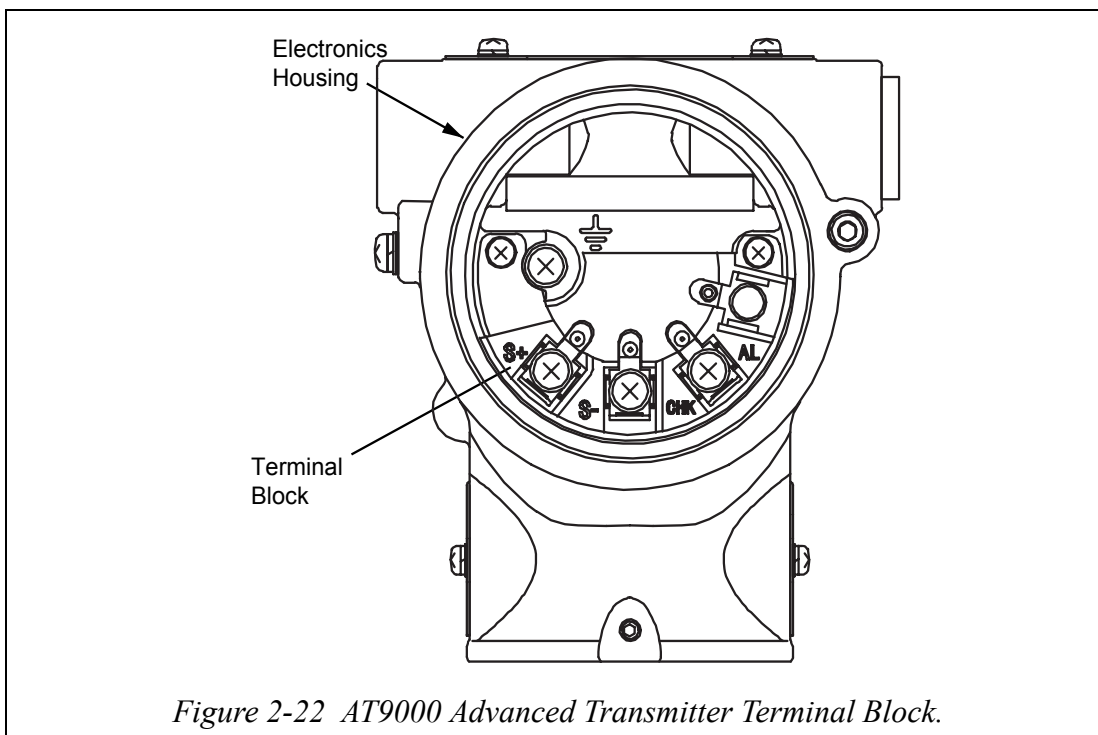

Figure 2-22 AT9000 Advanced Transmitter Terminal Block.

Chapter 3 : Operation of the Transmitter

3.1 : Preparation

Instructions for connecting HART® Communicator to this transmitter.

Basic instructions for Key-pad operation.

3.1.1 :Connecting communicator

You connect the communicator directly to signal terminals on the transmitter's terminal block or at any location in the 4 to 20 mA loop. (Polarity of the communicator connection does not matter)

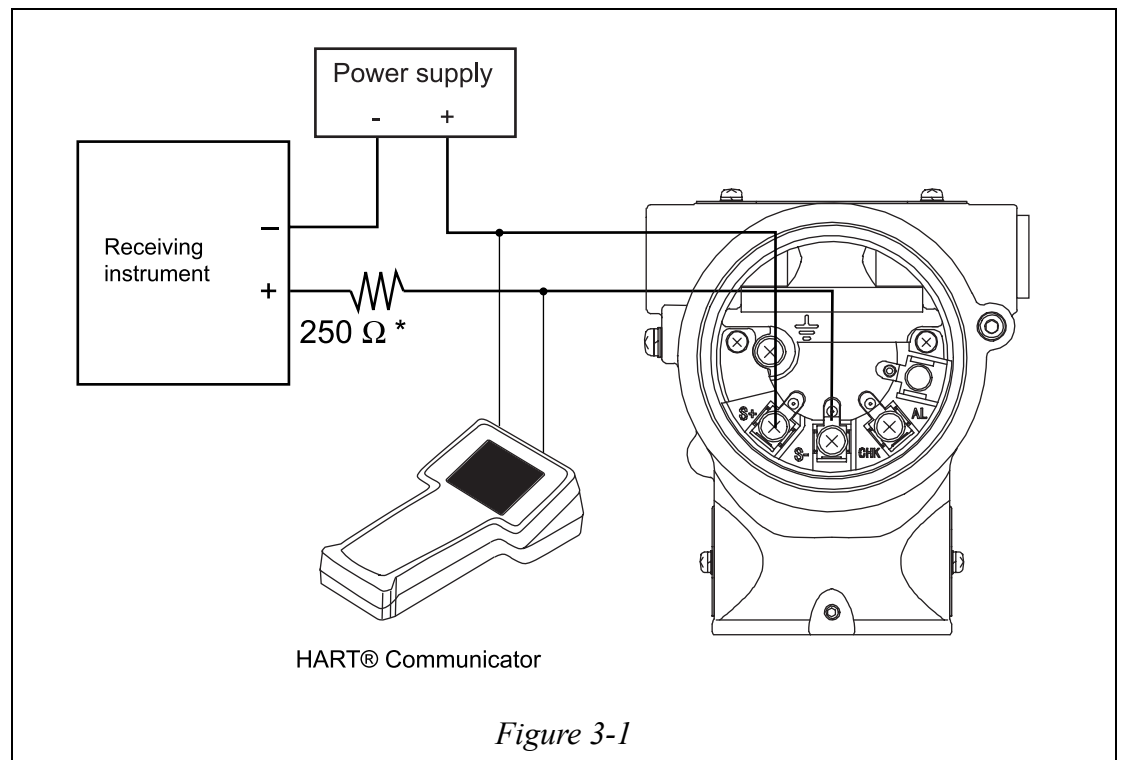

3.1.2 :HART® 375 FIELD COMMUNICATOR keyboard



3.1.3 :Symbols on communicator screen

See manual of 375 FIELD COMMUNICATOR.

3.1.4 :Keying in alphanumeric characters

See manual of 375 FIELD COMMUNICATOR.

3.2 : Setting and Checking Specifications

3.2.1 :Establishing Communications

This procedure starts communications between the transmitter and the communicator:

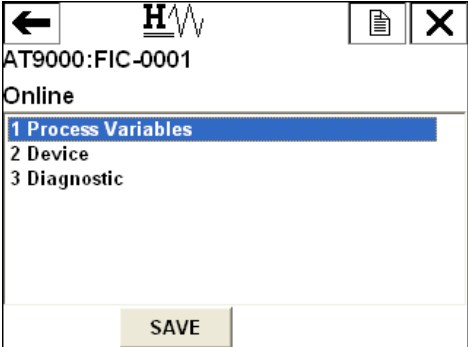
STEP	Action and/or Description
1	Turn on communicator. The communicator runs a self-test check then determines if it is connected to a transmitter.
2	<p>If you receive a communication error message (No Device Found), check the following:</p> <ul style="list-style-type: none"> • Loop resistance: Is there a minimum of 250 Ω resistance between the communicator and the power supply? • Power supply: Is power applied? Is there greater than 11 volts at the transmitter? <p>Correct any problems, and try communicating again. If the message, or any other error message, appears again, refer to “Chapter 6: Troubleshooting”.</p>
3	<p>When the “Online” display - shown below - appears, you have established communication with the transmitter.</p> <div style="text-align: center;">  </div> <p>The flashing heart icon in the upper right corner indicates the communicator and the transmitter are communicating.</p>

3.2.2 :Setting Tag No.

Procedure

This shows how to change or enter tag number.

(Device) - (Basic Setup) - (Tag)

After entering a tag number with pressing ENTER, press SEND to download the change to the transmitter.

3.2.3 :Checking Output Format

Procedure

This shows how to change output format, which linear calculation or square root calculation

used for measuring differential pressure between a primary element with DP type transmitter.

(Device) - (Basic Setup) - (Transfer Function)

3.2.4 :Checking Display Setting

Procedure

This shows how to configure display format and/or its ranges.

(Device) - (Display)

Menu items when Display Mode is%:

- 1 Display Mode
- 2 Display Function
- 3 Transfer Function

Menu items when Display Mode is pressure:

- 1 Display Mode
- 2 Transfer Function

Menu items when Display Mode is scale:

- 1 Display Mode
- 2 Display Function
- 3 Transfer Function
- 4 EULO (0%)
- 5 EUHI (100%)
- 6 Disp. Unit
- 7 User Unit
- 8 Exponent

3.2.5 :Display Mode

%:	Displaying PV with%
pressure:	Displaying PV with pressure unit
scale:	Displaying scaling PV

3.2.6 :Display Function

Linear:	Displays linear.
Square root:	Displays flow by square root extraction.

3.2.7 :Checking Engineering Unit of Measured Pressure

Procedure

This function is to check a pressure unit of the transmitter.

(Device) - (Display) - (Disp. Unit)

inH₂O

inHg

mmH₂O

psi

bar

mbar

g/Sqcm

kg/Sqcm

mmHg

Pa

kPa

MPa

3.2.8 :Checking Low and High Limits of Setting Range

Procedure

This is to configure the measuring range of the transmitter.

(Device) - (Basic Setup)

- Select Lower Ranges Value (0%) or Upper Range Value (100%) to key in the desired setting.

- Press ENTER. This takes you back to “Basic Setup” menu.

- Press SEND to download change to transmitter.

If the number of digits you key in is more than four, the set range will not on “Basic Setup” menu.

LRL and URL are to refer only.

3.2.9 :Adjusting Damping Time Constant

Procedure

You can adjust the damping time to reduce the output noise.

(Device) - (Signal Condition) - (Damping)

When in the PV damping menu, key in appropriate damping time from 0.0 to 128.0, and the press ENTER. A display will prompt when you enter the value out of range that the value is out of range.

3.2.10 :Checking Fill fluid temperature compensation

Procedure

This function implemented by inputting the height between the flanges on which the transmitter is mounted.

(Device) - (Signal condition) - (Height)

Key in the height between the flanges in meter.

When communicating with the transmitter without this function, the screen shows “0.00 m”.

Keying in “0” disables the function.

Sealed liquid temperature correction function

When the liquid level of a tank is measured using a remote sealing type differential pressure transmitter, the density of the sealed liquid in the capillary tube changes as the ambient temperature changes. This ordinarily causes about 4~5% zero shifting.

The GTX□□R has a composite semiconductor sensor with a function for correcting sealed liquid temperature by means of temperature measurement and arithmetic operation with a microprocessor. This assures accurate level measurements. (The zero shift is reduced to 1/5 from the previous level.)

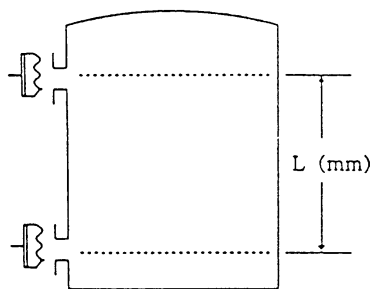

Example of zero shift

L (Difference between flanges): 2500 mm (2.5 m)

R (Measurement span): 2500 mm (2.5 m)

A (Temperature coefficient of sealed liquid):0.001/°C

T (Ambient temperature change): 55°C

$$\text{Zero shift} = \frac{A \times T \times L}{R} \times 100 \dots (1)$$

From (1)

Zero shift of a model without temperature correction:

$$\frac{0.001 \times 55 \times 2500}{2500} \times 100 = 5.5 \%$$

(Conventional transmitter)

Zero shift of a model with temperature correction

function: 1%

3.3 : Measurement with model GTX__D

3.3.1 :Flow Rate Measurement

Preparation for Measurement

⚠ WARNING

- Make sure that the process is in the manual control mode.
If in automatic control mode, switch to manual control before starting the following procedures.
- Drain poisonous fluids with care, making provisions to protect personnel.
- Always close the differential pressure output valve (main valve), the drain valve, the gas vent plug (Refer to Figure 2-9 and Figure 2-10) and the high pressure side and low pressure side stop valves of the 3-way manifold valve. Also, open the equalizer valve of the 3-way manifold valve.

Procedure 1

Lead process pressure into the pressure receiving part of the transmitter, using this procedure:

Step	Description
1	Gradually open the main valves of both the high-pressure side and the low-pressure side (Refer to Figure 2-9 and Figure 2-10). Lead process fluid into the connecting pipe.1
2	<p>Fill with process fluid, the pressure-receiving part of the transmitter.</p> <ol style="list-style-type: none"> 1. Gradually open the high pressure side stop valve. Close, after the pressure receiving part has completely filled with process fluid. 2. Gradually open the low pressure side stop valve. Close, after the pressure receiving part has completely filled with process fluid.

The diagram shows a 3-way manifold valve assembly. It features a central body with two main ports: a 'High-pressure side' on the left and a 'Low-pressure side' on the right. A '3-way manifold valve' is integrated into the assembly. An '(Equalizer valve)' is located at the top of the manifold. A '(Low-pressure side stop valve)' is positioned on the low-pressure side. A 'Vent / Drain plug' is located at the bottom right of the assembly.

Step	Description
3	Decrease to zero, the differential pressure applied to the transmitter. <ul style="list-style-type: none"> • Gradually open the high-pressure side stop valve to lead process pressure into the pressure receiving part of the transmitter. • In this state, equal pressure is applied to the high-pressure side and the low-pressure side of the transmitter (equal pressure state).
4	Check for pressure leaks in the connecting pipe, the 3-way manifold valve, and the transmitter.

Procedure 2

Perform zero-point calibration, using this procedure:

Zero point calibration by HART® communicator operation

Check that the transmitters input is 0 kPa and its output is 0% at Online display. (Refer to "3.2.1 : Establishing Communications").

If the screen display is not 0 kPa perform zero-point calibration using this procedure.

 **CAUTION**

If damping time constant is set to 0 sec. please adjust another value to keep the output stable before calibration. (Refer to "3.2.9 : Adjusting Damping Time Constant")

(Device)-(Calibration) - (Correct Input)

- Select “Zero Trim”.
- You will be warned to remove the loop from automatic control. After doing so,
- press OK.
- When prompted, adjust pressure source to apply pressure equal to zero, then press OK.
- When pressure is stable, press OK.

Starting Measurement

Procedure 3

Apply the differential pressure of the process by operating valves, using this procedure.

How to apply process pressure

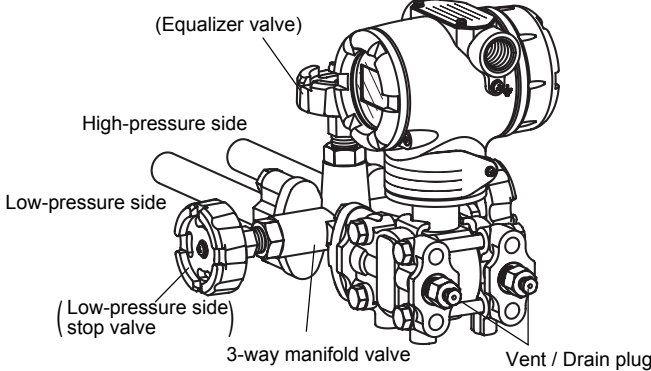
Step	Description
1	Ensure that the 3-way manifold valve is in the following state: <ol style="list-style-type: none"> 1. High-pressure side stop valve: Fully open 2. Low-pressure side stop valve: Fully closed 3. Equalizer valve: Fully open
2	<ol style="list-style-type: none"> 1. Close the equalizer valve. 2. Open the low-pressure side stop valve gradually. 

CAUTION

Securely close the cover of the transmitter case. Imperfect closure allows entry of water, and may damage internal terminals as well as the electronics module. Such damage may require parts replacement, possibly of the entire module.

- If input and output values do not match, check the range and re-calibrate.
- If the displayed data value is unstable, adjust the damping time constant.

Stopping Measurement

Procedure

Stop the transmitter, using this procedure:

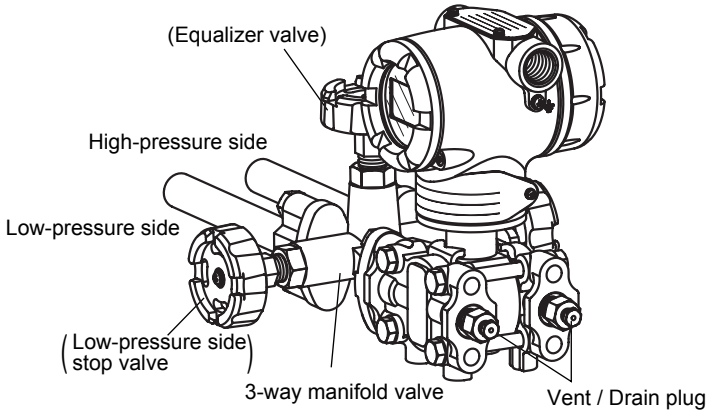
Step	Description
1	Turn off the transmitter
2	<p>Operate the 3-way manifold valve by the following procedure:</p> <ol style="list-style-type: none"> 1. Close the low-pressure side stop valve. 2. Open the equalizer valve. 3. Close the high-pressure side stop valve 
3	Close the main valves on the high and low pressure sides. Refer to Figure 3-9 and Figure 3-10.

CAUTION

- If you plan to leave the transmitter OFF for a long period of time, always drain process fluid from the connecting pipe and the pressure-receiving part.
- Leave the equalizer valve open.

3.3.2 :Gas Pressure Measurement

Preparation for Measurement

WARNING

-
- Ensure that the process is in the manual control mode.
If the process is in automatic control mode, switch to manual before starting the procedure.
 - Drain poisonous fluids with care, making provisions to protect personnel.
 - Close the differential pressure output valve (main valve), the local valve, the drain valve, and the gas vent plug. Refer to "Figure 2-12 Gas Pressure Measurement - Piping".
-

How to measure gas pressure

Perform zero-point adjustment and introduce process pressure into the transmitter, using this procedure:

- Zero-point adjustment

Step	Description
1	Open both the high-pressure side and low-pressure side vent plugs and open the pressure receiving part to the air.
2	Refer to procedure 2 on page 3-8. Perform zero-point calibration.
3	After completing zero-point calibration, close the high-pressure side vent plug.

Introducing process pressure and venting air

Step	Description
1	1. Open the main valve (refer to "Figure 2-12 Gas Pressure Measurement - Piping".) to introduce process pressure into the connecting pipe. 2. Open the local valve gradually, to introduce process pressure into the pressure-receiving part of the transmitter.
2	1. Open the high-pressure side vent plug gradually, to vent air from the center body. 2. After venting air, close the vent plug and the local valve.
3	Check for pressure leaks in the connecting pipe and the transmitter.

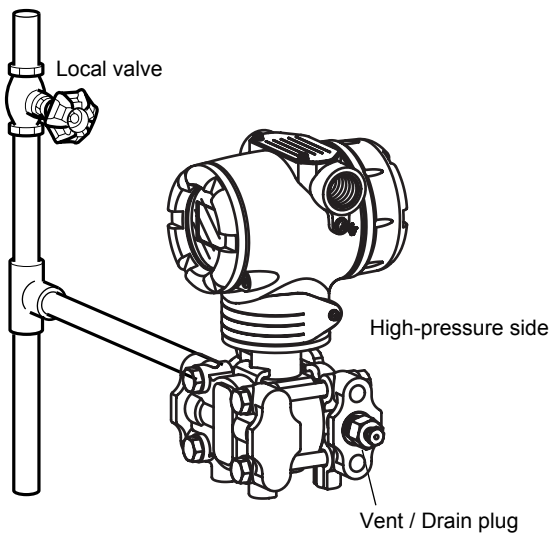

Starting Measurement

Procedure

Operate the valves using this procedure, to apply process pressure to the transmitter.

- How to apply process pressure

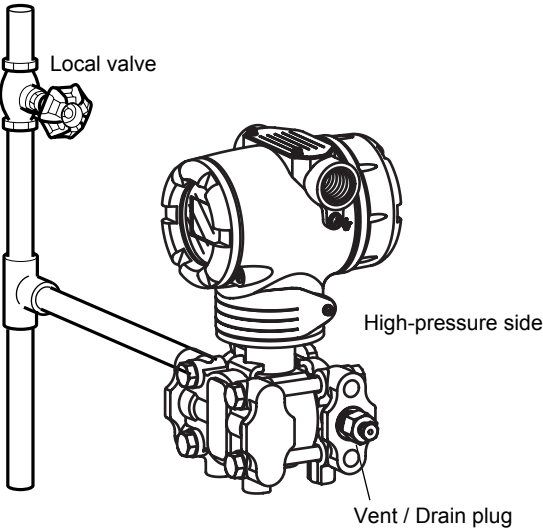
Step	Description
1	<p>Open the local valve gradually.</p>  <p>The diagram illustrates the transmitter's connection to a process pipe. A vertical pipe has a 'Local valve' at the top. A horizontal pipe connects this valve to the 'High-pressure side' of the transmitter. The transmitter is shown with its protective cover. At the bottom of the transmitter, there is a 'Vent / Drain plug'.</p>

CAUTION

Securely close the cover of the transmitter case. Failure to do so will result in entry of water, and cause damage to internal terminals and the electronics module.

- If input and output values fail to match, check the range and re-calibrate.
- If the displayed data value is unstable, adjust the damping time constant.

Stopping Measurement

Procedure

How to stop the transmitter

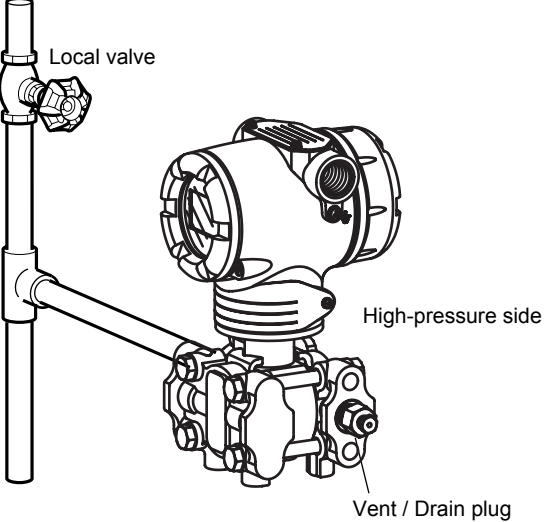
Step	Description
1	Turn off the transmitter.
2	Close the local valve. <div style="text-align: center; margin-top: 20px;">  <p>The diagram shows a vertical pipe on the left with a 'Local valve' (a handwheel) on its side. A horizontal pipe connects this vertical pipe to the 'High-pressure side' of a transmitter. The transmitter has a protective cap on top and a 'Vent / Drain plug' on the bottom right side.</p> </div>
3	Close the main valve. (Refer to "Figure 2-12 Gas Pressure Measurement - Piping".)

⚠ CAUTION

If you plan to leave the transmitter OFF for a long period of time, completely drain process fluid from the connecting pipe, and from the pressure receiving part.

3.3.3 : Liquid Level Measurement of Open Tank and Closed Tank (Dry Leg)

Preparation for Measurement

WARNING

-
- Place the process in the manual control mode.
If the process is in the automatic control mode, switch to manual before performing work.
 - Drain poisonous fluids carefully, taking provisions to protect workers.
 - Check that the differential pressure output valve (main valve), the drain valve, the gas vent plug (refer to "Figure 2-15 Open Tank - Piping Example".) are closed, as well as the high pressure side and low pressure side stop valves of the 3-way manifold valve. Also, make sure that the equalizer valve of the 3-way manifold valve is open.
-

Calculating setting range

Calculate the setting range. Refer to "3.8 : Set Range Calculation for Liquid Level Measurement".

Procedure

Perform zero-point adjustment and introduce process pressure into the transmitter by this procedure:

Zero-point calibration

Step	Description
1	Open the drain plugs and the stop valves of both the high-pressure side and the low-pressure side. Open the pressure receiving part to the air. If fluid remains in the pressure receiving part, blow it to drain.
2	Refer to procedure 2 in page 3-8 and perform zero-point calibration.
3	After completing zero-point calibration, close the high-pressure side drain plug and the high-pressure side stop valve.

Introducing process pressure

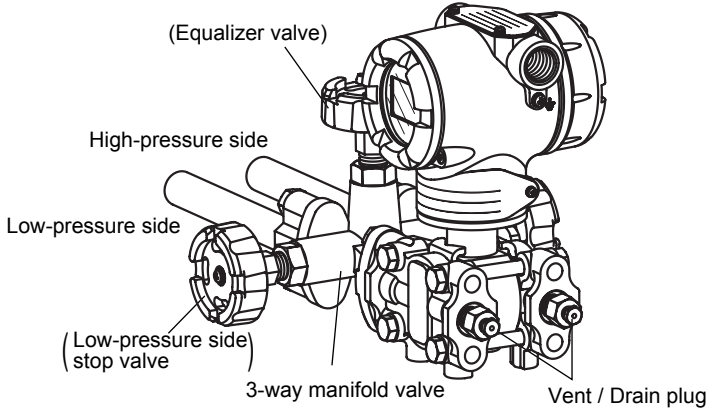
Step	Description
1	<p>1. Open the main valve (refer to "Figure 2-15 Open Tank - Piping Example") to introduce process pressure into the connecting pipe.</p> <p>2. Open the high-pressure side stop valve gradually to introduce process pressure. After introducing process pressure into the pressure receiving part of the transmitter, close the high-pressure side stop valve.</p> 
2	<p>Check for pressure leaks in the connecting pipe, the 3-way manifold valve, and the transmitter.</p>

Starting Measurement

Procedure

Operate the valves with this procedure, to apply the differential pressure of the process to the transmitter.

How to apply process pressure

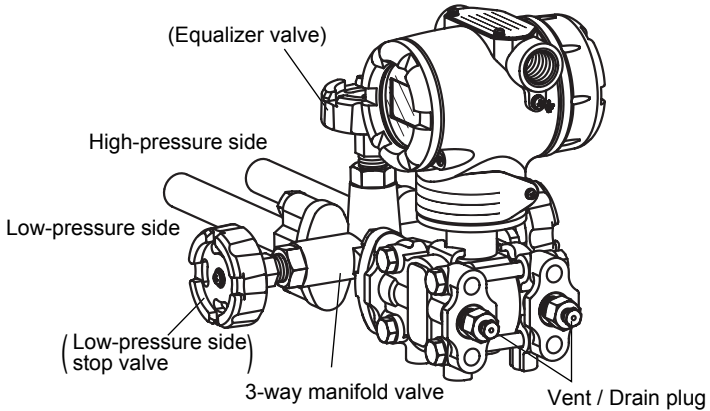
Step	Description
1	<p>Check that the 3-way manifold valve is in the following state:</p> <ol style="list-style-type: none"> 1. High-pressure side stop valve: Fully closed 2. Low-pressure side stop valve: Fully open 3. Equalizer valve: Fully closed 
2	<ol style="list-style-type: none"> 1. Open the high-pressure side stop valve gradually.

CAUTION

Securely close the cover of the transmitter case. Failure to do so will result in entry of water, and cause damage to internal terminals and the electronics module.

- If the input and output values do not match, check the range and re-calibrate.
- If the displayed data value is unstable, adjust the damping time constant.

Stopping Measurement

Procedure

How to stop the transmitter

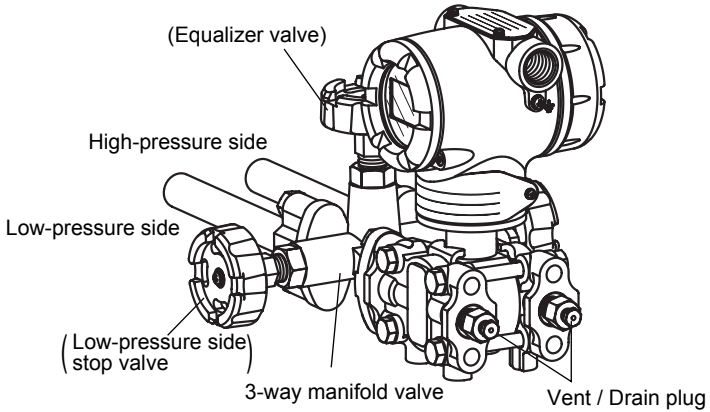
Step	Description
1	Turn off the transmitter.
2	<p>Operate the 3-way manifold valve using this procedure:</p> <ol style="list-style-type: none"> 1. Close the low-pressure side stop valve. 2. Open the equalizer valve. 3. Close the high-pressure side stop valve. 
3	Close the main valve. Refer to "Figure 2-15 Open Tank - Piping Example".

CAUTION

- If you plan to leave the transmitter OFF for a long period, drain process fluid from the connecting pipe and the pressure receiving part.
- Leave the equalizer valve open.

3.3.4 :Liquid Level Measurement of Closed Tank (Wet Leg)

Preparation for Measurement

WARNING

-
- Place the process in manual control mode.
If the process is in automatic control mode, change it to the manual control mode before performing this work.
 - Drain poisonous fluids with care, making provisions for protecting workers.
 - Make sure that the differential pressure output valve (main valve), the drain valve, the gas vent plug (refer to "Figure 2-17 Closed Tank - Piping (Wet-leg Sealing Example)".) and the high pressure side and low pressure side stop valves of the 3-way manifold valve are closed. Also, make sure that the equalizer valve of the 3-way manifold valve is open.
-

Calculating setting range

For the procedure for obtaining the setting range by calculation, refer to "3.8 : Set Range Calculation for Liquid Level Measurement".

Procedure

Perform zero-point adjustment and introduce process pressure into the transmitter using this procedure:

Zero-point calibration

Step	Description
1	Feed sealing liquid from the seal pot to fill the connecting pipe with sealing liquid.
2	Gradually open the stop valves of both the high-pressure side and the low-pressure side, and the drain plugs, to fill the pressure receiving part of the transmitter with sealing liquid.
3	When sealing liquid flows out from the drain plugs, close the stop valves of both the high pressure side and the low pressure side and the drain plugs. In this state, the same pressure is applied to the high pressure side and the low pressure side of the transmitter (equal pressure state).
4	Referring to procedure 2 in page 3-8, perform zero point calibration.
5	After completing zero-point calibration, close the equalizer valve. Open the stop valve and the drain plug of the low-pressure side to drain sealing liquid. Close the stop valve and the drain plug of the low-pressure side.

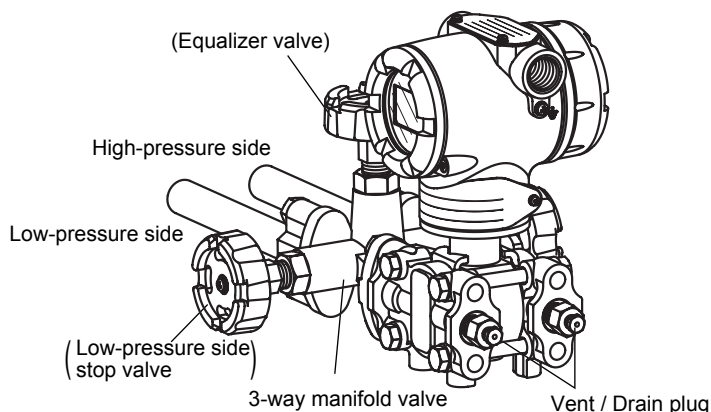

Introducing process pressure

Step	Description
1	Open the main valve (Refer to "Figure 2-17 Closed Tank - Piping (Wet-leg Sealing Example)".) to introduce process fluid into the connecting pipe.
2	Gradually open the low pressure side stop valve to introduce process fluid. After introducing process fluid into the pressure receiving part of the transmitter, close the low pressure side stop valve.
3	Make sure that the connecting pipe, the 3-way manifold valve, and the transmitter have no pressure leaks.

Starting Measurement

Procedure

Operate the valves by the following procedure to apply the differential pressure of the process to the transmitter and display the measured value by operating the HART® communicator.

How to apply process pressure

Step	Description
1	Make sure that the 3-way manifold valve is in this state: 1. High-pressure side stop valve: Fully closed 2. Low-pressure side stop valve: Fully closed 3. Equalizer valve: Fully closed
2	Fill the liquid sealing pipe with sealing liquid.
3	1. Gradually open the high-pressure side stop valve. 2. Gradually open the low-pressure side stop valve.

CAUTION

Close the cover of the transmitter case securely. Imperfect closure allows entry of water, damaging internal terminals and the electronics module.

- If the input and output values are inconsistent, check the range and perform calibration again.
- If the displayed data value is unstable, adjust the damping time constant.

Stopping Measurement

Procedure

How to stop the transmitter

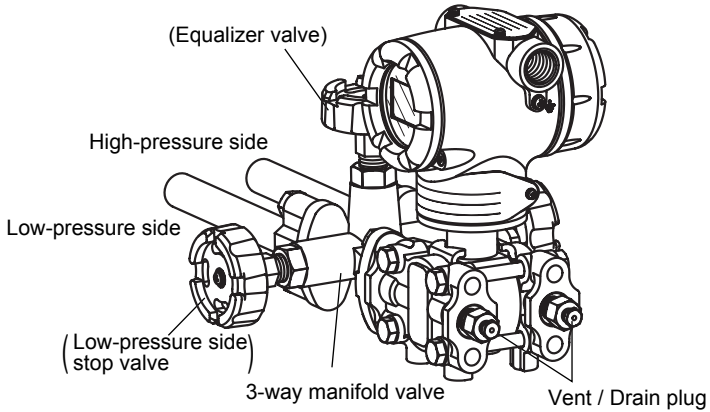
Step	Description
1	Turn off the transmitter.
2	<p>Operate the 3-way manifold valve by the following procedure:</p> <ol style="list-style-type: none"> 1. Close the low pressure side stop valve. 2. Open the equalizer valve. 3. Close the high pressure side stop valve. 
3	Close the main valve. (Refer to Figure 2-17.)

CAUTION

- If the transmitter is to be left off for a long period of time, drain process fluid from the connecting pipe and the pressure receiving part.
- Leave the equalizer valve open.

3.4 : Measurement with Model GTX__D/GTX__A

3.4.1 :Pressure Measurement

Preparation for Measurement

WARNING

-
- Make sure that the process is in the manual control mode.
If the process is in the automatic control mode, switch it to manual mode.
 - For hazardous fluids (poisons etc.) take any necessary actions to prevent physical hazard and ensure that work proceeds with adequate care.
 - Before starting a measurement procedure, ensure closure of the pressure valve (main valve), the local valve, the drain valve, and the gas vent plug (Refer to Figure 2-12).
-

Gas pressure measurement

Perform zero-point calibration and introduce process pressure, with this procedure:

CAUTION

If damping time constant is set to 0 sec., please adjust another value to keep output stable before calibration.

Zero-point calibration

Step	Description
1	Open the vent plug to release the pressure receiving part to the open air.
2	Referring to procedure2 in page 3-8, perform zero-point calibration.
3	When calibration is complete, close the vent plug.

Introducing process pressure and venting air

Step	Description
1	1. Introduce the process pressure into the connecting pipe by opening the main valve (Refer to "Figure 2-13 Example of Piping"). If the process temperature is high, allow cooling time so that the connecting pipe is stable at a safe temperature, before starting work. 2. Open the local valve gradually to introduce the process pressure into the pressure receiving part of transmitter.
2	1. Vent air from the center body by gradually opening the vent plug. 2. After venting air completely, close the plug and the local valve.
3	Ensure zero leakage exists at the connecting pipe and transmitter.

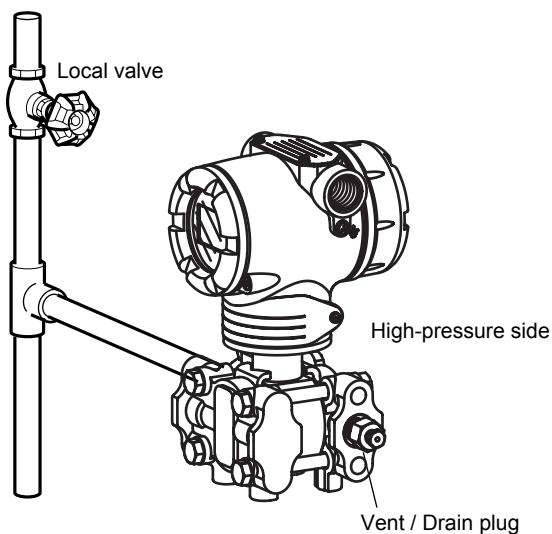

Starting Measurement

Procedure

Operate the valve with the following procedure and apply the process pressure to transmitter.

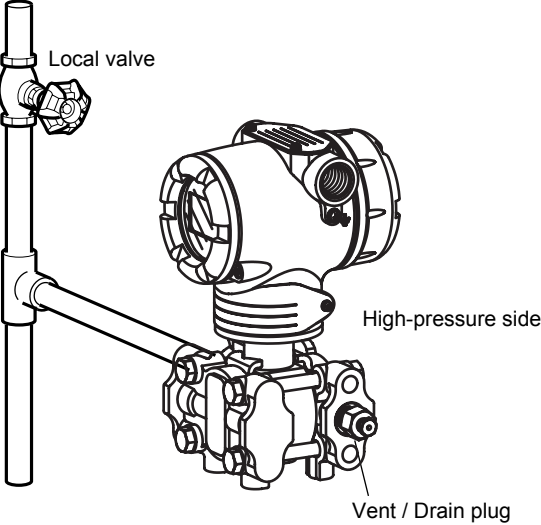
Step	Description
1	<p data-bbox="528 521 935 555">Open gradually the local valve.</p>  <p>The diagram illustrates the connection of a transmitter to a process line. A vertical pipe on the left has a 'Local valve' at the top. A horizontal pipe connects this valve to the 'High-pressure side' of the transmitter. The transmitter is shown with its case cover removed, revealing the internal components. A 'Vent / Drain plug' is located at the bottom of the transmitter body.</p>

CAUTION

Securely close the case cover of the transmitter. Take precautions against moisture ingress into the transmitter body. Water entering the transmitter will damage the internal terminals and the electronics module.

- If the output value does not correctly reflect the input value, check again the range and calibrate the transmitter.
- If the displayed data value is unstable, adjust the damping time constant

Stopping Measurement

Procedure

Stop the operation of the transmitter by this procedure:

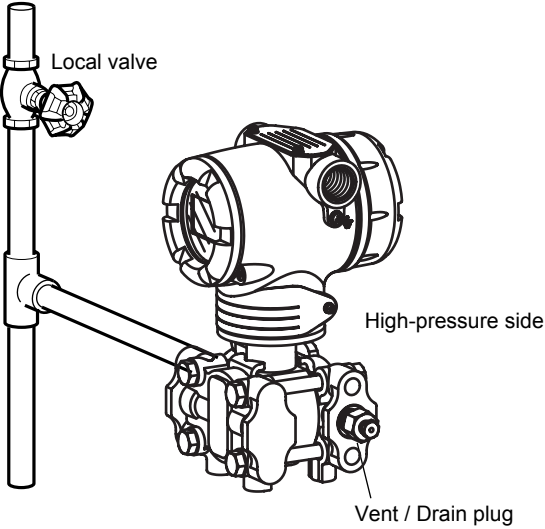
Step	Description
1	Turn OFF the transmitter.
2	Close the local valve. 
3	Close the main valve.

⚠ CAUTION

When a long-term shutdown is planned, completely drain all process fluid from the connecting pipe and from the pressure receiving part of transmitter.

3.5 : Measurement with Model GTX__F

3.5.1 :Pressure Measurement

Preparation for Measurement

When setting the zero point, set all the diaphragm surface area to be wet with the measured liquid for high accuracy. Even when the diaphragm surface area is not completely wet, make sure that the zero point is set at a level higher than the center of the diaphragm.

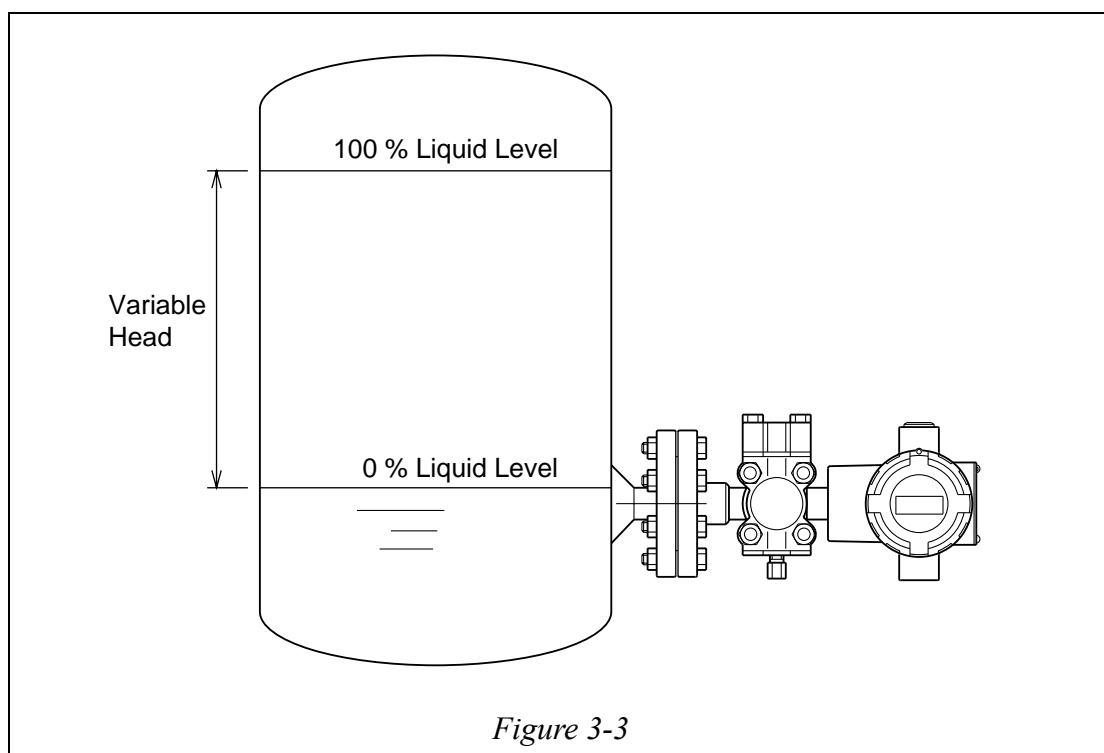

Starting Measurement

The transmitter is ready for operation when zero-point adjustment is completed. This procedure is described in the previous section. Before starting, always check the following:

- (1) Check the correspondence between input and output values.
 - If the output does not correctly reflect the input, check the range, check the flange position on the process, and calibrate the transmitter again.
- (2) Check the displayed data.
 - If unstable value is displayed, adjust the damping time constant.
- (3) Perform the following items carefully:
 - Disconnect the HART® communicator from the transmitter terminal. Ensure that the terminal is sufficiently tight, and not loose.
 - Close the case cover. Screw in the cover firmly until it can no longer be turned.
 - This transmitter has a locking structure. After closing the cover, tighten the lock using a hexagon wrench.

Stopping Measurement

Procedure

Turn off the transmitter.

CAUTION

When a long-term shutdown is planned, completely drain all process fluid from the connecting pipe and from the pressure receiving part of transmitter.

3.6 : Measurement with Model GTX__U/GTX__R

When starting operation, adjust the transmitter in its actual process state. The specific gravity of the sealed-in liquid is stated in the specifications in Appendix A. Specific gravity changes with temperature at the rate of $0.0008/^\circ\text{C}$. Use the temperature of the capillary tube for items related to specific gravity, in this section.

3.6.1 :Pressure Measurement

Preparation for Measurement

When setting the zero point, set all the diaphragm surface area to be wet with the measured liquid for high accuracy. Even when the diaphragm surface area is not completely wet, make sure that the zero point is set at a level higher than the center of the diaphragm.

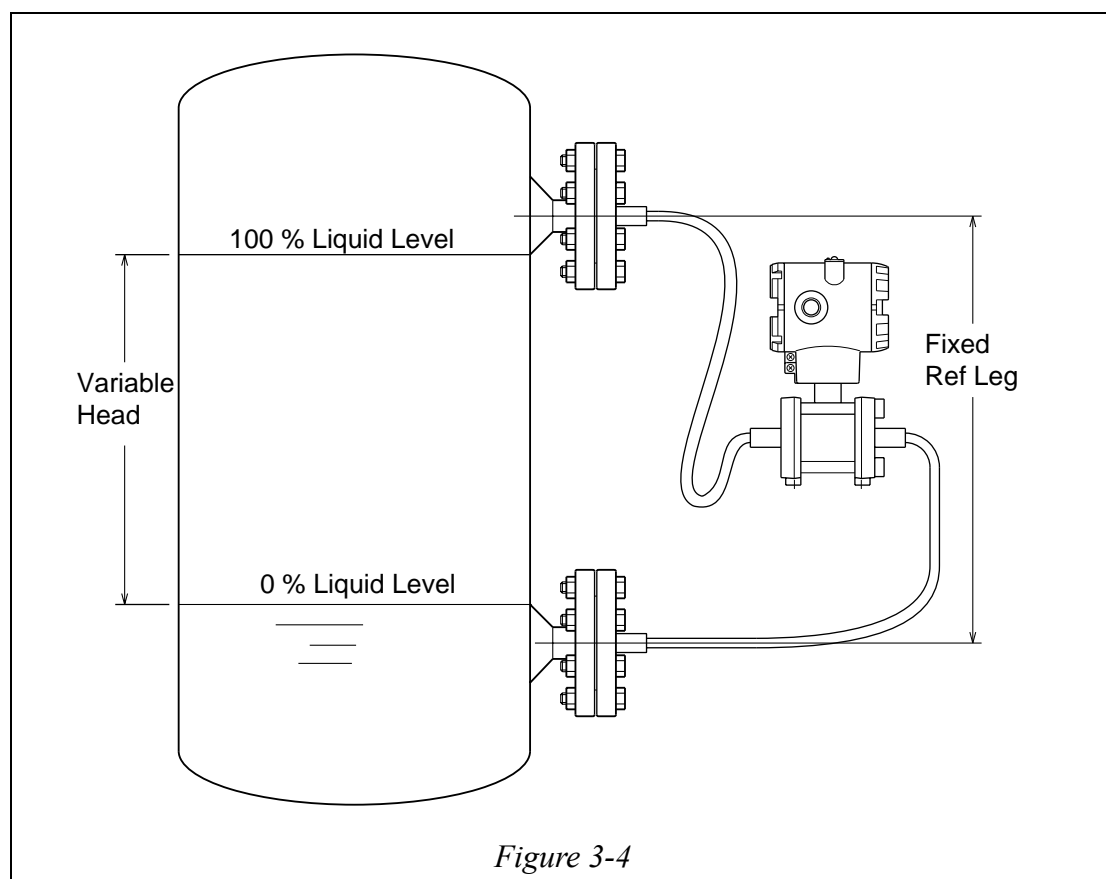

Starting Measurement

The transmitter is ready for operation when zero-point adjustment is completed. This procedure is described in the previous section. Before starting, always check the following:

- (1) Check the correspondence between input and output values.
 - If the output does not correctly reflect the input, check the range, check the flange position on the process, and calibrate the transmitter again.
- (2) Check the displayed data.
 - If unstable value is displayed, adjust the damping time constant.
- (3) Perform the following items carefully:
 - Disconnect the HART® communicator from the transmitter terminal. Ensure that the terminal is sufficiently tight, and not loose.
 - Close the case cover. Screw in the cover firmly until it can no longer be turned.
 - This transmitter has a locking structure. After closing the cover, tighten the lock using a hexagon wrench.

Stopping Measurement

Procedure

Turn OFF the transmitter.

CAUTION

When long-term shutdown is planned, always dismount the transmitter flange from the tank, clean diaphragms with a soft brush, wash using a solvent, and store. Take care not to deform or damage the diaphragms.

3.6.2 :Cautions Related to Flow Rate Measurement

Refer to the instructions on flange mounting for flow-rate measurement, to operate the transmitter for flow rate measurement.

Always complete zero-point checking before introducing fluid to the pipe. This precaution is warranted since the GTX__R/GTX__U has a structural characteristic that prevents mounting of an equalizing valve or stop valve.

For vertical pipes with differential-pressure take-out flange port, the high-pressure side flange and the low-pressure side flange exhibit a level difference. In this case, determine the zero point by setting LRV.

3.7 : Measurement with Model GTX__U

When starting operation, adjust the transmitter in its actual process state. The specific gravity of the sealed-in liquid is stated in the specifications of Chapter 3. Specific gravity changes with temperature at the rate of $0.0008/^\circ\text{C}$. Use the temperature of the capillary tube for items related to specific gravity, in this section.

3.7.1 : Pressure Measurement

Preparation for Measurement

When setting the zero point, set all the diaphragm surface area to be wet with the measured liquid for high accuracy. Even when the diaphragm surface area is not completely wet, make sure that the zero point is set at a level higher than the center of the diaphragm.

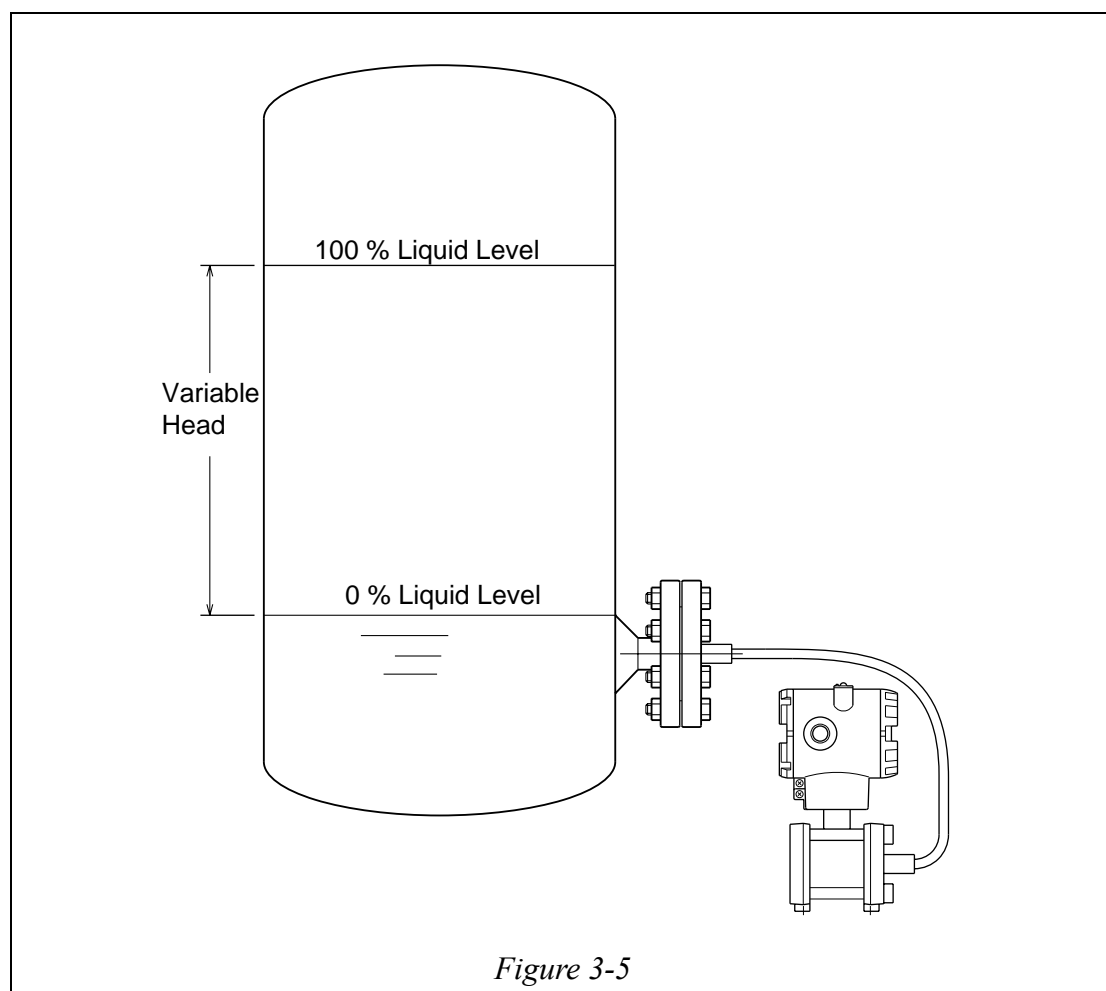

Starting Measurement

The transmitter is ready for operation when zero-point adjustment is completed. This procedure is described in the previous section. Before starting, always check the following:

- (1) Check the correspondence between input and output values.
 - If the output does not correctly reflect the input, check the range, check the flange position on the process, and calibrate the transmitter again.
- (2) Check the displayed data.
 - If unstable value is displayed, adjust the damping time constant.
- (3) Perform the following items carefully:
 - Disconnect the HART® communicator from the transmitter terminal. Ensure that the terminal is sufficiently tight, and not loose.
 - Close the case cover. Screw in the cover firmly until it can no longer be turned.
 - This transmitter has a locking structure. After closing the cover, tighten the lock using a hexagon wrench.

Stopping Measurement

Procedure

Turn OFF the transmitter.



CAUTION

When long-term shutdown is planned, always dismount the transmitter flange from the tank, clean diaphragms with a soft brush, wash using a solvent, and store. Take care not to deform or damage the diaphragms.

3.8 : Set Range Calculation for Liquid Level Measurement

3.8.1 : Open Tank or Closed Tank (Dry Leg) or Remote Seal Set Range Calculation

Set range calculation Ex. Model GTX__D

Calculate the set range using these procedures:

The following symbols are used to express density and distance.

It is assumed that the density is fixed, during liquid level measurement.

ρ : Specific gravity of liquid in tank

ρ_0 : Specific gravity of liquid in high pressure side connecting pipe

l : Distance between 100% liquid level and 0% liquid level (measurement range)

h : Distance between 0% liquid level and high-pressure outlet port

d : Distance between high-pressure outlet port and transmitter

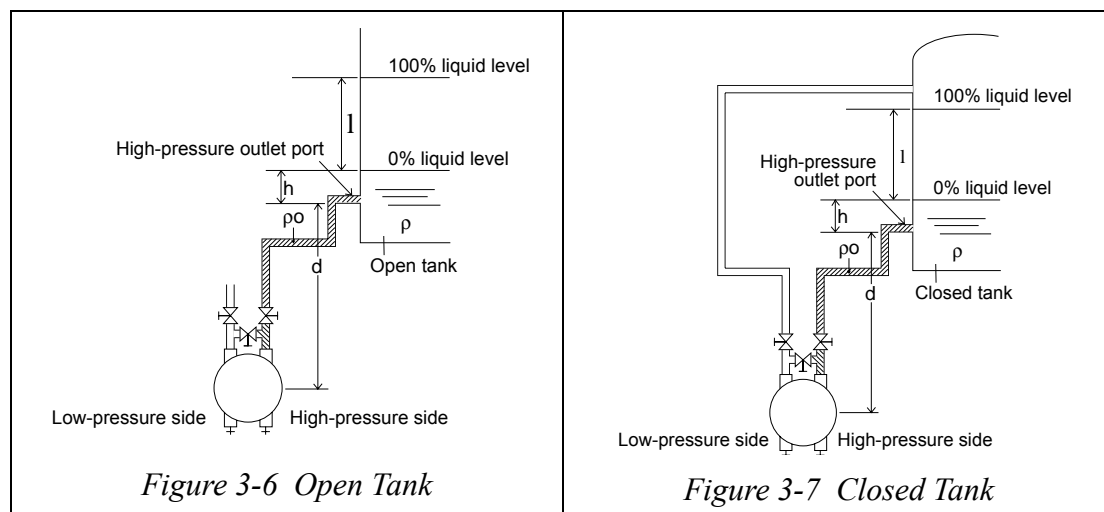

Differential pressure at 0% liquid level (Pressure on high-pressure side - Pressure on low-pressure side) = $h\rho + d\rho_0 = \text{LRV}$

Differential pressure at 100% liquid level (Pressure on high-pressure side - Pressure on low-pressure side) = $l\rho + h\rho + d\rho_0 = (l+h)\rho + d\rho_0 = \text{URV}$

Therefore, set the range as follows:

Low limit (LRV): $h\rho + d\rho_0$; High limit (URV): $(l+h)\rho + d\rho_0$

Example of calculation: $l = 1500 \text{ mm}$, $h = 250 \text{ mm}$, $d = 500 \text{ mm}$, $\rho = 0.9$, $\rho_0 = 1.0$

If the above conditions are assumed, the following results are obtained:

Differential pressure at 0% liquid level = $(250 \times 0.9) + (500 \times 1.0) = 725 \text{ mmH}_2\text{O} = 7.110 \text{ kPa}$

Differential pressure at 100% liquid level = $\{(1500 + 250) \times 0.9\} + (500 \times 1.0) = 2075 \text{ mmH}_2\text{O} = 20.35 \text{ kPa}$

Therefore, set the range as follows:

Low limit (LRV): $7.110 \text{ kPa}\{725 \text{ mmH}_2\text{O}\}$, High limit (URV): $20.35 \text{ kPa}\{2075 \text{ mmH}_2\text{O}\}$

Set range calculation Ex. Model GTX__G

Calculate the set range using these procedures:

The following symbols are used to express density and distance.

It is assumed that the density is fixed, during liquid level measurement.

- ρ : Specific gravity of liquid in tank
- ρ_0 : Specific gravity of liquid in connecting pipe
- l : Distance between 100% liquid level and 0% liquid level (measurement range)
- h : Distance between 0% liquid level and high-pressure outlet port
- d : Distance between high-pressure outlet port and transmitter

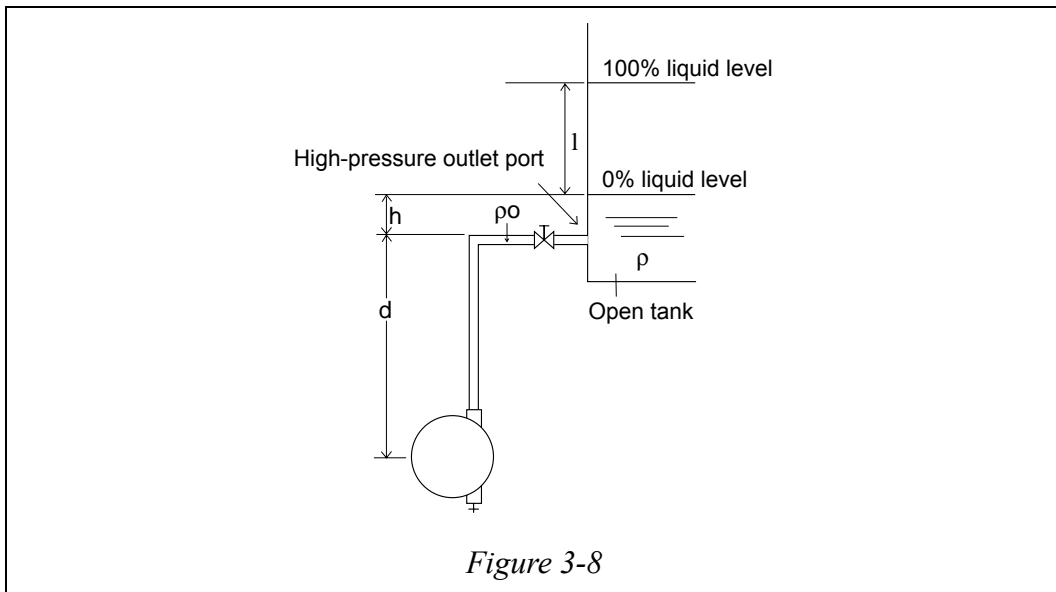

Pressure at 0% liquid level = $h\rho + d\rho_0 = \text{LRV}$

Pressure at 100% liquid level = $l\rho + h\rho + d\rho_0 = (l+h)\rho + d\rho_0 = \text{URV}$

Therefore, set the range as follows:

Low limit (LRV): $h\rho + d\rho_0$; High limit (URV): $(l+h)\rho + d\rho_0$

Example of calculation:

$l = 1500 \text{ mm}, h = 250 \text{ mm}, d = 500 \text{ mm}$

$\rho = 0.9, \rho_0 = 1.0$

If the above conditions are assumed, the following results are obtained:

Differential pressure at 0% liquid level = $(250 \times 0.9) + (500 \times 1.0) = 725 \text{ mmH}_2\text{O} = 7.110 \text{ kPa}$

Differential pressure at 100% liquid level = $\{(1500 + 250) \times 0.9\} + (500 \times 1.0) = 2075 \text{ mmH}_2\text{O} = 20.35 \text{ kPa}$

Therefore, set the range as follows:

Low limit (LRV): $7.110 \text{ kPa}\{725 \text{ mmH}_2\text{O}\}$, High limit (URV): $20.35 \text{ kPa}\{2075 \text{ mmH}_2\text{O}\}$

Set range calculation Ex. Model GTX__F

Calculate the set range using these procedures:

The following symbols are used to express density and distance.

It is assumed that the density is fixed, during liquid level measurement.

- ρ : Specific gravity of liquid in tank
- l : Distance between 100% liquid level and 0% liquid level (measurement range)
- h : Distance between 0% liquid level and high-pressure outlet port
- d : Distance between high-pressure outlet port and transmitter

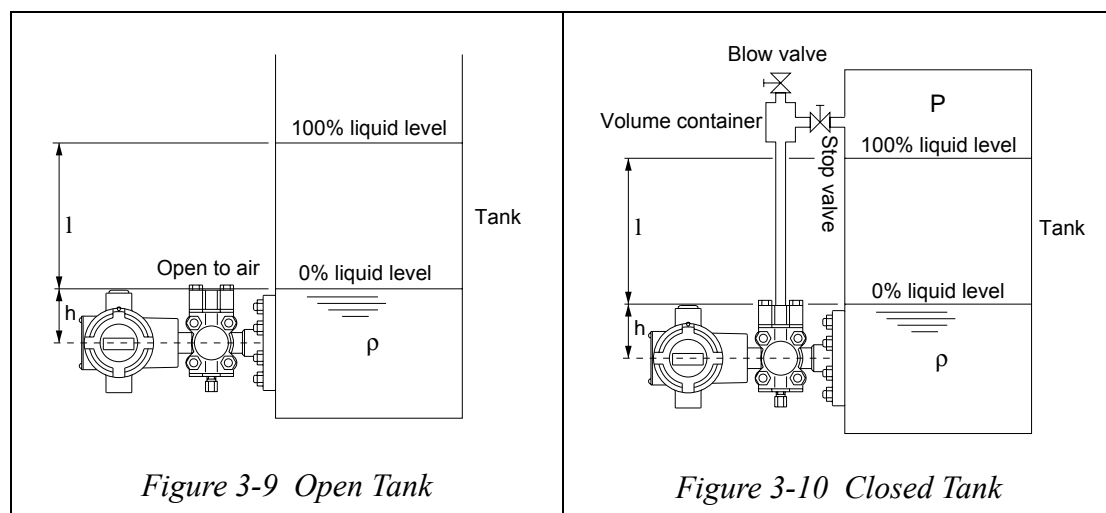

Differential pressure at 0% liquid level (Pressure on high-pressure side - Pressure on low-pressure side) = $h\rho = \text{LRV}$

Differential pressure at 100% liquid level (Pressure on high-pressure side - Pressure on low-pressure side) = $l\rho + h\rho = (l+h)\rho = \text{URV}$

Therefore, set the range as follows:

Low limit (LRV): $h\rho$; High limit (URV): $(l+h)\rho$

Example of calculation:

$$l = 1500 \text{ mm}, h = 250 \text{ mm}$$

$$\rho = 0.9, \rho_0 = 1.0$$

If the above conditions are assumed, the following results are obtained:

$$\text{Differential pressure at 0\% liquid level} = (250 \times 0.9) = 725 \text{ mmH}_2\text{O} = 7.110 \text{ kPa}$$

$$\text{Differential pressure at 100\% liquid level} = \{(1500 + 250) \times 0.9\} = 2075 \text{ mmH}_2\text{O} = 20.35 \text{ kPa}$$

Therefore, set the range as follows:

Low limit (LRV): 7.110 kPa {725 mmH₂O}, High limit (URV): 20.35 kPa {2075 mmH₂O}

Set range calculation Ex. Model GTX__R

Calculate the set range using these procedures:

The following symbols are used to express density and distance.

It is assumed that the density is fixed, during liquid level measurement.

ρ : Specific gravity of liquid in tank

ρ_0 : Specific gravity of sealed liquid

l : Distance between 100% liquid level and 0% liquid level (measurement range)

h : Distance between 0% liquid level and high-pressure outlet port

d : Distance between high-pressure outlet port and transmitter

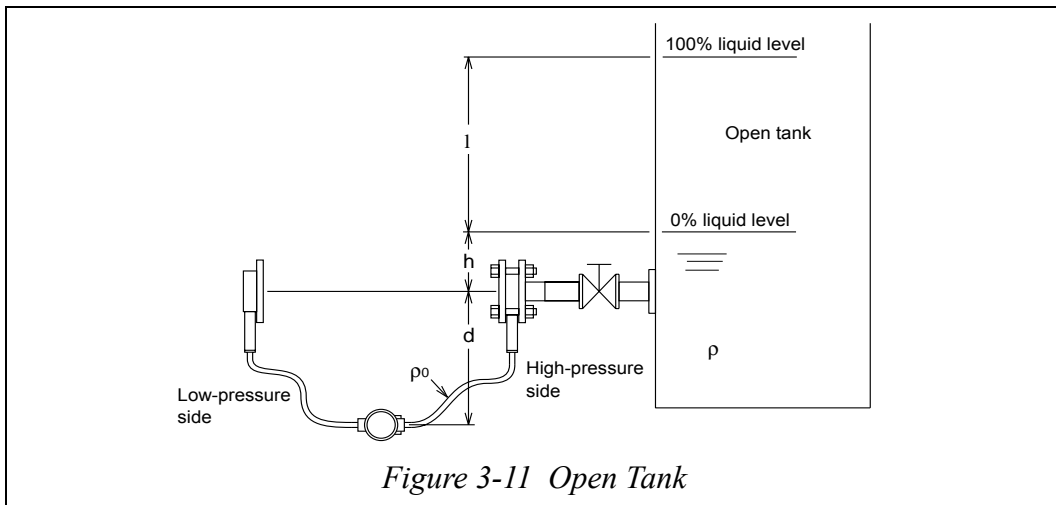

Figure 3-11 Open Tank

Differential pressure at 0% liquid level (Pressure on high-pressure side - Pressure on low-pressure side) = $hr = \text{LRV}$

Differential pressure at 100% liquid level (Pressure on high-pressure side - Pressure on low-pressure side) = $l\rho + h\rho = (l+h)\rho = \text{URV}$

Therefore, set the range as follows:

Low limit (LRV): $h\rho$; High limit (URV): $(l+h)\rho$

Example of calculation:

$l = 1500 \text{ mm}$, $h = 250 \text{ mm}$, $d = 500 \text{ mm}$, $\rho = 0.9$, $\rho_0 = 0.935$

If the above conditions are assumed, the following results are obtained:

Differential pressure at 0% liquid level = $250 \times 0.9 = 225 \text{ mmH}_2\text{O} = 2.206 \text{ kPa}$

Differential pressure at 100% liquid level = $(1500 + 250) \times 0.9 = 1575 \text{ mmH}_2\text{O} = 15.45 \text{ kPa}$

Therefore, set the range as follows:

Low limit (LRV): 2.206 kPa, High limit (URV): 15.45 kPa

Set range calculation Ex. Model GTX__U

Calculate the set range using these procedures:

The following symbols are used to express density and distance.

It is assumed that the density is fixed, during liquid level measurement.

ρ : Specific gravity of liquid in tank

ρ_0 : Specific gravity of sealed liquid

l : Distance between 100% liquid level and 0% liquid level (measurement range)

h : Distance between 0% liquid level and high-pressure outlet port

d : Distance between high-pressure outlet port and transmitter

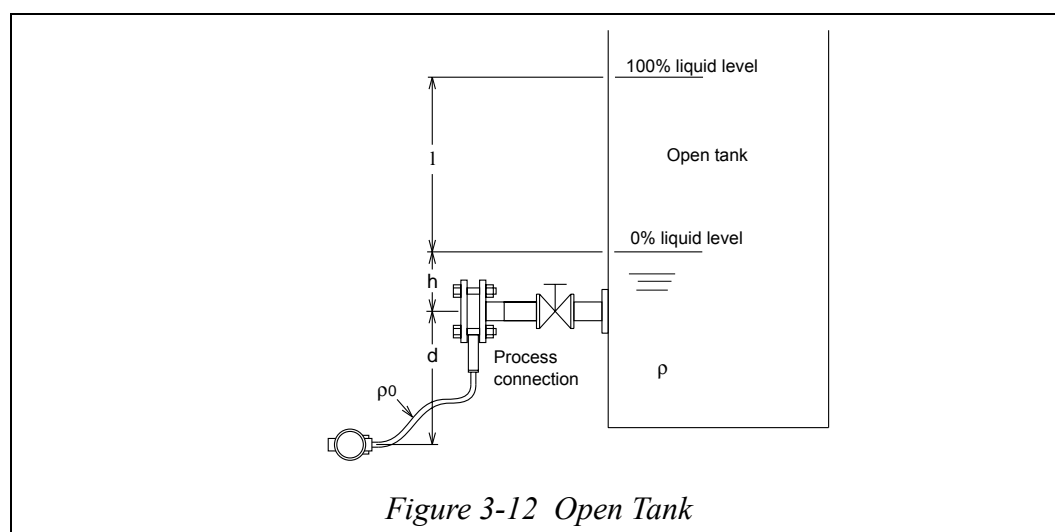

Differential pressure at 0% liquid level = $h\rho + d\rho_0 = \text{LRV}$

Differential pressure at 100% liquid level = $l\rho + h\rho + d\rho_0 = (l+h)\rho + d\rho_0 = \text{URV}$

Therefore, set the range as follows:

Low limit (LRV): $h\rho + d\rho_0$; High limit (URV): $(l+h)\rho + d\rho_0$

Example of calculation:

$l = 1500 \text{ mm}$, $h = 250 \text{ mm}$, $d = 500 \text{ mm}$, $\rho = 0.9$, $\rho_0 = 1.0$

If the above conditions are assumed, the following results are obtained:

Differential pressure at 0% liquid level = $(250 \times 0.9) + (500 \times 1.0) = 725 \text{ mmH}_2\text{O} = 7.110 \text{ kPa}$

Differential pressure at 100% liquid level = $\{(1500 + 250) \times 0.9\} + (500 \times 1.0) = 2075 \text{ mmH}_2\text{O} = 20.35 \text{ kPa}$

Therefore, set the range as follows:

Low limit (LRV): 7.110 kPa, High limit (URV): 20.35 kPa

3.8.2 :Closed Tank (Wet Leg or Remote Seal) -- Set Range

Set range calculation Ex. Model GTX__D

Calculate the set range using these procedure:

The following symbols are used to express density and distance.

It is assumed that the density is fixed during liquid level measurement.

ρ : Specific gravity of liquid in tank

ρ_0 : Specific gravity of sealing liquid

l : Distance between 100% liquid level and 0% liquid level (measurement range)

h : Distance between 0% liquid level and high-pressure outlet port

d : Distance between high-pressure outlet port and transmitter

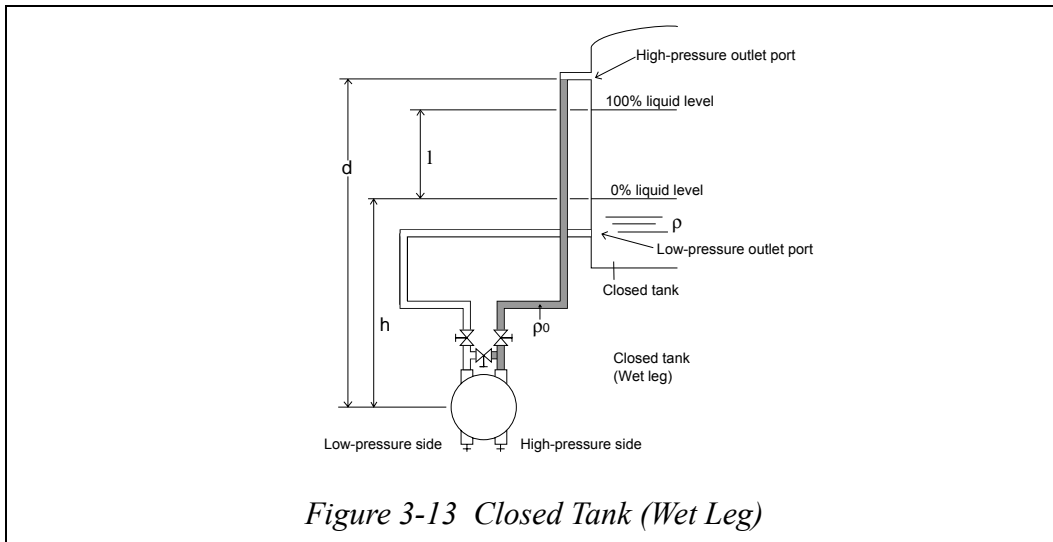

Differential pressure at 0% liquid level (Pressure on high-pressure side - Pressure on low-pressure side) = $d\rho_0 - h\rho = \text{LRV}$

Differential pressure at 100% liquid level (Pressure on high-pressure side - Pressure on low-pressure side) = $d\rho_0 - (l+h)\rho = \text{URV}$

Therefore, set the range as follows:

Low limit (LRV): $d\rho_0 - h\rho$, High limit (URV): $d\rho_0 - (l+h)\rho$

Example of calculation:

$$l = 1500 \text{ mm}, h = 250 \text{ mm}, d = 2000 \text{ mm}, \rho = 0.9, \rho_0 = 1.0$$

If the above conditions are assumed, the following results are obtained:

$$\text{Differential pressure at 0\% liquid level} = (2000 \times 1.0) + (250 \times 0.9) = 1775 \text{ mmH}_2\text{O} = 17.41 \text{ kPa}$$

$$\text{Differential pressure at 100\% liquid level} = (2000 \times 1.0) + (1500 + 250) \times 0.9 = 425 \text{ mmH}_2\text{O} = 4.168 \text{ kPa}$$

Therefore, set the range as follows:

Low limit (LRV): 17.41 kPa {1775 mmH₂O}, High limit (URV): 4.168 kPa {425 mmH₂O}

Set range calculation Ex. Model GTX__F

Calculate the set range using these procedure:

The following symbols are used to express density and distance.

It is assumed that the density is fixed during liquid level measurement.

ρ : Specific gravity of liquid in tank

ρ_0 : Specific gravity of sealing liquid

l : Distance between 100% liquid level and 0% liquid level (measurement range)

h : Distance between 0% liquid level and high-pressure outlet port

d : Distance between high-pressure outlet port and transmitter

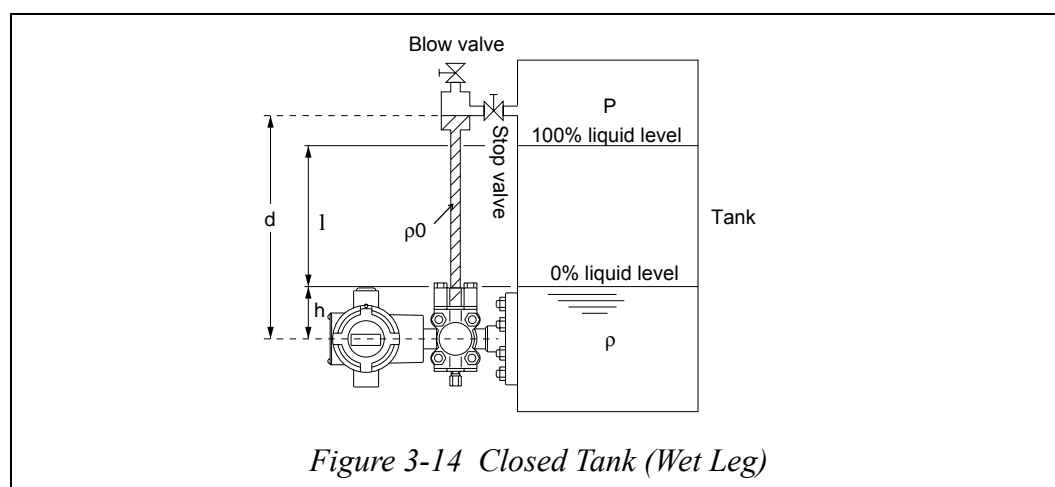

Differential pressure at 0% liquid level (Pressure on high-pressure side - Pressure on low-pressure side) = $d\rho_0 - h\rho = \text{LRV}$

Differential pressure at 100% liquid level (Pressure on high-pressure side - Pressure on low-pressure side) = $d\rho_0 - (l+h)\rho = \text{URV}$

Therefore, set the range as follows:

Low limit (LRV): $d\rho_0 - h\rho$, High limit (URV): $d\rho_0 - (l+h)\rho$

Example of calculation:

$l = 1500 \text{ mm}$, $h = 250 \text{ mm}$, $d = 2000 \text{ mm}$, $\rho = 0.9$, $\rho_0 = 1.0$

If the above conditions are assumed, the following results are obtained:

Differential pressure at 0% liquid level = $(2000 \times 1.0) + (250 \times 0.9) = 1775 \text{ mmH}_2\text{O} = 17.41 \text{ kPa}$

Differential pressure at 100% liquid level = $(2000 \times 1.0) + (1500 \times 250) \times 0.9 = 425 \text{ mmH}_2\text{O} = 4.168 \text{ kPa}$

Therefore, set the range as follows:

Low limit (LRV): $17.41 \text{ kPa} \{1775 \text{ mmH}_2\text{O}\}$, High limit (URV): $4.168 \text{ kPa} \{425 \text{ mmH}_2\text{O}\}$

Set range calculation Ex. Model GTX__R

Calculate the set range using these procedure:

The following symbols are used to express density and distance.

It is assumed that the density is fixed during liquid level measurement.

ρ : Specific gravity of liquid in tank

ρ_0 : Specific gravity of sealed liquid

l : Distance between 100% liquid level and 0% liquid level (measurement range)

h : Distance between 0% liquid level and lower flange of tank

d : Distance between upper flange of tank and lower flange of tank

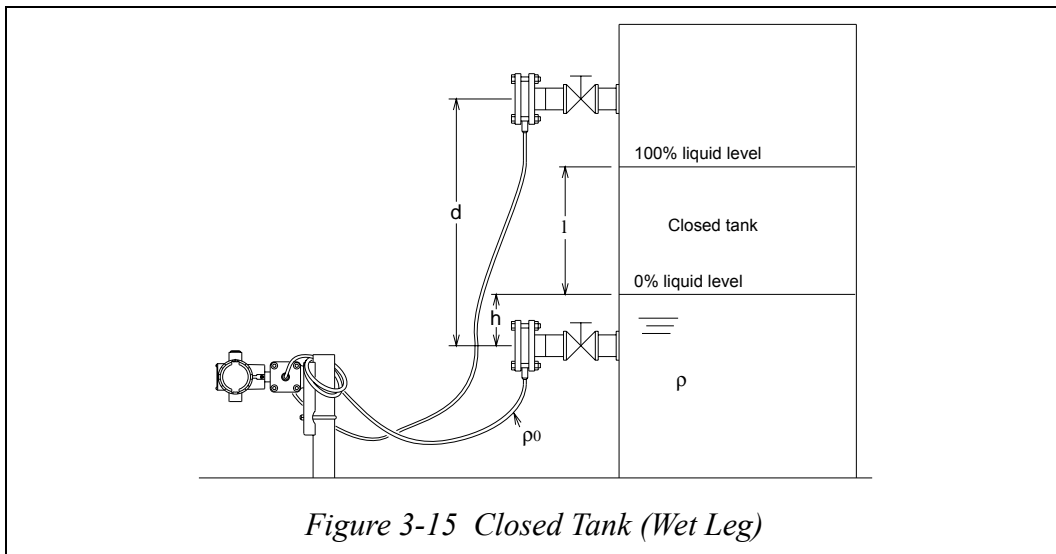

Differential pressure at 0% liquid level (Pressure on high-pressure side - Pressure on low-pressure side) = $d\rho_0 - h\rho = \text{LRV}$

Differential pressure at 100% liquid level (Pressure on high-pressure side - Pressure on low-pressure side) = $d\rho_0 - (l+h)\rho = \text{URV}$

Therefore, set the range as follows:

Low limit (LRV): $d\rho_0 - h\rho$, High limit (URV): $d\rho_0 - (l+h)\rho$

Example of calculation:

$l = 1500 \text{ mm}$, $h = 250 \text{ mm}$, $d = 2000 \text{ mm}$, $\rho = 0.9$, $\rho_0 = 0.935$

If the above conditions are assumed, the following results are obtained:

Differential pressure at 0% liquid level = $(2000 \times 0.935) - (250 \times 0.9) = 1645 \text{ mmH}_2\text{O}$
 = 16.13 kPa

Differential pressure at 100% liquid level = $(2000 \times 0.935) + (1500 \times 250) \times 0.9 = 295 \text{ mmH}_2\text{O}$
 = 2.893 kPa

Therefore, set the range as follows:

Low limit (LRV): 16.13 kPa {1645 mmH₂O}, High limit (URV): 2.893 kPa {295 mmH₂O}

3.9 : Indicator (Optional)

3.9.1 :Display unit of indicator

The display unit of an indicator consists of the following:

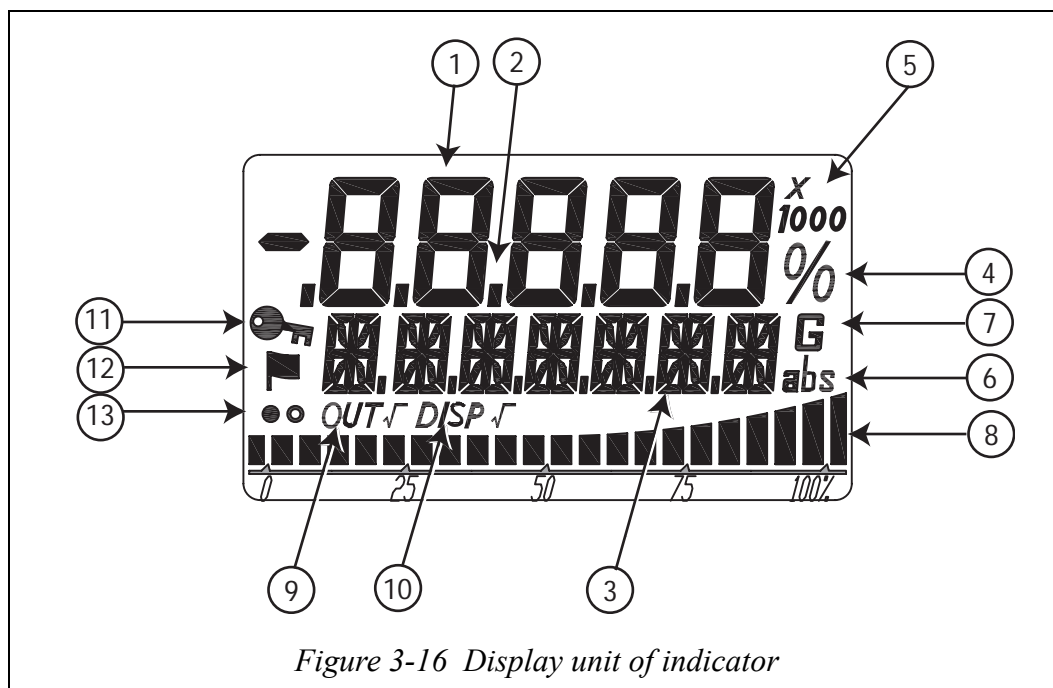

Figure 3-16 Display unit of indicator

No.	Display Mark	Contents of display
1	Digital Display (5digits)	PV (% , actual, pressure) Status Number
2	Digital Display (5digits)	Decimal point
3	16 segments (7digit)	Unit, Status
4	%	%
5	Exponent	None, ×10, ×100, ×1000
6	Absolute pressure	Abs
7	Gage pressure	G
8	Bar Graph	Bar Graph of output%
9	Output square root extraction	OUT √
10	Display square root extraction	DISP √
11	Key mark	Write Protect
12	Flag mark	Status Record
13	Status Record	● and ○

3.9.2 :Bar Graph Display

Percentage terms of the indicated values are displayed as graphs with the 22 segments.



For descriptive purposes let us refer to the 22 segments as, from left to right, S0 - S21. Lighting or blinking of each segment is indicated as follows according to the percentage terms of the indicated value (DISP).

DISP ≤ -5%	S0 Blinking	⏏
-5% < DISP ≤ 0%	S0 Lit	■
0% < DISP ≤ 5%	S0 to S1 Lit	■■
5% < DISP ≤ 10%	S0 to S2 Lit	■■■
10% < DISP ≤ 15%	S0 to S3 Lit	■■■■
15% < DISP ≤ 20%	S0 to S4 Lit	■■■■■
20% < DISP ≤ 25%	S0 to S5 Lit	■■■■■■
25% < DISP ≤ 30%	S0 to S6 Lit	■■■■■■■
30% < DISP ≤ 35%	S0 to S7 Lit	■■■■■■■■
35% < DISP ≤ 40%	S0 to S8 Lit	■■■■■■■■■
40% < DISP ≤ 45%	S0 to S9 Lit	■■■■■■■■■■
45% < DISP ≤ 50%	S0 to S10 Lit	■■■■■■■■■■■
50% < DISP ≤ 55%	S0 to S11 Lit	■■■■■■■■■■■■
55% < DISP ≤ 60%	S0 to S12 Lit	■■■■■■■■■■■■■
60% < DISP ≤ 65%	S0 to S13 Lit	■■■■■■■■■■■■■■
65% < DISP ≤ 70%	S0 to S14 Lit	■■■■■■■■■■■■■■■
70% < DISP ≤ 75%	S0 to S15 Lit	■■■■■■■■■■■■■■■■
75% < DISP ≤ 80%	S0 to S16 Lit	■■■■■■■■■■■■■■■■■
80% < DISP ≤ 85%	S0 to S17 Lit	■■■■■■■■■■■■■■■■■■
85% < DISP ≤ 90%	S0 to S18 Lit	■■■■■■■■■■■■■■■■■■■
90% < DISP ≤ 95%	S0 to S19 Lit	■■■■■■■■■■■■■■■■■■■■
95% < DISP ≤ 100%	S0 to S20 Lit	■■■■■■■■■■■■■■■■■■■■■
100% < DISP ≤ 105%	S0 to S21 Lit	■■■■■■■■■■■■■■■■■■■■■■
105% < DISP	S0 to S20 Lit, S21Blinking	■■■■■■■■■■■■■■■■■■■■■■⏏

3.9.3 :External Zero/Span Adjustment Display

When an external zero or span adjustment is executed using an external zero/span adjustment mechanism and the range change is complete, one of the following messages is displayed in the 16 segments (7 digits) that display the unit, depending on the adjustment.

When an external zero adjustment is complete: ZERO.SET

When an external span adjustment is complete: SPAN.SET

The message is displayed for 3 seconds and then it disappears to return to the unit display.

3.9.4 :Square Root Extraction Display

The segments for the square root extraction display are OUT $\sqrt{\quad}$ and DISP $\sqrt{\quad}$.

Each display lights up or goes out according to the output format and square root extraction display settings of the transmitter.

Transmitter setting		Square Root Extraction Display	
Output	Indicator	OUT $\sqrt{\quad}$	DISP $\sqrt{\quad}$
Linear	Linear	Goes out	Goes out
Linear	Square root (Flow rate)	Goes out	Lights up
Square root (Flow rate)		Lights up	Goes out

3.9.5 :Write Protect Display

The indicator for the write protect display is a key mark.

The key mark lights up or goes out according to the write protect state of the transmitter.

When write protect is ON: The key mark lights up.

When write protect is OFF: The key mark goes out.

3.9.6 :Status Record Display

The indicator for the status history display is a flag mark.

The flag mark lights up or goes out according to the presence or absence of status history of the transmitter.

When the status history exists: The flag mark lights up.

When the status history does not exist: The flag mark goes out.

Lighting of the flag mark indicates that the diagnostic status has been ON in the past.

3.9.7 :Display Update Mark

This mark indicates that the transmitter is working.

The ● and ○ marks alternately blink every 0.5 seconds.

Display Update Cycle

The update cycle of the PV display (7 segments, 5 digits) is about 0.5 seconds.

3.10 : External Zero/Span Adjustment function (Optional)

A transmitter with External Zero/Span adjustment function enables zero/span point adjustment work without using communicator.

Set output to any value corresponding to the pressure input.

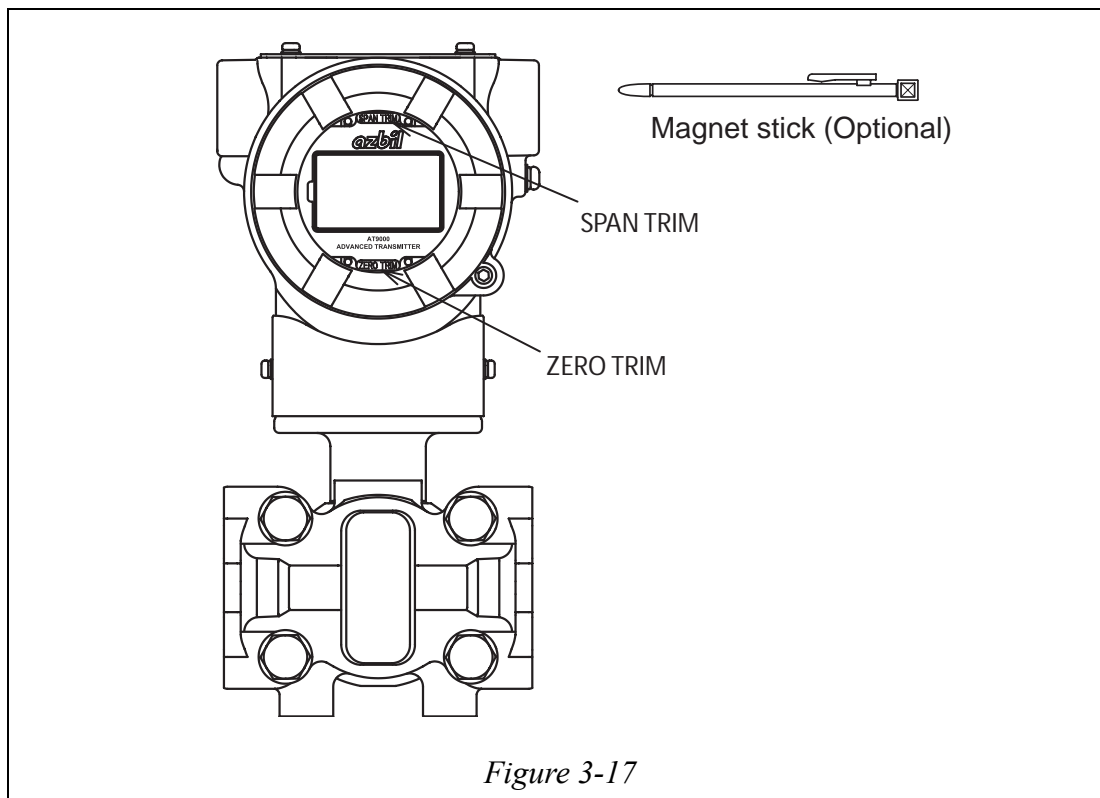

Figure 3-17

Procedure

How to adjust zero point.:

STEP	Procedure
1	Make sure that the zero pressure is applied to the transmitter.
2	Touch the magnet on the grass at the ZERO TRIM point for 3 seconds or more. And remove it when ammeter reading equals 4mA.

How to adjust span point.:

STEP	Procedure
1	Make sure that the desired upper range value pressure is applied to the transmitter.
2	Touch the magnet on the grass at the SPAN TRIM point for 3 seconds or more. And remove it when ammeter reading equals 20mA.

Chapter 4 : Operation Using HART® Communicator

4.1 : Starting Communications

Instructions for connecting HART® Communicator to this transmitter.
Basic instructions for Key-pad operation.

4.1.1 :Connecting communicator

You connect the communicator directly to signal terminals on the transmitter's terminal block or at any location in the 4 to 20 mA loop. (Polarity of the communicator connection does not matter)

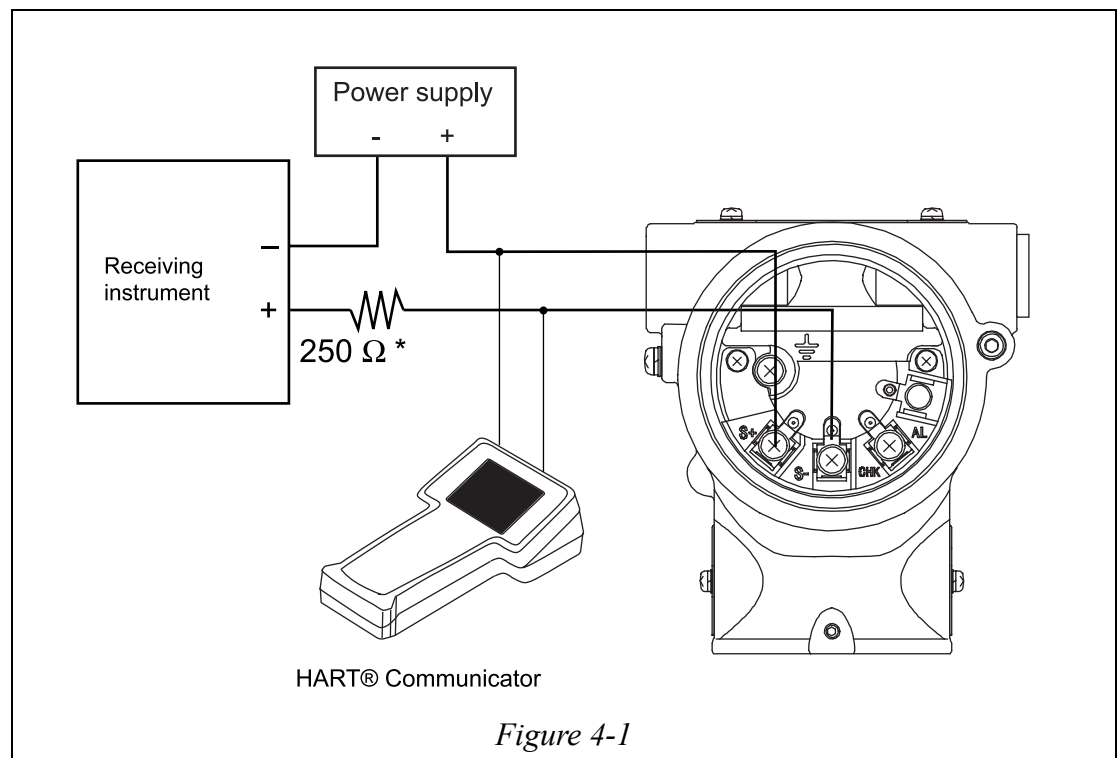

4.1.2 :HART® 375 FIELD COMMUNICATOR keyboard



4.1.3 :Symbols on communicator screen

See manual of 375 FIELD COMMUNICATOR.

4.1.4 :Keying in alphanumeric characters

See manual of 375 FIELD COMMUNICATOR.

4.1.5 :Establishing communications

This procedure starts communications between the transmitter and the communicator:

STEP	Action and/or Description
1	Turn on communicator. The communicator runs a self-test check then determines if it is connected to a transmitter.
2	<p>If you receive a communication error message (No Device Found), check the following:</p> <ul style="list-style-type: none"> • Loop resistance: Is there a minimum of 250 Ω resistance between the communicator and the power supply? • Power supply: Is power applied? Is there greater than 11 volts at the transmitter? <p>Correct any problems, and try communicating again. If the message, or any other error message, appears again.</p>
3	<p>When the “Online” display - shown below - appears, you have established communication with the transmitter.</p> <p>The flashing heart icon in the upper right corner indicates the communicator and the transmitter are communicating.</p>

4.1.6 :Checking basic data

This procedure checks the transmitter's factory-set configuration parameters:

STEP	Action and/or Description
1	From the “Online” menu, enter “Device setup” by pressing the right arrow (→) key on the communicator keypad.
2	Press the down arrow (↓) key to scroll down to menu-item “5 Review”.

STEP	Action and/or Description
3	Press PREV and/or NEXT to scroll through the configuration data including: <ul style="list-style-type: none"> • Model • Measurement Type • Transfer Function • Cutoff Mode • Height • PROM No. • Software Rev • Damping • Lower Range Value (0%) • Upper Range Value (100%) • Upper Range Limit • Fail Safe Direction • Display Mode • Disp. Unit • User Unit • EULO (0%) • EUHI (100%) • Exponent • Output Low Limit • Output High Limit • Output Alarm • Lower Output Alarm • Upper Output Alarm • Sensor Temp. Alarm • Lower Sensor Temp. Alarm • Upper Sensor Temp. Alarm • Contact Output ON/OFF • Alarm Status • Contact Output Mode • Contact Output Status • Output • Pressure • Sensor Temp.
4	Press left arrow to go back to the “Device” menu
5	Tap the  icon in the upper right corner of the touch screen to finish the communication. “HART Application” is finished and back to “375 Main Menu.”

4.2 : Configuration

This section introduces you configuration of AT9000 with HART® option using the HART® Communicator.

This section also provides an overview of the HART® Communicator, including menus and keyboards.

4.3 : Top menu

The “Top menu” consists of 3 items.

1. Process Variables
2. Device
3. Diagnostic

4.4 : Process Variables menu summary

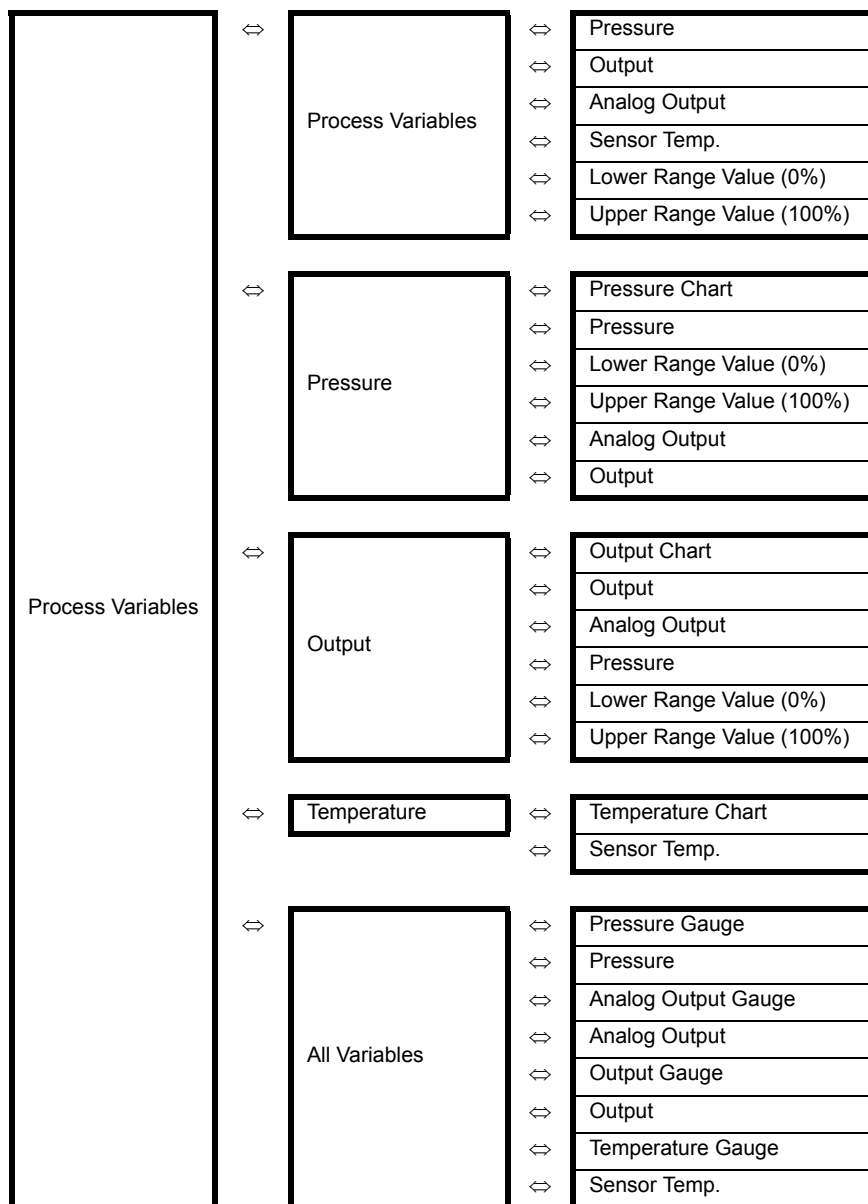

4.5 : Device menu summary

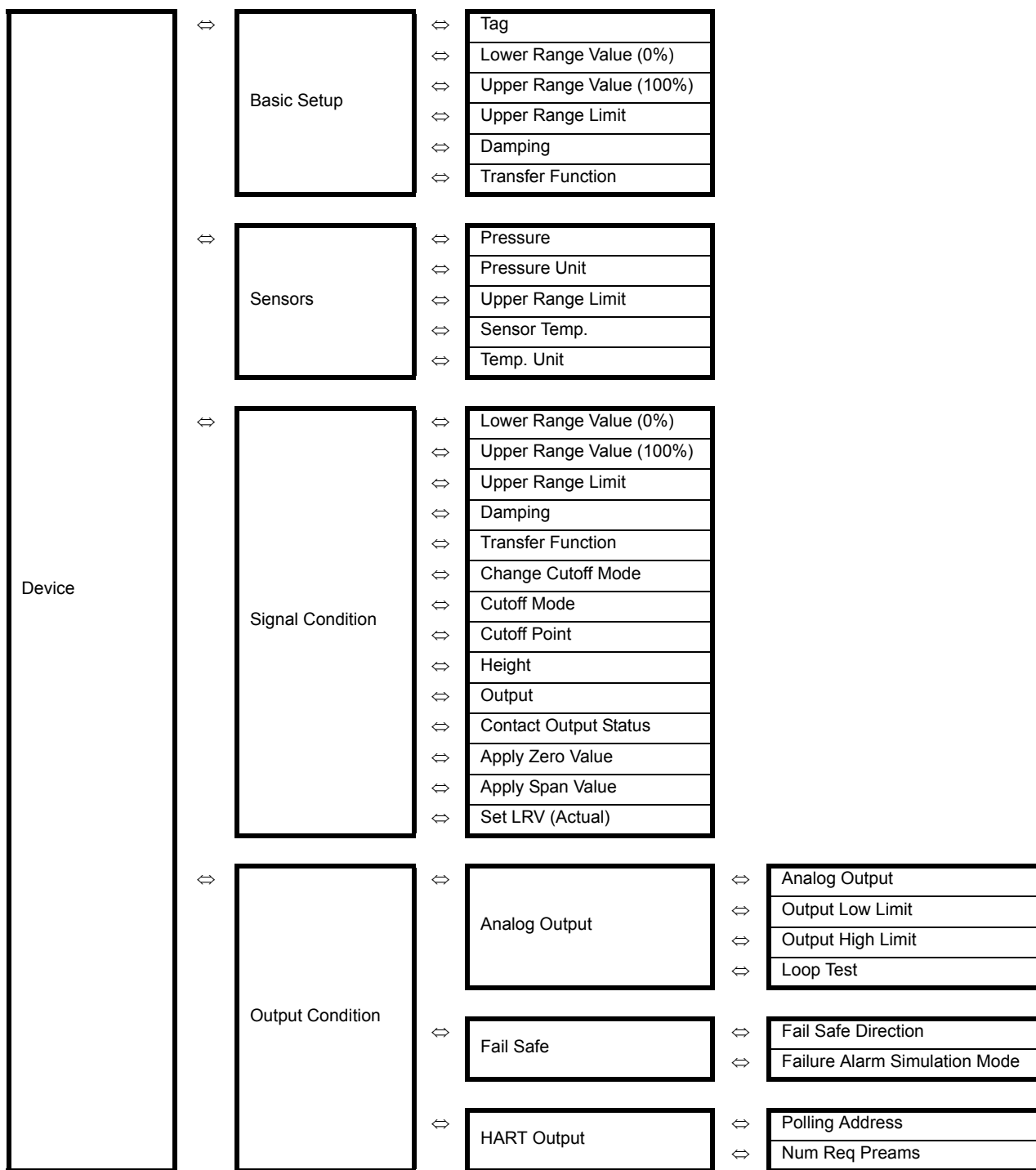

(Continued)

(Continued from previous page)

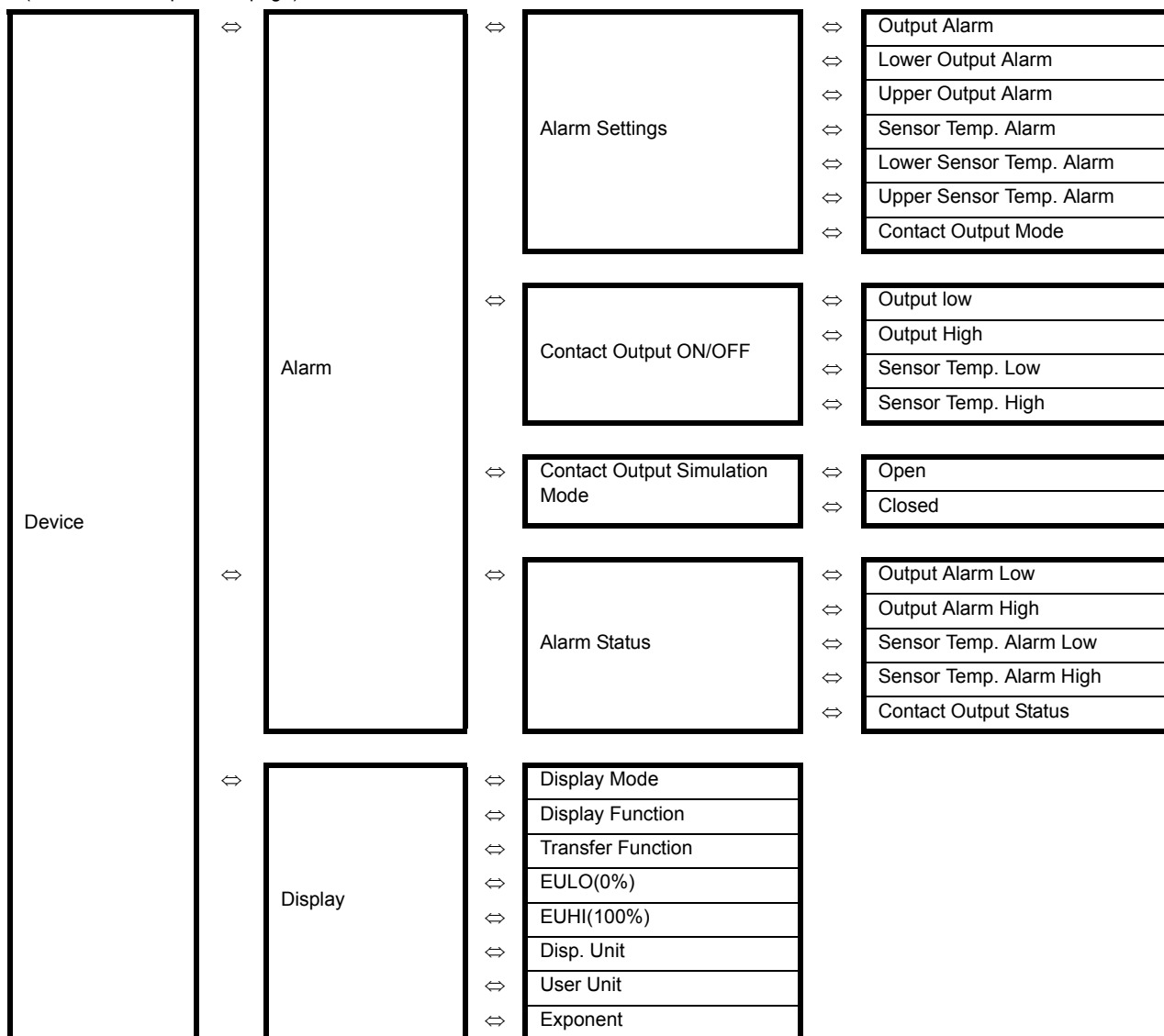

(Continued)

(Continued from previous page)

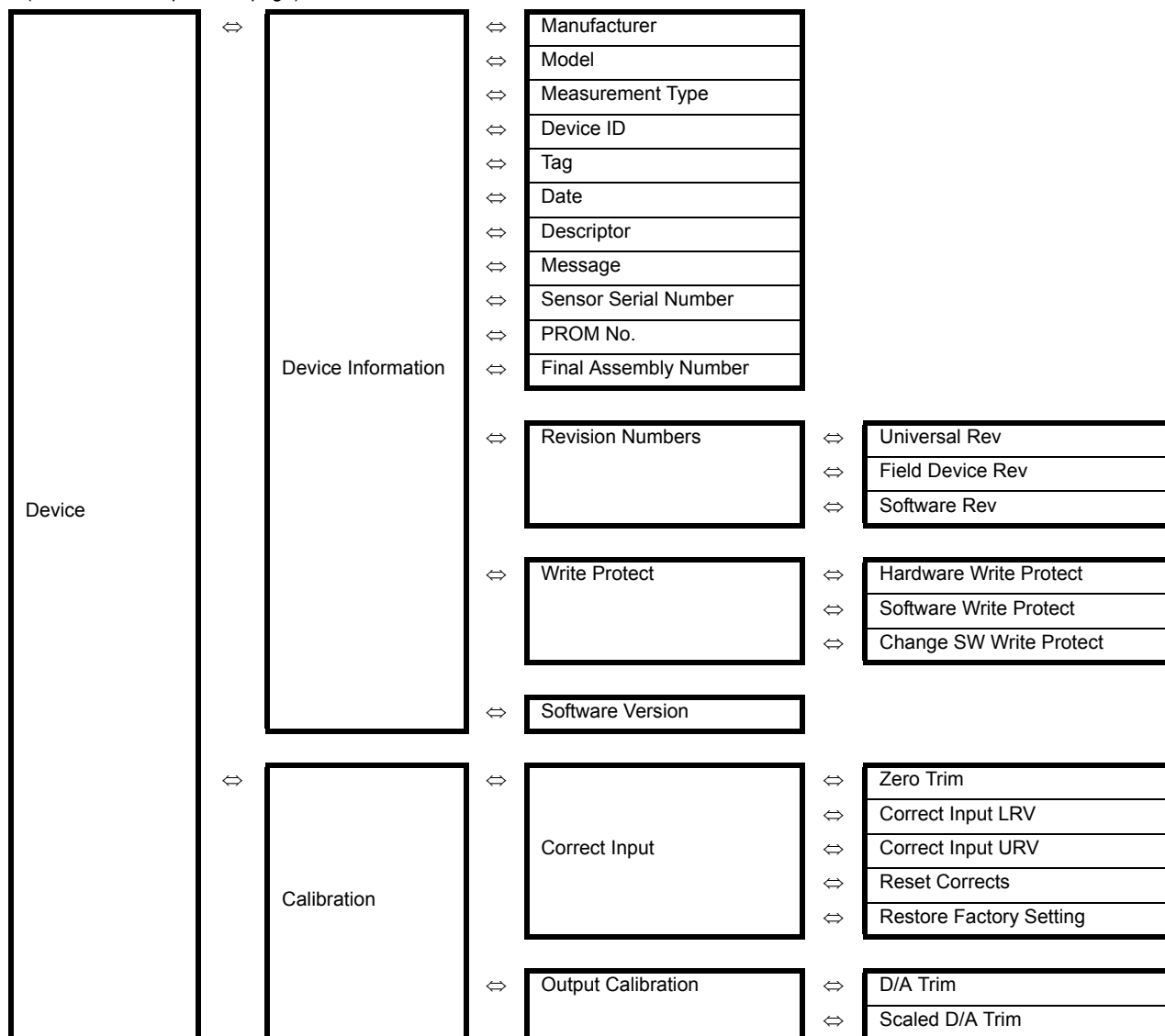

(Continued)

(Continued from previous page)

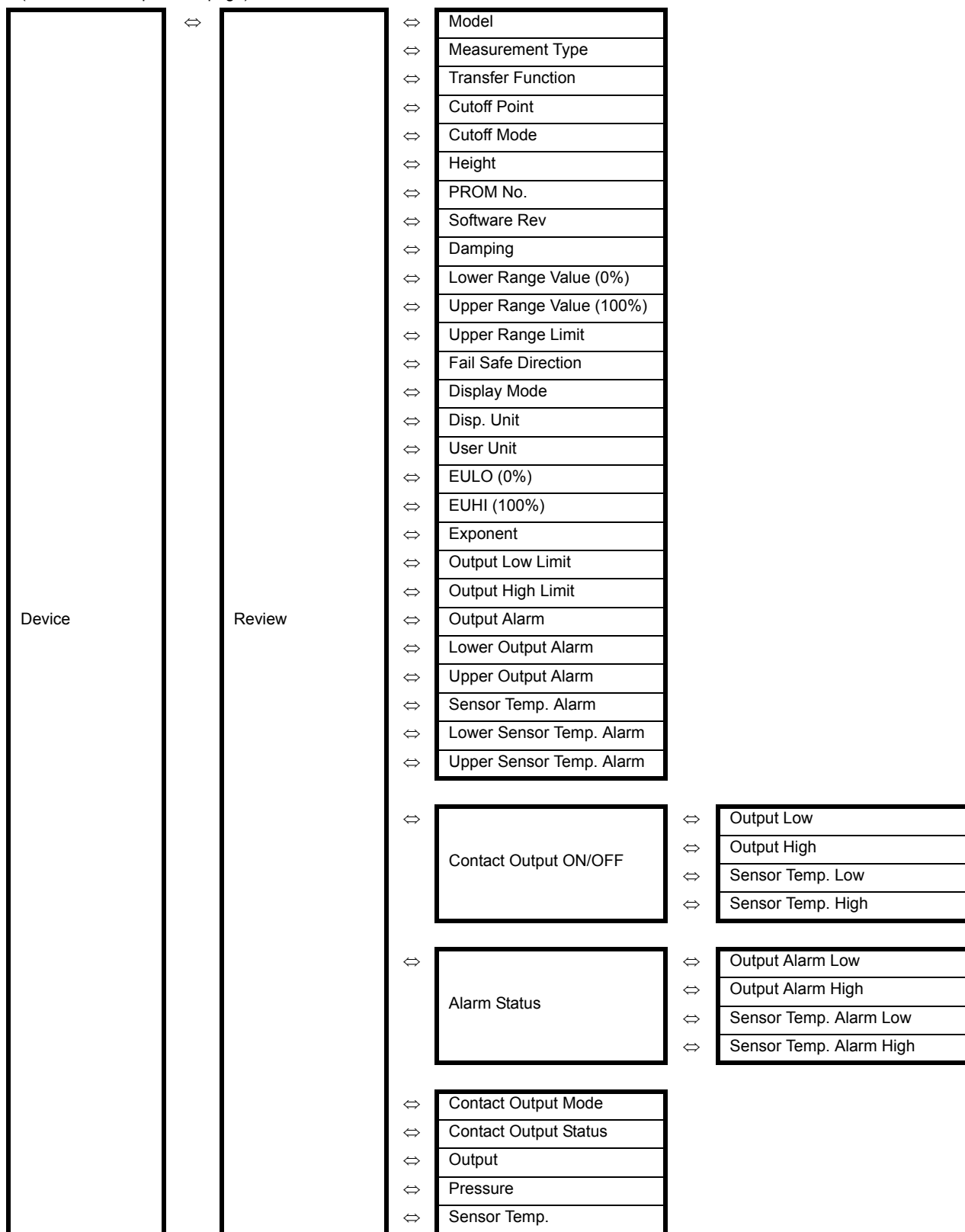

4.6 : Diagnostic menu summary

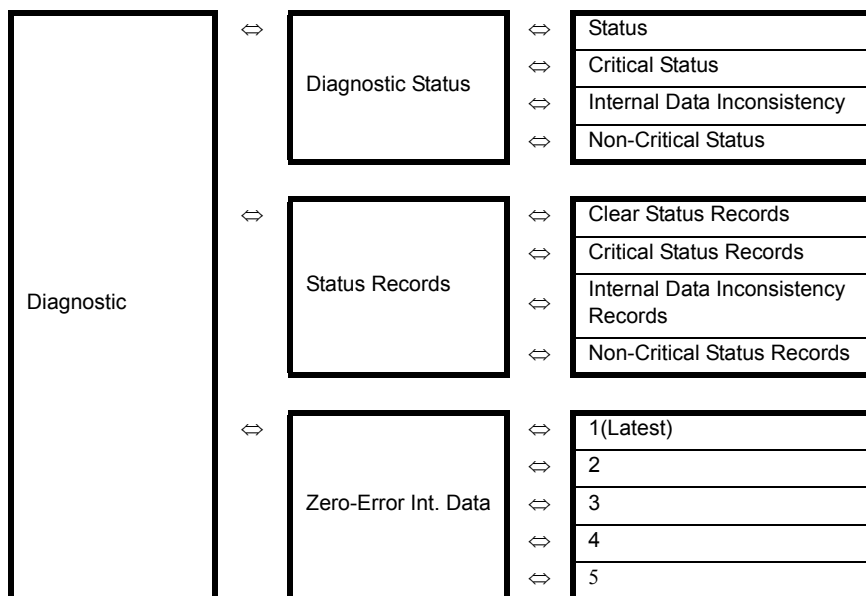

4.6.1 :Changing tag no.

This shows how to change or enter tag number.
(Device) - (Basic setup) - (Tag)

After entering a tag number with pressing ENTER, press SEND to download the change to the transmitter.

4.6.2 :Changing output format

This shows how to change output format, which linear calculation or square root calculation used for measuring differential pressure between a primary element with DP type transmitter.

(Device) - (Basic setup) - (Transfer Function)

4.6.3 :Indicator display format

This shows how to configure display format and/or its ranges.

(Device) - (Display)

Menu items when Display Mode is%:

- 1 Display Mode
- 2 Display Function
- 3 Transfer Function

Menu items when Display Mode is Pressure:

- 1 Display Mode
- 2 Transfer Function

Menu items when Display Mode is scale:

- 1 Display Mode
- 2 Display Function
- 3 Transfer Function
- 4 EULO (0%)
- 5 EUHI (100%)
- 6 Disp Unit
- 7 User Unit
- 8 Exponent

Display Mode

%:	Displaying PV with %
pressure:	Displaying PV with pressure unit
scale:	Displaying scaling PV

Display Function

Linear:	Displays linear.
Square root:	Displays flow by square root extraction.

EULO (0%) / EUHI(100%)

EULO and EUHI must be configured between -19999 and +19999 to indicate PV with an engineering unit.

EULO (0%):	The value to be indicated when the output is 0%
EUHI (100%):	he value to be indicated when the output is 100%

Disp Unit

Engineering Unit to be displayed.

Exponent

Selects the exponent (X10, X100, etc.) for the device display.

X1
X10
X100
X1000

User Unit

User Unit is user defined unit to be display.

4.6.4 :Change Cutoff Mode

This shows how to configure low flow cut value.

This function is effective only when Square Root is selected for the output format.

(Device) - (Signal condition) - (Change Cutoff Mode)

Def. (7.1%Lin.):Cutoffmode is default.(Flowmode is default, dropout is linear, and dropout point is 7.1%.)

Zero. Flow:Def.:Dropout is zero, and flowmode is default.

Lin. Flow:Def.:Dropout is linear, and flowmode is default.

Zero. Flow:Bi-dir.:Dropout is zero, and flowmode is bi-directional.

Lin. Flow:Bi-dir.:Dropout is linear, and flowmode is bi-directional.

Dropout: Select behavior below the cutoff value. Select either zero or linear.

Flow mode: Select calculation method of flow output. Select either default (square root of positive output) or bi-direction (square root of both positive and negative outputs).

4.6.5 :Selecting unit of measurement

This function is to select a pressure unit of the transmitter.

(Device) - (Sensors) - (Pressure Unit)

A pressure unit is able to be selected from the following;

inH₂O
inHg
mmH₂O
mH₂O
mmHg
psi
bar
mbar
g/Sqcm
kg/Sqcm
Pa
kPa
MPa
hPa
Torr
atm

4.6.6 :Setting range values

This is to configure the measuring range of the transmitter.

(Device) - (Signal Condition)

- Select Lower Range Value (0%) or Upper Range Value (100%) to key in the desired setting.
- Press ENTER. This takes you back to “Signal Condition” menu.
- Press SEND to download change to transmitter.

If the number of digit you key in is more than four, the set range is not appeared on “Signal Condition” menu.

4.6.7 :Adjusting damping time

You can adjust the damping time to reduce the output noise.

(Device) - (Signal condition) - (Damping)

When in the damping menu, key in appropriate damping time from 0.0 to 128.0, and the press ENTER. A prompt will appear on the display when you entered an invalid damping value.

4.7 : Start-up and Operation

This section identifies how to access typical data associated with the start-up and the operation of AT9000 with HART® communication option. It includes the procedure for running an analog output check

4.7.1 :Running analog output check

You can put the transmitter into a constant-current source mode, which maintains the output that is set between 4 mA (0%) and 20 mA (100%).

This shows how to configure the transmitter in a constant-current source mode and to return to its original output.

(Device) - (Output condition) - (Analog output) - (Loop test)

You will be prompted to put the loop into manual mode. After doing so, press OK.

- Select 4 mA to set the output signal level to 4 mA (0%).
- Select 20 mA to set the output signal level to 20 mA (100%).
- Select Other and press ENTER, then use communicator's keyboard to enter other values.
- Select End and press ENTER. The communicator will notify you that it is returning transmitter to its original output.

4.7.2 :Configuring ranges with applying pressure

This shows how to configure ranges with applying 4 mA /20 mA input pressure.

(Device) - (Signal condition) - (Apply zero values)

You will be warned to remove the loop from automatic control. After doing so, press OK.

- A display will prompt you to apply new 4mA input.
When "Current applied process value" display appears, choose "Set as 4 mA value" then press ENTER.
Return the loop to automatic.

(Device) - (Signal condition) - (Apply span value)

You will be warned to remove the loop into manual mode. After doing so, press OK.

- A display will prompt you to apply new 20mA input.
When "Current applied process value" display appears, choose "Set as 20 mA value" then press ENTER.
Return the loop to automatic.

4.7.3 :Alarm Settings

This shows how to configure alarm and contact output operations.

(Device) - (Alarm) - (Alarm Settings)

Two kinds of alarm are available: Output alarm and Sensor Temp. alarm.

When alarm condition is detected, it is logged in the status history of the device.

Output alarm

There are 4 settings of configuration.

(Alarm Settings) - (Output Alarm)

Alarm settings: No Alarm, Lower limit, Upper Limit, Lower/Upper Limit.

Lower Limit: Threshold of the Lower Limit alarm (Setting range: -200% to 200%)

Upper Limit: Threshold of the Upper Limit alarm (Setting range: -200% to 200%)

Setting values with the Upper Limit less than or equal to the Lower Limit is prohibited

Operation

The following operations are executed depending on the alarm setting.

- Lower/Upper Limit: If the output value is greater than or equal to the upper limit, or the output value is less than or equal to the lower limit, the alarm is detected.
- Upper Limit: If the output value is greater than or equal to the upper limit, the alarm is detected.
- Lower Limit: If the output value is less than or equal to the lower limit, the alarm is detected.
- No Alarm: No alarm is detected regardless of what value the output value, upper limit, or lower limit is.

The hysteresis is fixed and always 5% of the output.

<Example of the operation>

Alarm settings = Lower/Upper Limit, Upper Limit = 85%, Lower Limit = 15%

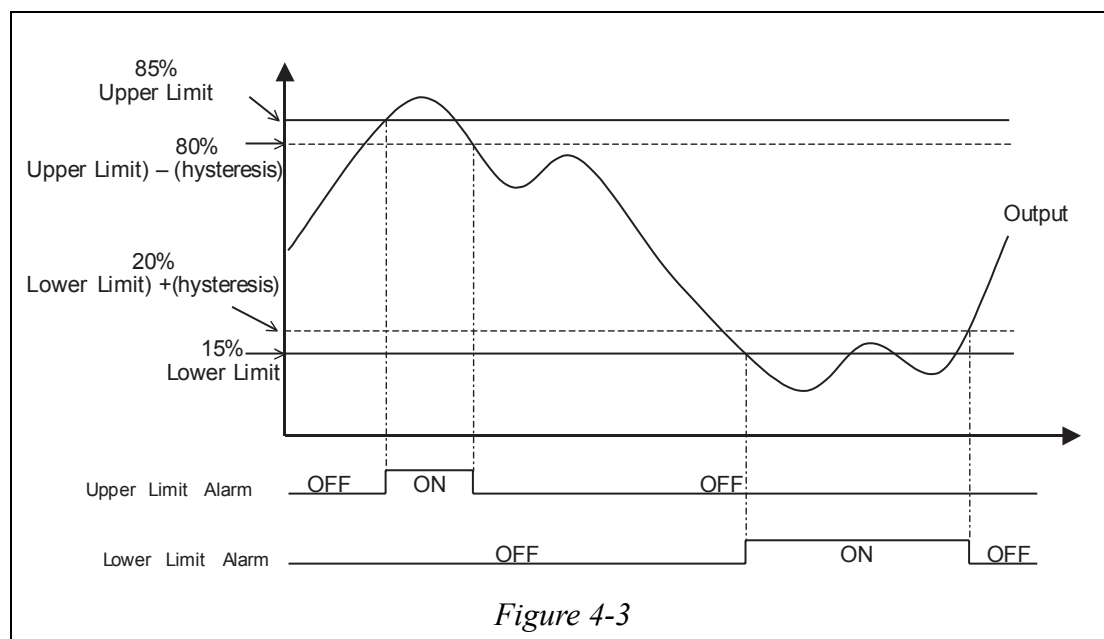

Sensor Temp. alarm.

There are 4 settings of configuration.

(Alarm Settings) - (Sensor Temp. Alarm)

Alarm settings: No Alarm, Lower limit, Upper Limit, Lower/Upper Limit.

Lower Limit: Threshold of the Lower Limit alarm (Setting range: -40 to 85 degrees Celsius)

Upper Limit: Threshold of the Upper Limit alarm (Setting range: -40 to 85 degrees Celsius)

Setting values with the Upper Limit less than or equal to the Lower Limit is prohibited

Operation

The following operations are executed depending on the alarm setting.

- Lower/Upper Limit: If the sensor temperature is greater than or equal to the upper limit, or the sensor temperature is less than or equal to the lower limit, the alarm is detected.
- Upper Limit: If the sensor temperature is greater than or equal to the upper limit, the alarm is detected.
- Lower Limit: If the sensor temperature is less than or equal to the lower limit, the alarm is detected.
- No Alarm: No alarm is detected regardless of what value the sensor temperature, upper limit, or lower limit is.
The hysteresis is fixed and always 5% of the output.

<Example of the operation>

Alarm settings = Upper Limit, Upper Limit = 70 degrees Celsius, Lower Limit = -20 degrees Celsius.

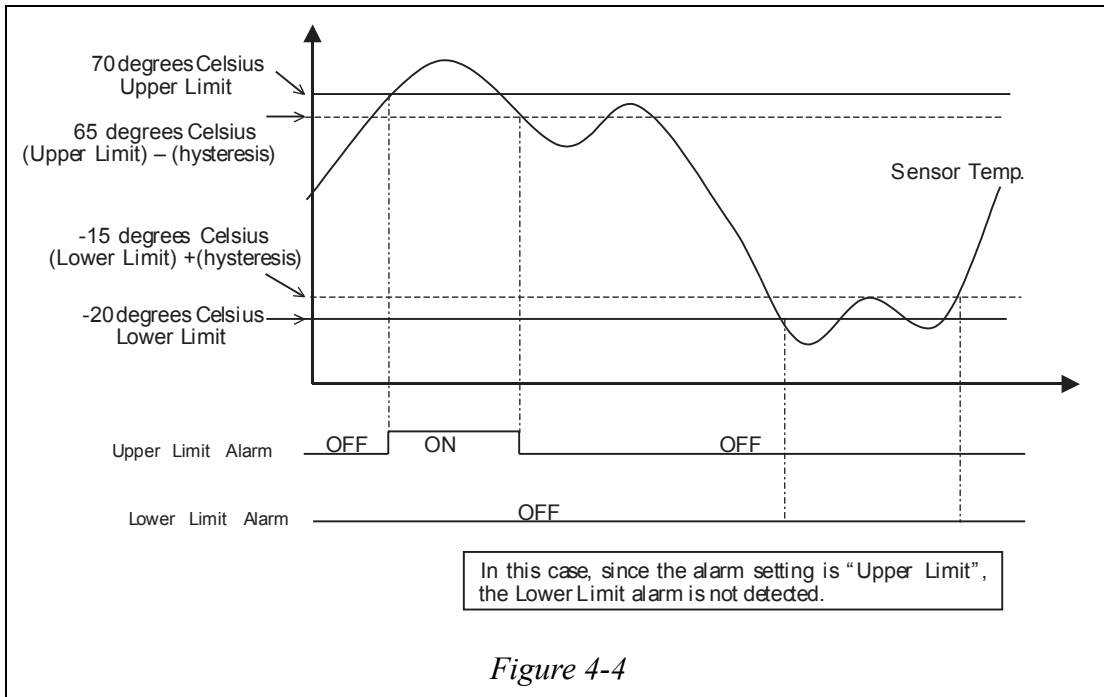

Contact Output (Optional)

You can configure and simulate the contact outputs shown below. And you can determine whether or not the contact output is upon detection of an alarm condition.

Contact output can be configured to open or close the circuit upon detection of an alarm condition.

(Device) - (Alarm) - (Alarm Settings) - (Contact Output Mode)

Normally Open: When no alarm is detected - Contact OFF.
 When alarm is detected - Contact ON.

Normally Closed: When no alarm is detected - Contact ON.
 When alarm is detected - Contact OFF.

You can select the process alarms (Output Alarm and Sensor Temp. Alarm) to be reflected in the contact output.

(Device) - (Alarm) - (Contact Output ON/OFF)

You can simulate the Contact Output to "Open", or "Closed".

(Device) - (Alarm) - (Contact Output Simulation Mode)

Open: Contact Output is set to "Open".

Closed: Contact Output is set to "Closed".

Clear: To clear the Simulation Mode.

4.7.4 :Write Protect

This function prevents users from changing the settings of the transmitter using the communicator or external zero/span adjustment function.

There are two types of write protect, hardware write protect and software write protect.

(Device) - (Device Information) - (Write Protect)

Hardware write protect

Switching the write protect ON and OFF can be executed with the slide switch (S1) on the electronics module.

Protect ON: Slide the slide switch (S1) to the ON side.

Protect OFF: Slide the slide switch (S1) to the OFF side.

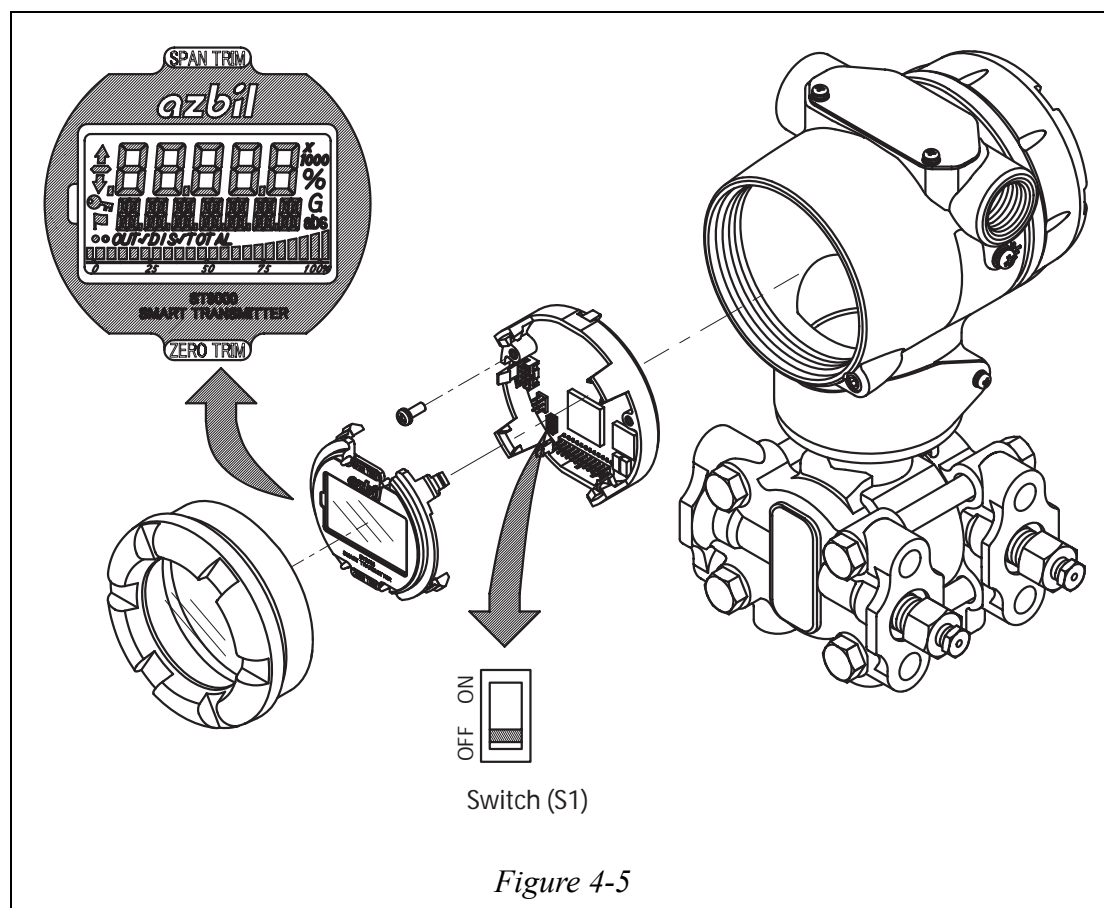

Software write protect

Switching the write protect ON and OFF can be executed with the communicator.

When the hardware write protect is ON, switching with the communicator is not available.

4.8 : Calibration

This section provides information about calibrating the transmitter's analog output and measuring range. It also covers the procedure for resetting calibration to default values.

4.8.1 :Calibrating analog output signal

You can calibrate the transmitter's analog output circuit at its and 100% levels by using the transmitter in its constant-current source mode.

(Device) - (Calibration) - (Output Calibration) - (D/A trim)

STEP	Action/Description
1	<p>You will be warned to remove the loop from automatic control. After doing so, press OK.</p> <p>When prompt appears, connect a precision millimeter or volt meter (0.03% accuracy or better) in loop to check readings. Press OK.</p>
2	<p>The following display prompts will appear:</p> <ul style="list-style-type: none"> • Setting field device output to 4 mA. Press OK. • Enter meter value. Key in meter value, then press OK. • Is field device output 4.000 mA equal to reference meter? 1 Yes 2 No <p>If not equal, select No, press ENTER, then key in new meter value. (returns to “Enter meter value” prompt until field device output equals reference meter.)If equal, select Yes, press ENTER.</p>
3	<p>The following display prompts will appear:</p> <ul style="list-style-type: none"> • Setting field device output to 20 mA. Press OK. • Enter meter value. Key in meter value, then press ENTER. • Is field device output 20.000 mA equal to reference meter? 1 Yes 2 No <p>If not equal, select No, press ENTER, then key in new meter value. (Returns to “Enter meter value” prompt until field device output equals reference meter.) If equal, select Yes, press ENTER. Prompt notifies you that the field device will be returned to its original output.</p>

4.8.2 :Calibrating range

The AT9000 Advanced Transmitter has two-point calibration. This means when you calibrate two points in the range, all the points in that range adjust to that calibration.

(Device) - (Calibration) - (Correct Input)

- Select “Correct Input LRV” or “Correct Input URV”.
- You will be warned to remove the loop from automatic control. After doing so, press OK.
- When prompted, adjust pressure source to apply pressure equal to LRV (0%) or URV (100%), then press OK.
- When pressure is stable, press OK.
- When prompted, remove pressure.

4.8.3 :Resetting calibration

A Corrects Reset returns the zero and span calibration factors to their default values. The transmitter calculates its output based on the characterization equation alone, without any compensation for the residual errors.

(Device) - (Calibration) - (Correct Input) - (Reset Corrects)

- When prompted, remove the loop from automatic control. Press OK.
- Prompt notifies you that a Reset Corrects is about to occur. Press OK.
- When message “Reset Corrects OK” appears, press OK.
- Calibration is reset to default values.
- When prompted, return the loop to automatic control and press OK.

MEMO

Chapter 5 : Maintenance

This section explains the maintenance of the AT9000 Advanced Transmitter and a range of interesting ways to ensure that your transmitter's performance goals may be continuously met during its operating life, including instructions for:

- disassembly and assembly procedures,
- output checking,
- calibration procedures, and troubleshooting procedures.

At the start of operation or during operation, deal with performance problems by following these procedures. If you cannot fix the problem, it is possible that there is a problem with the product itself and you should contact your Yamatake representative immediately.

5.1 : Disassembly and Assembly

5.1.1 : Before You Start

WARNING

- Never open the case cover while the transmitter is ON or in a hazardous location.
- Handle the explosion-proof transmitter with care. It may lose its explosion-proof performance due to corrosion, deformation, damage to the case cover, or damage to a screw or a joined part.
- The explosion-proof performance of the special explosion-proof pressure transmitter is not guaranteed unless it is LOCKED. Always tighten the case cover completely, and lock the case cover.

Opening and Closing the case cover

This transmitter has a locking structure. Before opening the case cover, unlock the mechanism using a hexagonal wrench (included).

When closing, insert the case cover fully and lock it, using a hexagonal wrench.

CAUTION

After closing the case cover, make sure that no dust or rain gains ingress into the transmitter case.

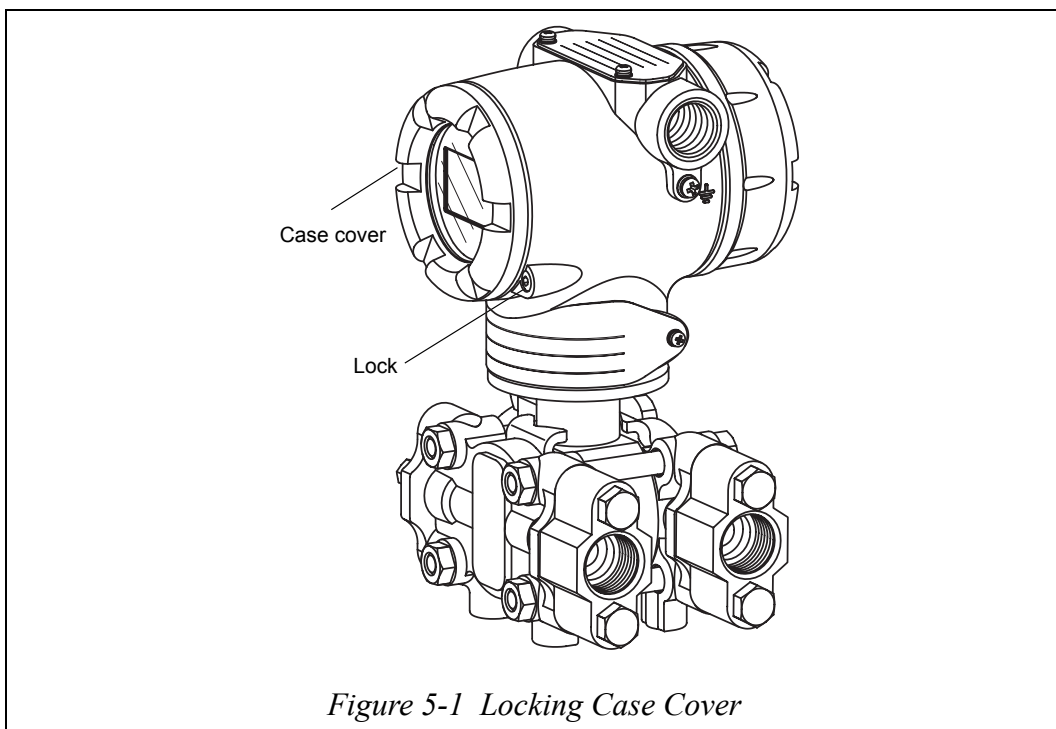

Figure 5-1 Locking Case Cover

5.1.2 :Mount Center Body Cover and Adapter Flange

Remove covers

Remove the four sets of bolts & nuts, shown in the illustration.

Remarks:

After removing, handle the center body cover carefully. Avoid damage to the diaphragm.

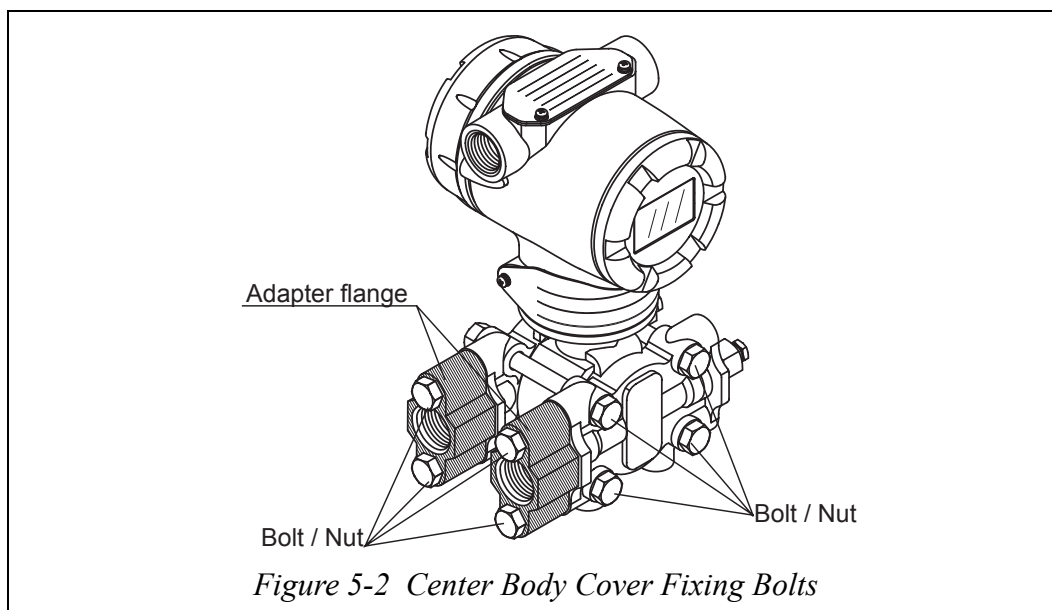

Mount covers and adapter flanges

When assembling the centers body cover and adapter flanges, tighten the bolts to the following torque.

Replace the seal gasket, if it is damaged.

Table 5-1 Cover Bolts / Nuts and Tightening Torque

Model No.	Wetted parts material (other than diaphragm)	Bolt/Nut Material	Bolt/Nut tightening torque N·m		
			Cover material Carbon steel/Stainless steel		Cover material PVC
			When new gasket is used	When existing gasket is reused	When new / existing gasket is used
GTX15D	SUS316	SUS304	15±1	10±1	-
GTX31D GTX41D	SUS316 Hastelloy C	Carbon steel	22±2	17±1	10±1
		SUS630			-
		SUS304	15±1	10±1	10±1
GTX31D GTX41D GTX71D	Tantalum SUS316L	Carbon steel	22±2	17±1	10±1
		SUS630			-
		SUS304	15±1	10±1	10±1
GTX32D GTX42D GTX72D	SUS316	Carbon steel SUS630	90±20		-
		SUS304	55±10		-
GTX60G GTX71G	SUS316 Hastelloy C	Carbon steel	22±2	17±1	10±1
		SUS630			-
		SUS304	15±1	10±1	10±1
GTX60G GTX71G	Tantalum SUS316L	Carbon steel	22±2	17±1	10±1
		SUS630			-
		SUS304	15±1	20±1	10±1
GTX82G	SUS316 Hastelloy C	Carbon steel SUS630	90±20		-
		SUS304	55±10		-
GTX30A GTX60A	SUS316 Hastelloy C Tantalum SUS316L	Carbon steel SUS630	22±2	17±1	-
		SUS304	15±1	10±1	10±1
GTX35F GTX60F	SUS316	Carbon steel SUS630	22±2	17±1	-
		SUS304	15±1	10±1	-

Table 5-2 Adapter Flange Bolt / Nut Tightening Torque

Bolt/Nut Material	Bolt/Nut tightening torque N·m	
	Adapter flange material Carbon steel/Stainless steel	Adapter flange material PVC
Carbon steel	20±1	7±0.5
SUS630		-
SUS304	10±0.5	7±0.5

5.1.3 :Washing the Center Body

Introduction

The transmitter and the pipes must be kept clean to maintain its accuracy and achieve satisfactory performance. Deposits accumulated in the pressure chamber of the transmitter may result in measurement errors.

Rinsing the center body (GTX□□D/GTX□□A/GTX□□G/GTX□□F)

Rinse the center body using the following procedure:

- (1) Remove the hexagon head bolts of the center body and removed the cover.
- (2) Wash the diaphragm and the inner surface of the cover with a solvent and a soft brush. Take care not to deform or damage the diaphragm.
- (3) In reassembling the center body, replace the cover gasket with a new one as necessary.
- (4) Tighten the cover bolts at the specified tightening torque. (Refer to "Table 5-1 Cover Bolts / Nuts and Tightening Torque")

Remarks related to cold area

If you stop the operation after measuring liquid that can be frozen (such as water) in a cold area, drain the liquid from the center body (by loosening the drain plug.)

Maintenance of sensor

The sensor does not need any special routine maintenance/inspection. When the flange is removed for maintenance, wash the diaphragm using a soft brush and solvent. Work carefully without deforming or damaging the diaphragm.

5.2 : Calibrating Set Range and Output Signals

Some calibration work must be performed by Yamatake or our authorized service provider. Generally, this work requires a high-precision reference input device and highly accurate measuring equipment. Such work is not ordinarily performed by end-users of Yamatake equipment. These instructions are provided for the benefit of users who must perform calibration work themselves.

Calibration includes input calibration (set range) and output calibration (output signals).

5.2.1 : Calibrating Set Range Based on Reference Input

Preparation

The low limit (LRV) and the high limit (URV) of the set range are calibrated by inputting reference pressure.

Calibrate the LRV and the URV, in that order.

Equipment

Prepare the following equipment before calibration:

- Standard pressure generator: Pressure generated must be close to the measurement range of the transmitter.
Accuracy requirement: $\pm 0.05\%$ F.S. or $\pm 0.1\%$ setting
- Power supply: 24V DC
- Precision resistance: $250\ \Omega \pm 0.005\%$
- Voltmeter: Digital voltmeter with accuracy (10V DC range) of $\pm 0.02\%$ rdg+1 dgt
- HART® communicator

Calibration conditions

All of the following conditions must be met, before performing calibration:

- A laboratory without any air currents. Wind will apply pressure to the pressure receiving unit on the side open to the air, influencing the calibration accuracy.
- Standard temperature of 23°C and humidity of 65%. Normal pressure range ($15^{\circ}\text{C}\sim 35^{\circ}\text{C}$) and the normal humidity range (45%~75%) are allowable, if no sudden changes occur.
- Accuracy of the measuring equipment must be at least 4 times that of the transmitter.

CAUTION

If damping time constant is set to 0 sec. please adjust another value to keep the output stable before calibration. (Refer to "3.2.9 : Adjusting Damping Time Constant")

Set up for calibration

Wire the transmitter in a similar way to that shown below.

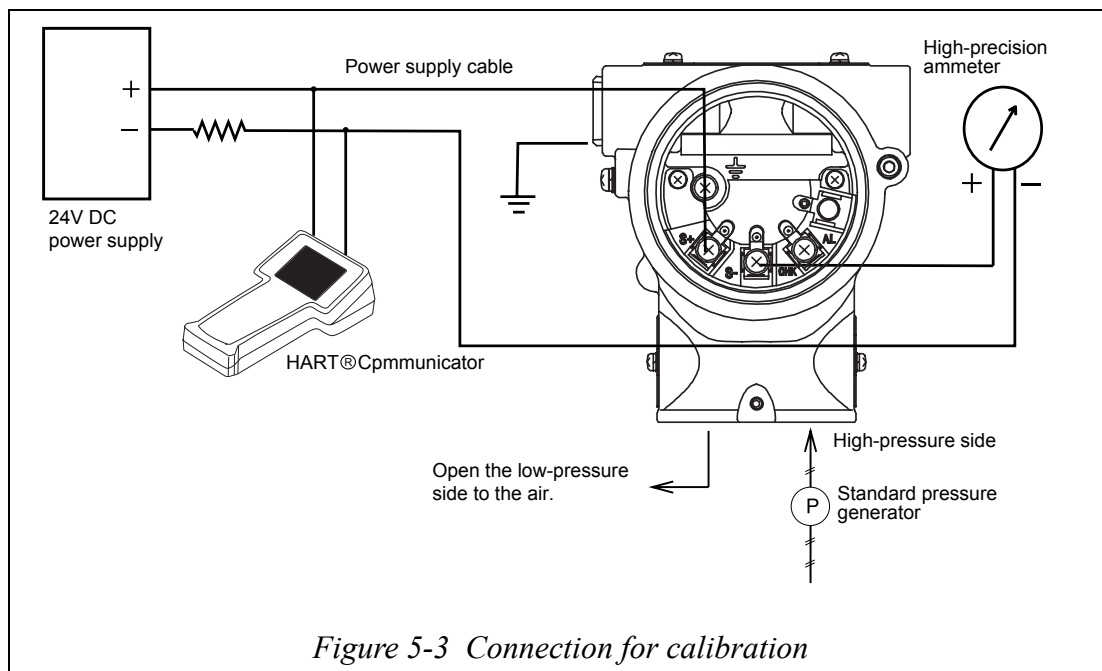

Set range

Before starting calibration work, use the HART® Communicator to check that the set range of the transmitter agrees with the specifications. If they do not correspond, use the HART® Communicator to set the correct range.

Calibrating Low Limit

How to calibrate the low limit value:

It is assumed that the HART® communicator and the transmitter have just started normal communications.

The AT9000 Advanced Transmitter has two-point calibration. This means when you calibrate two points in the range, all the points in that range adjust to that calibration.

(Device) - (Calibration) - (Correct Input)

- Select “Correct Input LRV”.
- You will be warned to remove the loop from automatic control. After doing so,
- press OK.
- When prompted, adjust pressure source to apply pressure equal to LRV (0%) then press OK.
- When pressure is stable, press OK.
- When prompted, remove pressure.

Calibrating High Limit

How to calibrate the high limit value:

(Device) - (Calibration) - (Correct Input)

- Select “Correct Input URV”.
- You will be warned to remove the loop from automatic control. After doing so,
- press OK.
- When prompted, adjust pressure source to apply pressure equal to URV (100%) then press OK.
- When pressure is stable, press OK.
- When prompted, remove pressure.

5.2.2 :Calibrating Output Signals

Before You Start

Output signal calibration (adjustment of the D/A conversion unit) is unnecessary under ordinary operating conditions. Normally, this work is performed by an authorized service provider of Yamatake. For end-users who must perform this work, prepare the following equipment in advance:

Equipment

- High-precision ammeter with accuracy of 0.03% FS or higher
- Resistor with a resistance of $250\Omega \pm 0.005\%$
- HART® communicator

Set-up

Refer to Figure 5-4. Connect the HART® communicator and an ammeter.

Refer to 3.2.1 Starting Communications. Check to ensure proper wiring. Check that the HART® communicator and the transmitter are in the normal communication status.

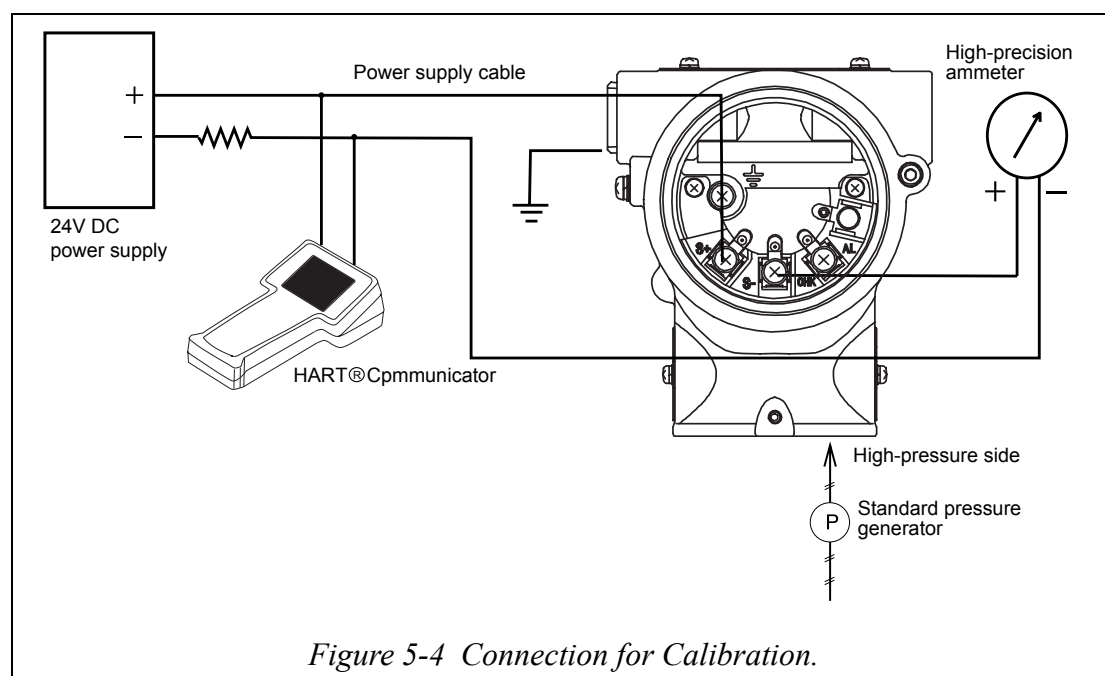

Calibrating Analog Output Signal

You can calibrate the transmitter's analog output circuit by using the transmitter in its constant-current source mode.

(Device) - (Calibration) - (Correct Input) - (D/A trim)

STEP	Action/Description
1	<p>You will be warned to remove the loop from automatic control. After doing so, press OK.</p> <p>When prompt appears, connect a precision milliammeter or volt meter (0.03% accuracy or better) in loop to check readings. Press OK.</p>
2	<p>The following display prompts will appear:</p> <ul style="list-style-type: none"> • Setting field device output to 4 mA. Press OK. • Enter meter value. Key in meter value, then press OK. • Is field device output 4.000 mA equal to reference meter? 1 Yes 2 No <p>If not equal, select No, press ENTER, then key in new meter value. (returns to “Enter meter value” prompt until field device output equals reference meter.) If equal, select Yes, press ENTER.</p>
3	<p>The following display prompts will appear:</p> <ul style="list-style-type: none"> • Setting field device output to 20 mA. Press OK. • Enter meter value. Key in meter value, then press ENTER. • Is field device output 20.000 mA equal to reference meter? 1 Yes 2 No <p>If not equal, select No, press ENTER, then key in new meter value. (Returns to “Enter meter value” prompt until field device output equals reference meter.) If equal, select Yes, press ENTER. Prompt notifies you that the field device will be returned to its original output.</p>

Chapter 6: Troubleshooting

The following describes the meaning of the status messages and the related troubleshooting procedures.

	Status message	Meaning	Required action	Display of Indicator
Internal data inconsistency	Invalid database	Configuration data and/or calibration data is corrupt.	Tap [Exit] and try communicating again. Verify configuration data and recalibrate the device.	Err.09 CONFIG
Critical failure	Analog/Digital Conversion Fault	Analog/Digital conversion failure	Invalid sensor and/or electronics board. Contact appropriate personnel.	Err.01 A-D CNV
	Sensor Characteristic Data Fault	Sensor characteristic data failure	Contact appropriate personnel.	Err.02 PROM
	Suspect Input	Input data error	Invalid sensor and/or electronics board. Contact appropriate personnel.	Err.03 INPUT
	CPU Fault	CPU operation failure	Bad electronics board. Contact appropriate personnel.	Err.04 CPU
	NVM Fault	Nonvolatile memory failure	Bad electronics board. Contact appropriate personnel.	Err.05 NVM
	RAM Fault	RAM failure	Bad electronics board. Contact appropriate personnel.	Err.06 RAM
	ROM Fault	ROM failure	Bad electronics board. Contact appropriate personnel.	Err.07 ROM
	Output Circuit Fault	Output circuit failure	Bad electronics board. Contact appropriate personnel.	Err.08 OUTPUT

	Status message	Meaning	Required action	Display of Indicator
Non-critical status	Meter Body Over Temperature	Meter body temperature is too high.	Reinstall the device to decrease the temperature to within specifications.	AL.20 M/B.TEMP
	Excess Zero Correct	The zero correction factor is outside the acceptable limits for accurate operation.	Check the input and be sure it matches the calibrated range value.	AL.21 ZERO.CAL
	Excess Span Correct	The span correction factor is outside the acceptable limits for accurate operation.	Check the input and be sure it matches the calibrated range value.	AL.22 SPAN.CAL
	In Output Mode	The device is operating in output mode.	Go to the output mode menu to clear the output mode.	Output % OUTMODE
	Meter Body Overload or Meter Body Fault	- The input pressure is more than two times The upper range limit for The device. - Device error.	Check the PV value and replace the device with a larger range model if necessary.	AL.24 OVRLOAD
	Correct Reset	Calibration data is cleared.	Calibrate the lower and upper range values.	AL.26 NO.CALIB
	External Zero/Span Adjustment Fault	External zero/span adjustment error.	Contact appropriate personnel.	AL.28 SWITCH
	Contact Output Simulation Mode	The device is operating contact output simulation mode.	To clear contact output simulation mode, go to the alarm/contact output menu.	[Brank] DO.SIM
	Output Alarm Detected	The output is going over upper/lower limit of output alarm.	Check the output.	AL.51 OUT%.AL
	Sensor Temp. Alarm Detected	The sensor temperature is going over upper/lower limit of sensor temp. alarm.	Check the sensor temperature.	AL.52 TEMP.AL

If the transmitter does not work normally or at all, check the following items.

Phenomenon	Measures
Nothing appears on the display.	<ul style="list-style-type: none"> • Make sure the power supply voltage is correctly applied. • Make sure the wire connection of the power supply is provided.
Output remains zero and does not change.	<ul style="list-style-type: none"> • Make sure the settings are correct. • Make sure the flow rate is within the low flow cut range. • Make sure the pipes are not blocked.
Output is out of alignment.	<ul style="list-style-type: none"> • Make sure that no fluid is leaking from the pipes. • Make sure the fluid is not flowing backward. • Make sure the connection direction of the HP and LP sides is correct. • Make sure the transmitter is not set at a tilt.

Also check the following points.

- Check the result of self-diagnosis with the Communicator.
- Check that the connection direction of the HP and LP sides is correct.
- Check for any leakage at the connections on the pipes.
- Check for any loosened bolts on the clamping portions of the product.
- Check for any loosened and/or broken wires.
- Check for any wrong wiring connections.
- Check that the power supply voltage and load resistance are in accordance with the specifications.
- Check that the pressure and temperature are in accordance with the specifications.
- Check for the presence of any sources of strong magnetism or noise near by.

If even after checking the above items the transmitter still does not work properly, stop using it and unplug it. Then contact us at our branch office, sales office, or your local representative.

MEMO

Appendix A - Supplement Manual for CommPad

Section 1 : Introduction

CommPad is a communicator used for configuration of various settings and parameters of Yamatake smart field instruments. The hardware components of CommPad are a Pocket PC (CASIO IT-10) with a communication card and communications cable.

This operation manual explains how to operate CommPad with the AT9000 Advanced Transmitter, one of the instruments that is compatible with CommPad. Please refer to the Common Edition of the user's manual (CM2-CFN100-2001) for instructions common to all instruments, such as how to install CommPad. Before reading the present manual, please read the Common Edition.

Please refer to the AT9000 Advanced Transmitter user's manual (CM2-GTX100-2001) for information on functions specific to the Advanced Transmitter.

Note: After starting communication with CommPad, if you adjust the zero/span point using the external zero/span adjustment function, only the data in the transmitter will be changed, leaving a data inconsistency between the transmitter and CommPad. After manual zero adjustment you must go to the Home screen and tap [Start]. This will eliminate the data inconsistency.

This manual contains instructions for the following models.

AT9000 Advanced Transmitter Model GTX.

Section 2 : How to Connect Your CommPad to the Advanced Transmitter

Please see "Figure A-1 Wiring for connection with Model GTX" for instructions on connecting CommPad.

Note: Do not connect two or more communicators (including Model SFC Smart Field Communicators) at the same time.

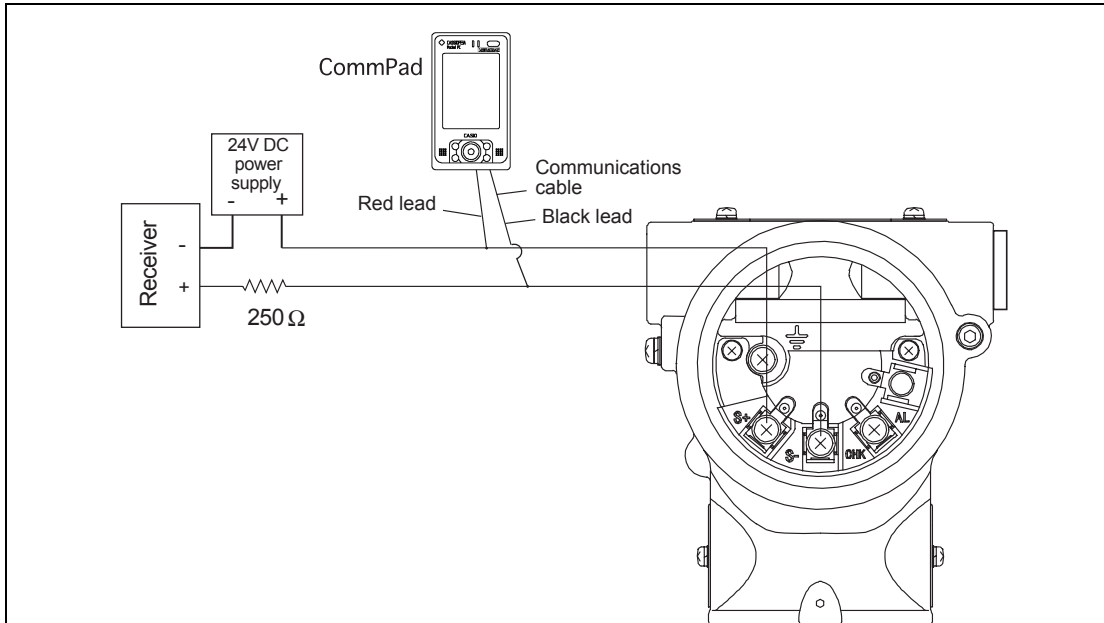

Note: Always connect CommPad's communications cable to the loop wiring as follows:

- Always connect
- Red lead: S+ terminal
- Black lead: S- terminal

Figure A-1 Wiring for connection with Model GTX

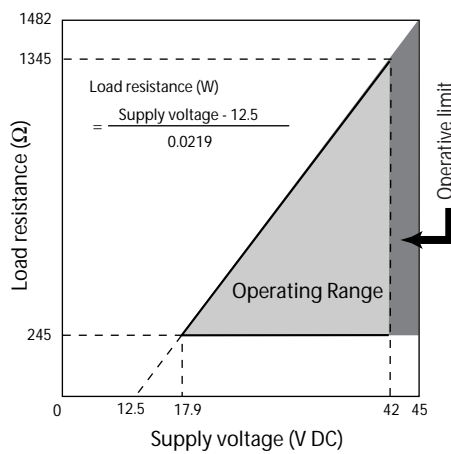
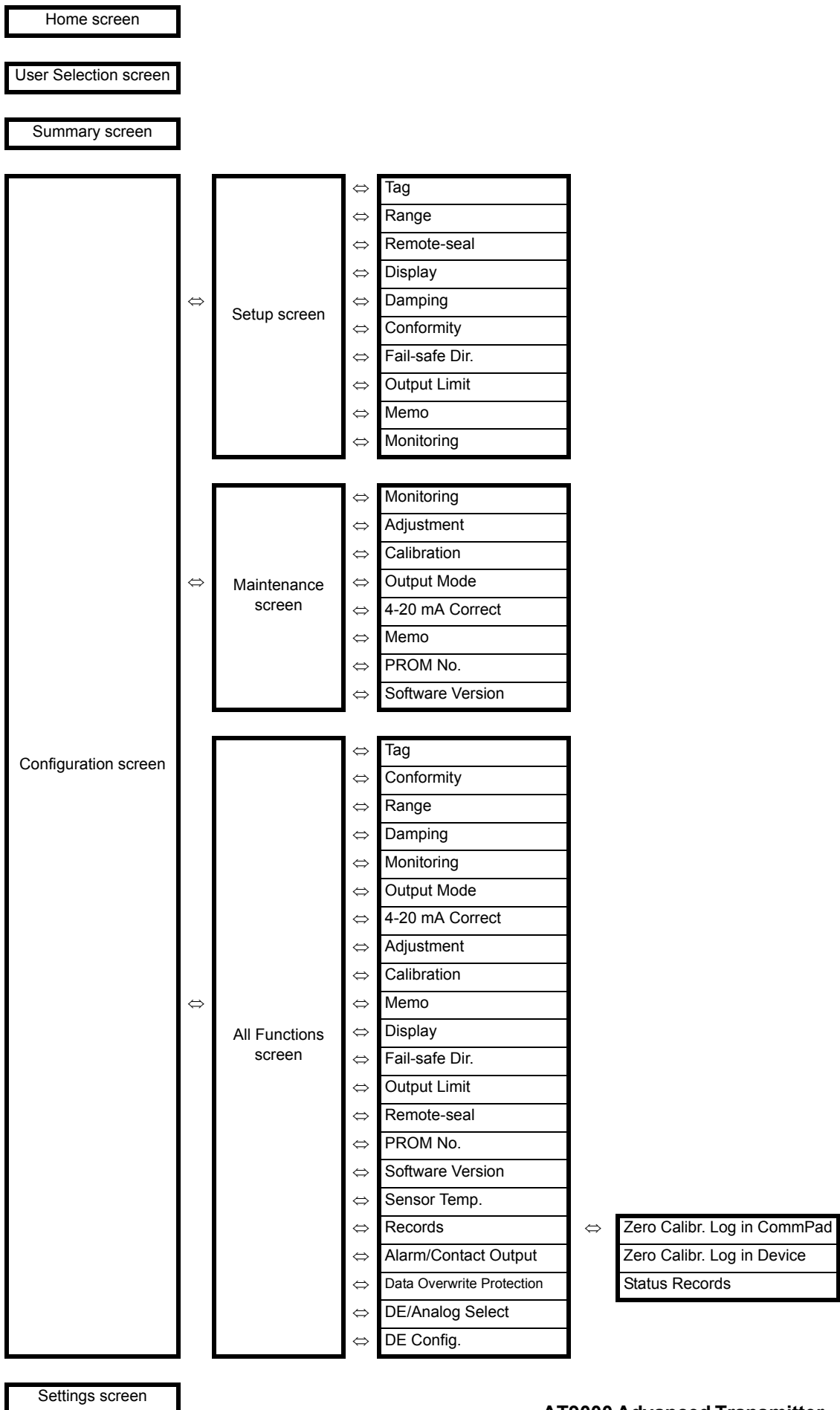

Figure A-2 Supply voltage vs. load resistance

Section 3 : Menu Structure

The menu structure of CommPad is shown on the next page. Each menu is described in detail in Section 4, “How to Operate CommPad.”



Section 4 : How to Operate CommPad

4.1: How to Start CommPad

Please refer to the CommPad User's Manual (Common Edition).

4.2: Home Screen

When you start CommPad, caution messages appear. Tap [OK] and the Home screen shown below appears. For more information, please refer to the CommPad User's Manual (Common Edition). Connect the communications cable to the communication port of the instrument and tap [Start.]

CAUTION

Make sure that the controller in the control loop is in manual mode before starting communications.

When you tap [Start], CommPad starts digital communications with the connected instrument by generating an alternating current signal (4 mA / 20 mA). Be extra careful if there is a valve in the control loop, a malfunction may result.

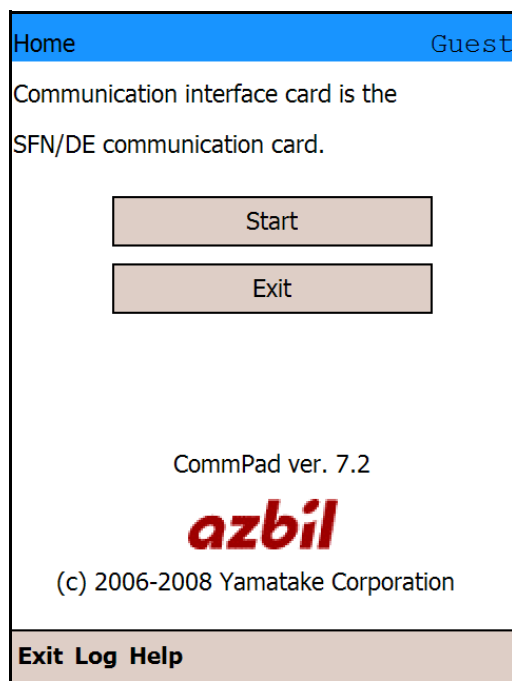

4.3: User Selection Screen

After you start CommPad, tapping [Start] shows the User Selection screen. For more information, please refer to the CommPad User's Manual (Common Edition).

- (1) Either select one of the registered user names or the default user name "Guest" and tap [OK].

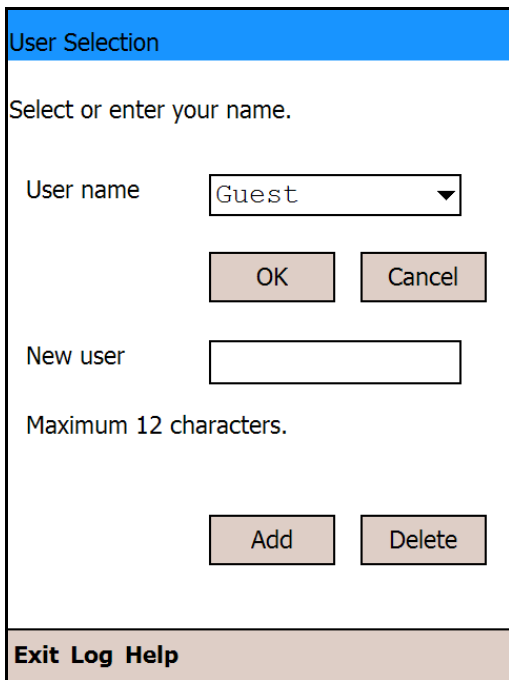

- (2) Make sure that the control loop is in manual mode, and then tap [Yes].



- (3) Confirm that no problems will occur even if the current signal fluctuates, and tap [Yes] to start communications.

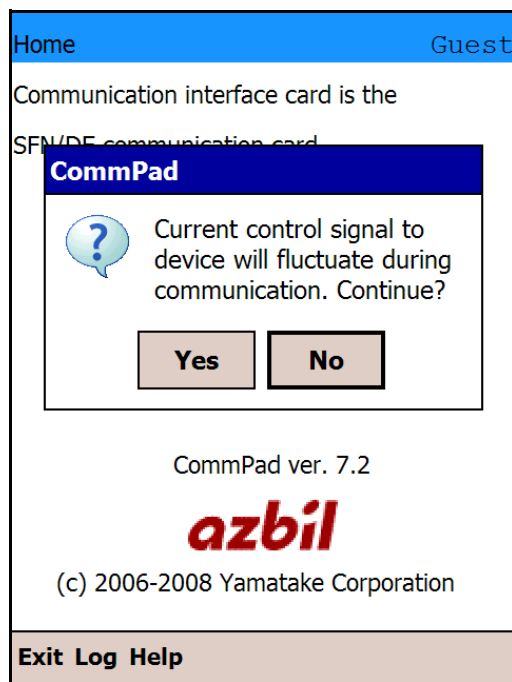

After the process is complete, the Summary screen will appear.

4.4: Summary Screen

The Summary display includes Output, Input, LRV, URV, and Conformity. Tapping [Read Output and Input] rereads Output and Input and updates the displays.

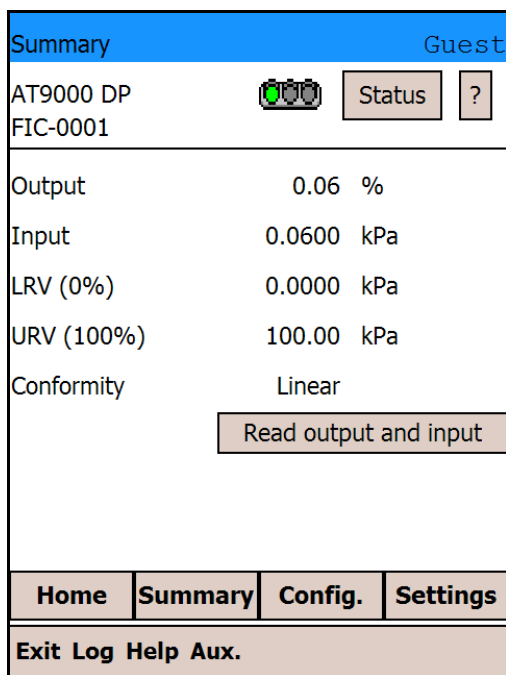

4.5: Status Screen

Tapping [Status] shows the result of self-diagnosis by the device. For more information on the messages, see chapter 6, "Troubleshooting."

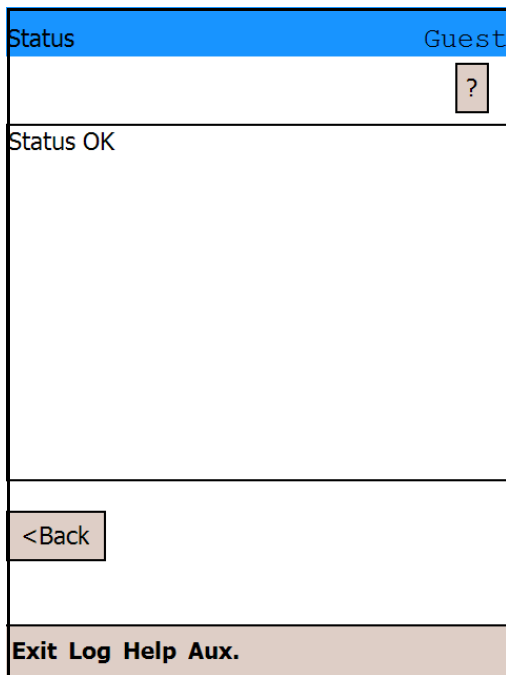

4.6: Help Screen

Tapping [?] on any screen allows you to use the help function, showing a description of the current screen.

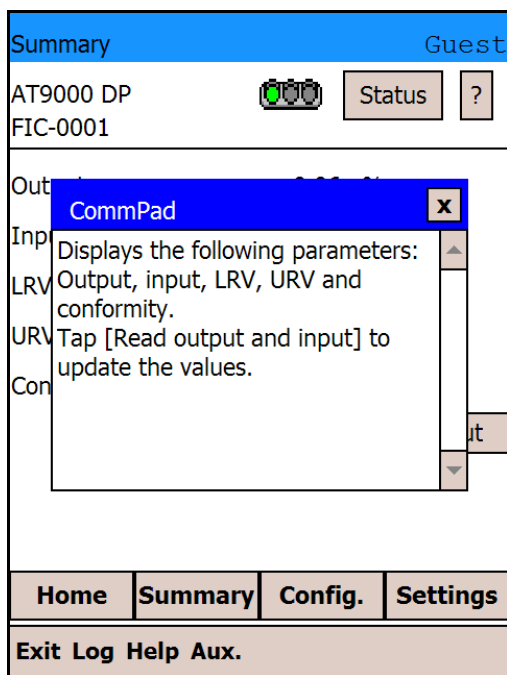

4.7: Configuration Screen

To configure the settings for the device, first tap [Configuration]. There are three lists of configurable settings:

- Setup
- Maintenance
- All Functions

Tap [Setup] to display and configure functions required before operating the device.

Tap [Maintenance] to display and configure functions required for device maintenance.

Tap [All Functions] to display and configure all available functions.

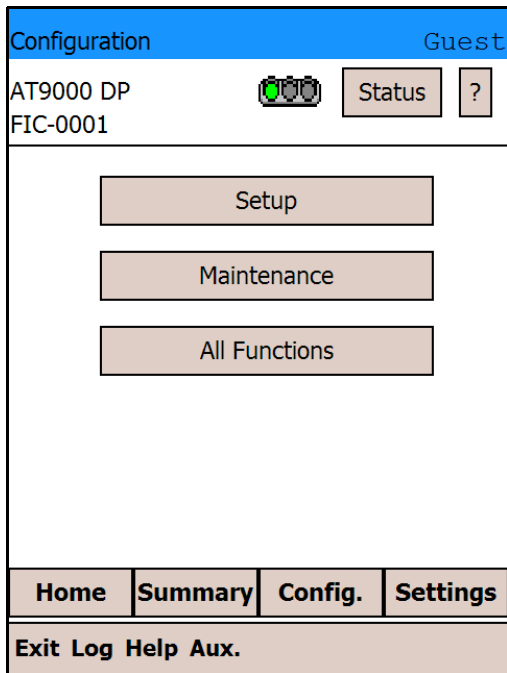

4.8: Setup Screen

Tapping [Setup] on the Config. screen shows the Setup screen.

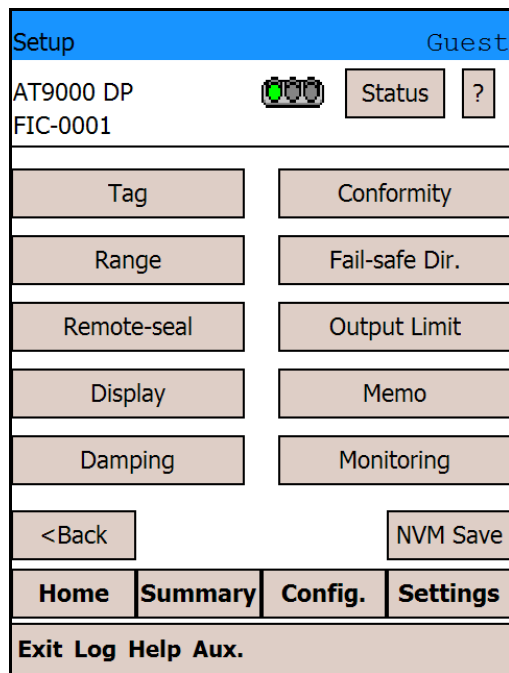

Nonfunctional buttons on the screen are displayed in gray. The following buttons are nonfunctional under the specified conditions:

[Output Limit]

The Output Limit function is available in analog mode.

[Remote-seal]

Does not function if the device is not a remote-seal model.

4.9: Maintenance Screen

Tapping [Maintenance] on the Config. screen shows the Maintenance screen.

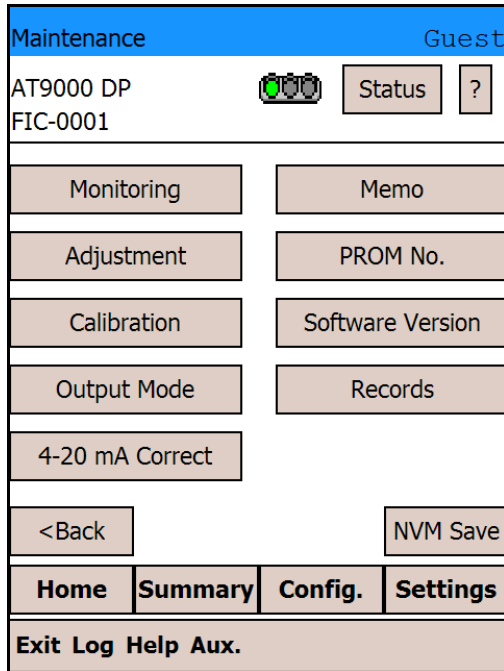

Nonfunctional buttons on the screen are displayed in gray. The following buttons are nonfunctional under the specified conditions:

4.10: All Functions Screen

Tapping [All Functions] on the Config. screen shows the All Functions screen. The All Functions screen consists of three pages. Switch between pages using [Next >] and [< Prev.].

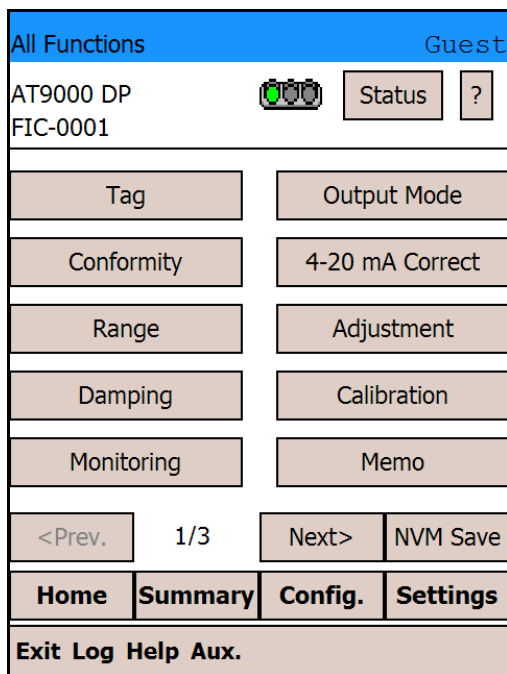

First All Functions page

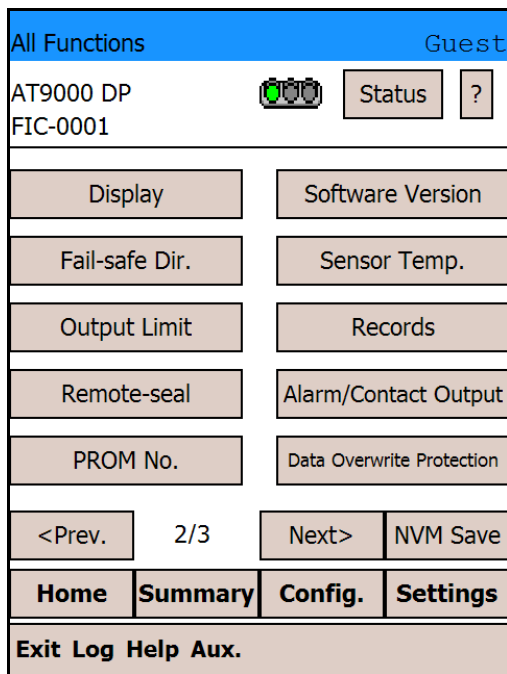

Second All Functions page

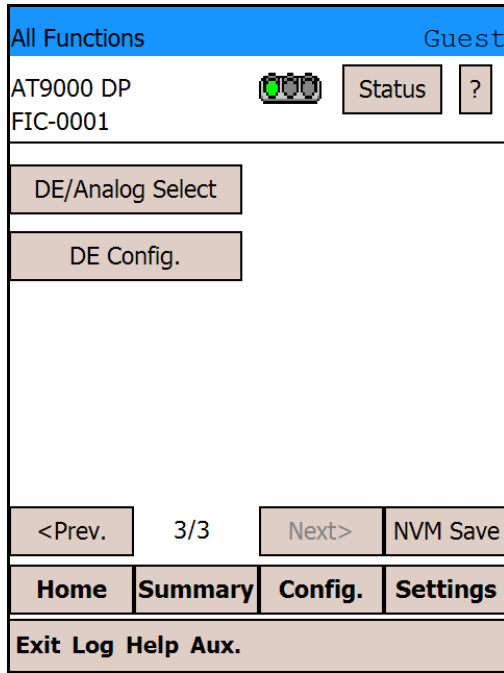

Third All Functions page

Nonfunctional buttons on the All Functions screen are displayed in gray. The following buttons are nonfunctional under the specified conditions:

[4-20 mA Correct], [Output Limit]

These functions are available in analog mode.

[Remote-seal]

Does not function if the device is not a remote-seal model.

[DE/Analog Select], [DE Config.]

These functions are available in device version 3.0 and later.

4.11: NVM Save

When you transmit changed data to the device using CommPad, the device will automatically save the data in its internal nonvolatile memory approximately 30 seconds after the transmission. If you might need to turn off the power of the device within 30 seconds after the transmission of the data, tap [NVM Save] to save the changed data immediately so that it will not be lost.

NVM Save. is available for all configuration/change operations on various data. The way to use the NVM Save. function is described below. Use [NVM Save] in the same way for various settings changes we will discuss later.

- (1) Tap [NVM Save] on the CommPad screen, and a confirmation message will appear. Tap [Yes].

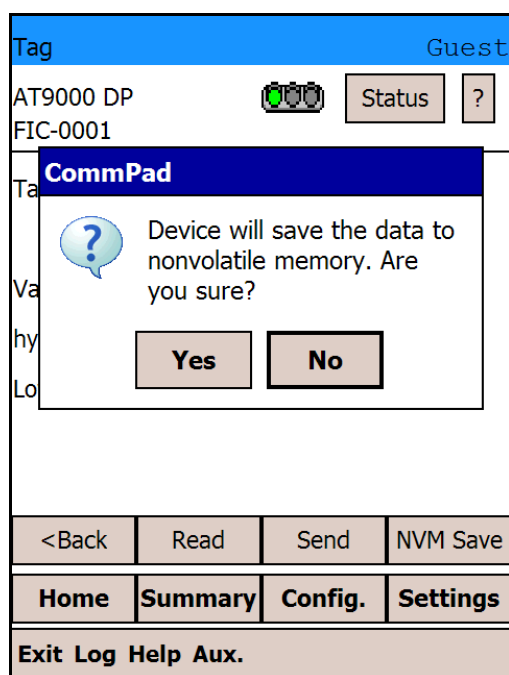

(2) When NVM Save is finished, the confirmation message appears. Tap on [ok].

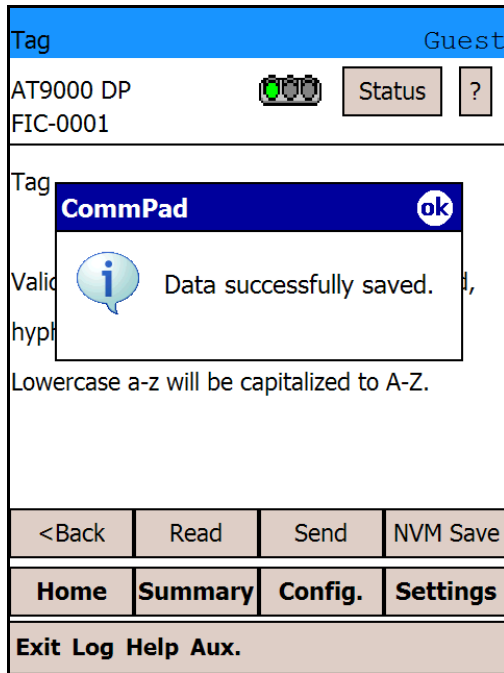

NVM Save is now done.

4.12: Tag

You can check and change a tags on this screen.

- (1) To change a tag, tap the Tag display field.

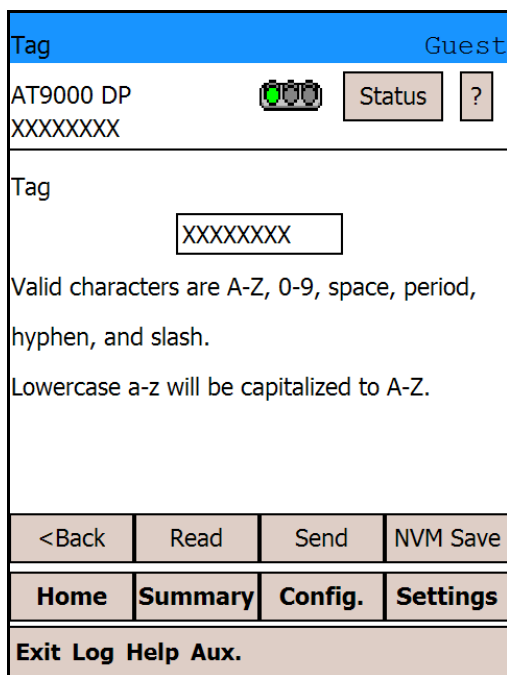

- (2) Tapping the Tag display field shows the soft keyboard. Tap [CAP] to change to uppercase character mode.

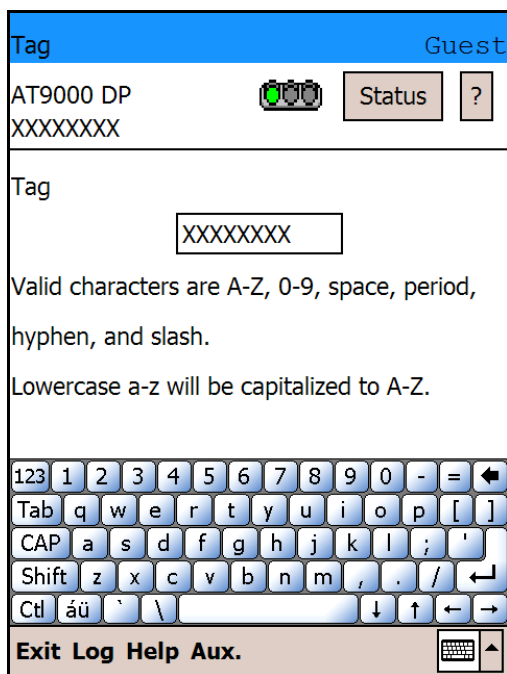

- (3) Change the tag using available characters.

Note: You may enter lowercase alphabetic characters on the soft keyboard. They will be converted to uppercase before being sent to the device.

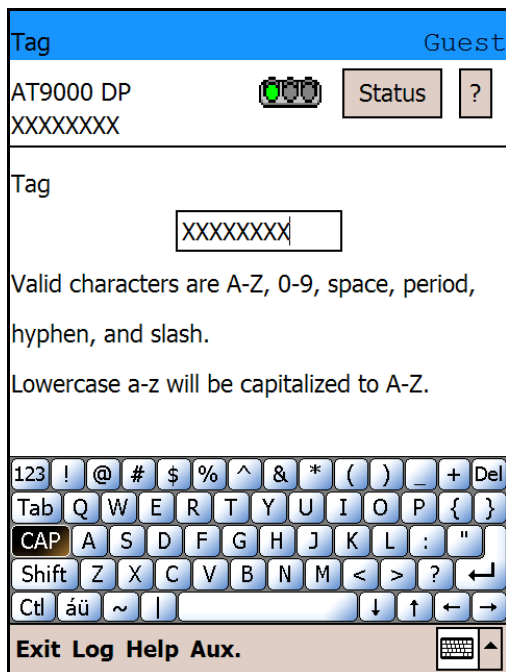

- (4) Once the tag name is confirmed, tap the return/enter key (↵). The soft keyboard will disappear from the screen.

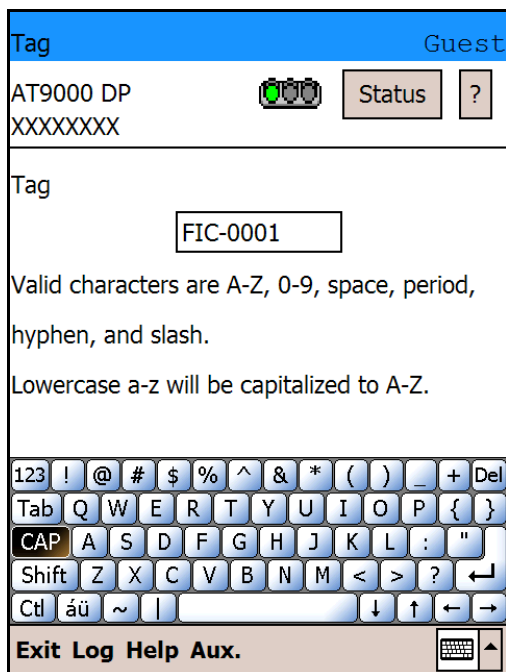

- (5) Tap [Send] to transmit the changed tag to the device.

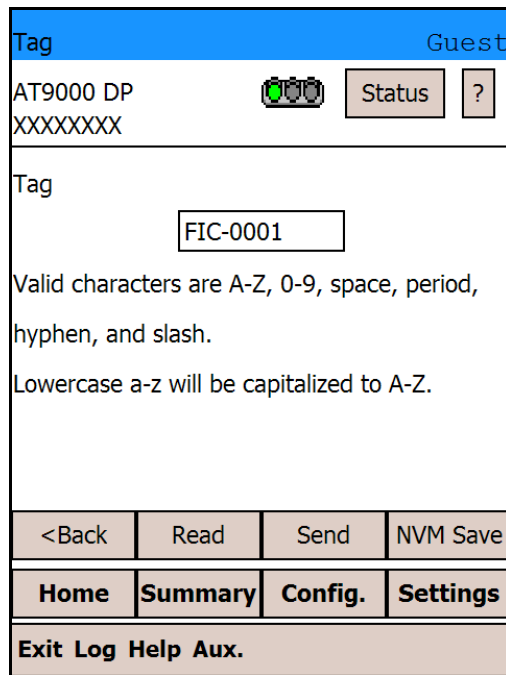

- (6) A confirmation message appears. Tap [Yes].

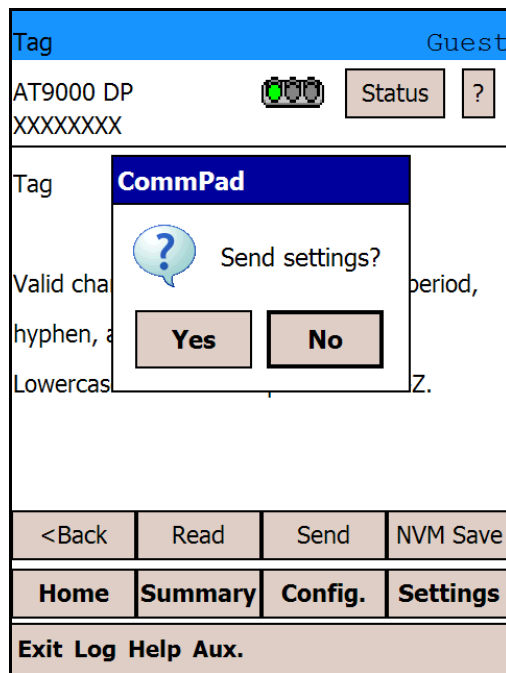

- (7) When you transmit changed data to the device, the device will save the data in its internal nonvolatile memory approximately 30 seconds after the transmission. If you might need to turn off the power of the device within 30 seconds after the transmission of the data, tap [NVM Save] to save the changed data immediately so that it will not be lost.

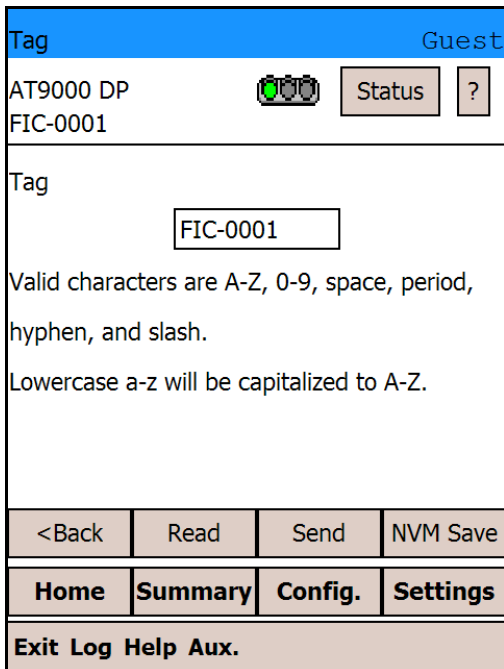

- (8) Tap [NVM Save], and a confirmation message will appear. Tap [Yes].

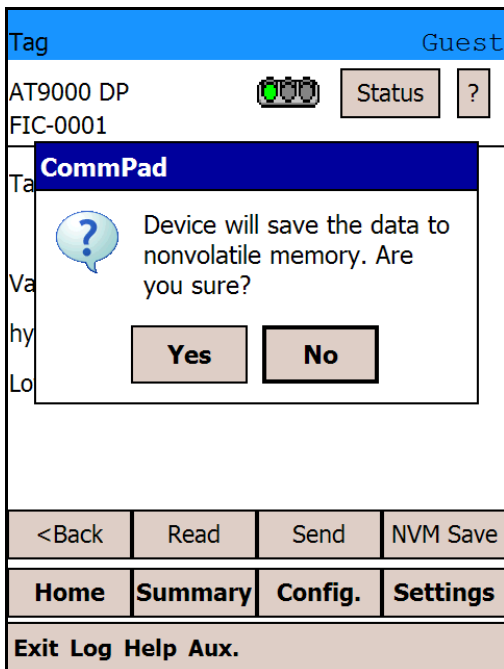

(9) When NVM Save is finished, the confirmation message appears. Tap on [ok].

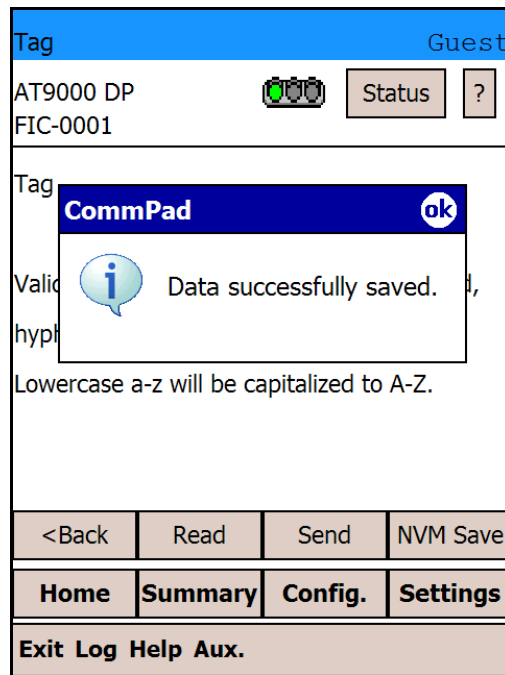

NVM Save is now done.

Each individual configuration screen basically includes [NVM Save]. If you might need to turn off the power of the device immediately after data has been changed, tap [NVM Save].

4.13: Range

You can display and change the lower and upper range values (LRV, URV) on this screen.

LRV: The pressure corresponding to 0% output (4 mA)

URV: The pressure corresponding to 100% output (20 mA)

If LRV is changed, URV will be changed automatically so that the span remains constant. To change both LRV and URV, change LRV first.

- (1) Tapping the number display field of the value you want to change shows the input screen.

Range		Guest	
AT9000 DP FIC-0001			Status ?
LRV (0%)	<input type="text" value="-10.000"/>	kPa	
URV (100%)	<input type="text" value="10.000"/>	kPa	
Span	20.00 kPa		
URL	99.64 kPa		
Read output, input			
Output	%		
Input	kPa		
<Back	Read	Send	NVM Save
Home	Summary	Config.	Settings
Exit Log Help Aux.			

- (2) Tap the input screen to enter the value. You cannot enter a value above the displayed Max. value or below the Min. value.

Range		Guest
LRV (0%)		
Min. :-149.45	Max. : 149.45	
Current : -10.000		
<input type="text"/>		
7	8	9
4	5	6
1	2	3
0	-	.
Cancel	Back Space	Enter
Exit Log Help Aux.		

(3) After entering the value, tap [Enter].

Range		Guest
LRV (0%)		
Min. :-149.45	Max. : 149.45	
Current : -10.000		
<input type="text" value="0"/>		
7	8	9
4	5	6
1	2	3
0	-	.
Cancel	Back Space	Enter
Exit Log Help Aux.		

- (4) Tap the drop-down menu for LRV (0%), and a list of alternative units will appear. If you want to change the display unit, tap the desired unit to select it.

Range		Guest
AT9000 DP FIC-0001		Status ?
LRV (0%)	<input type="text" value="-10.000"/>	kPa
URV (100%)	<input type="text" value="10.000"/>	kPa
Span	20.00	MPa
URL	99.64	Pa
		hPa
		bar
		mbar
		mmHg
		inHg
Output		
Input		kPa
<Back	Read	Send
		NVM Save
Home	Summary	Config.
		Settings
Exit Log Help Aux.		

(5) To send the changed value to the device, tap [Send].

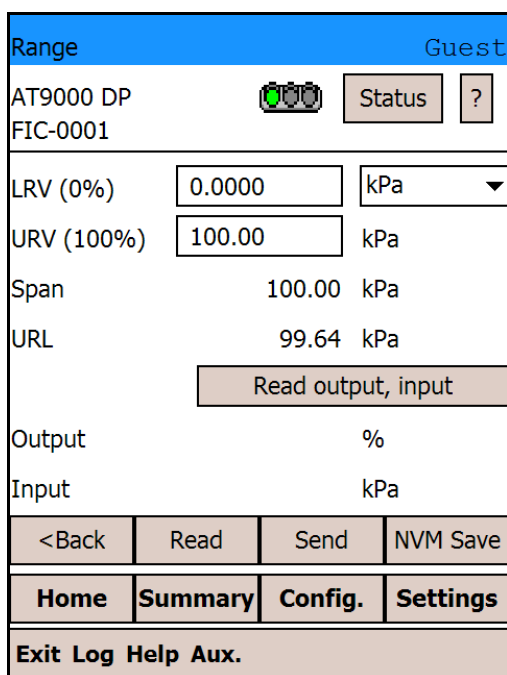

(6) A confirmation message appears. Tap [Yes].

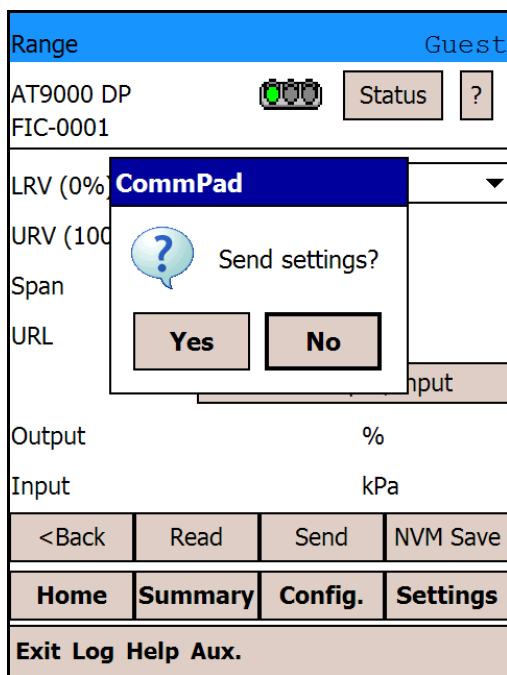

(7) If you want to see the changed output value due to the range change, tap [Yes].

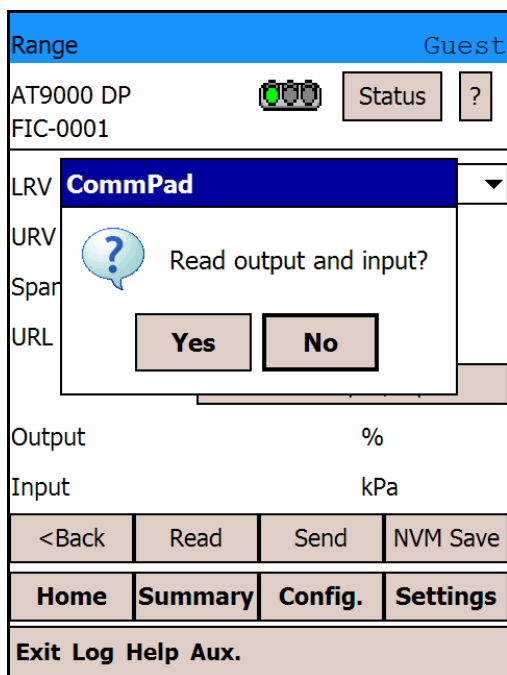

(8) The range change is now complete.

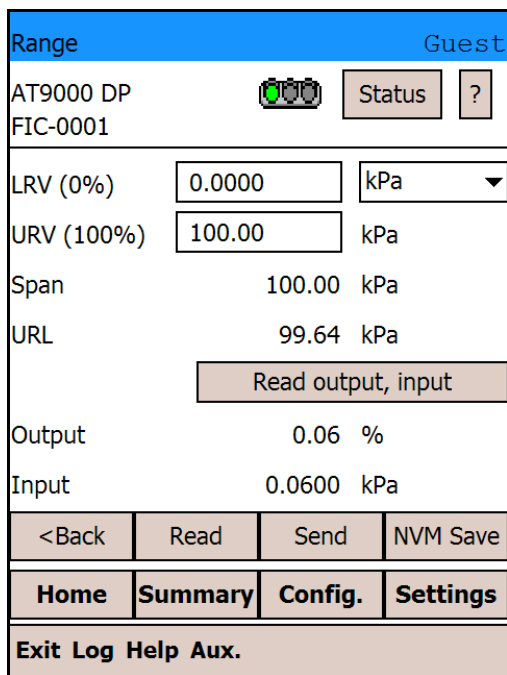

(9) Tapping [Read output, input] reads the output and input value and updates the displays. If you might need to turn off the power of the device within 30 seconds after the device of the data, tap [NVM Save] to save your changes.

4.14: Remote-seal

The items on this screen are used with a remote seal model Transmitter.

- [Auto Range (Closed Tank)]
When a remote-seal model transmitter is used to measure the liquid level in a closed tank, you can calculate the range (LRV, URV) automatically by entering high pressure flange location the specific gravity of the liquid in the tank, the type of fill fluid for the transmitter, the span, the distance between the flanges, and the distance of the zero level above the lower flange.
- [Set LRV (Actual)]
When the liquid level in a tank is given (for example, when you want to align it with a glass level gauge reading), you can adjust the range so that the given level and the transmitter output are identical.
- [Amb. Temp. Compensate]
By entering the distance between the upper flange and the lower flange of a tank, you can compensate for the effect of the fill fluid temperature in the capillary tube of the transmitter.

4.14.1 Auto Range (Closed Tank)

With the Auto Range function, you can calculate the range (LRV, URV) automatically by entering the specific gravity of the liquid in the tank, the type of fill fluid for the transmitter, the span, the distance between the flanges, and the distance of the zero level above the lower flange.

- (1) Tap [Auto Range (Closed Tank)].

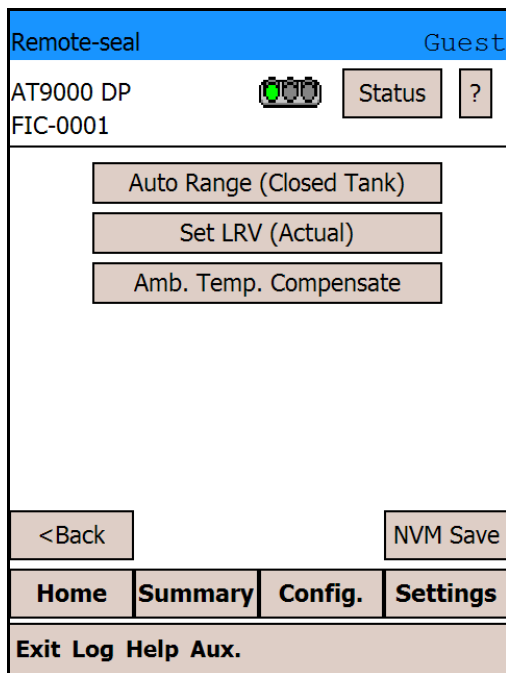

- (2) Select the mounting position and tap [Next >>].

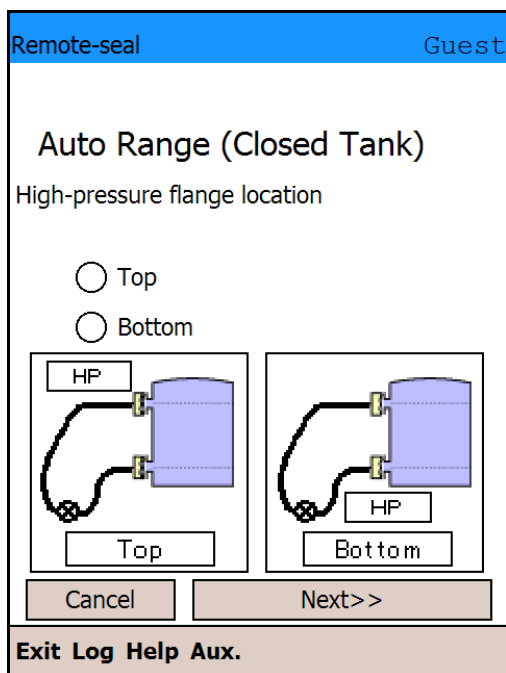

- (3) If you select “Lower Side,” this message appears: “Is the model GTX35R?” Tap [Yes] or [No] as appropriate. Please tap “No” if the model is not GTR35R.

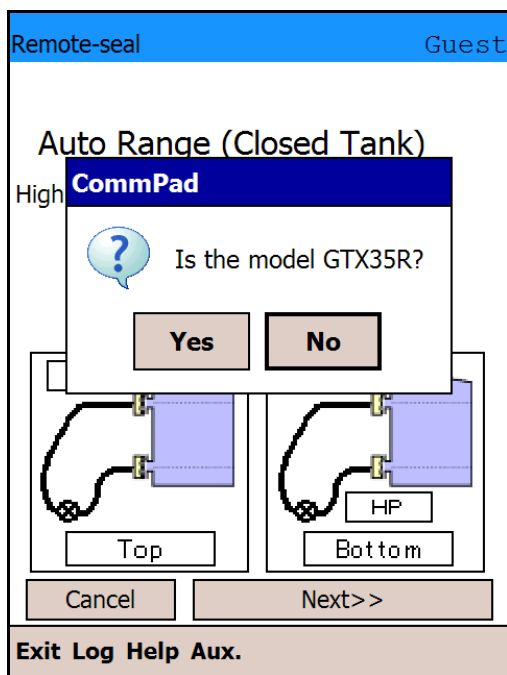

- (4) If your Transmitter is not GTX35R, you cannot mount the high pressure side flange at the bottom of the tank. To continue the configuration, tap [Yes].

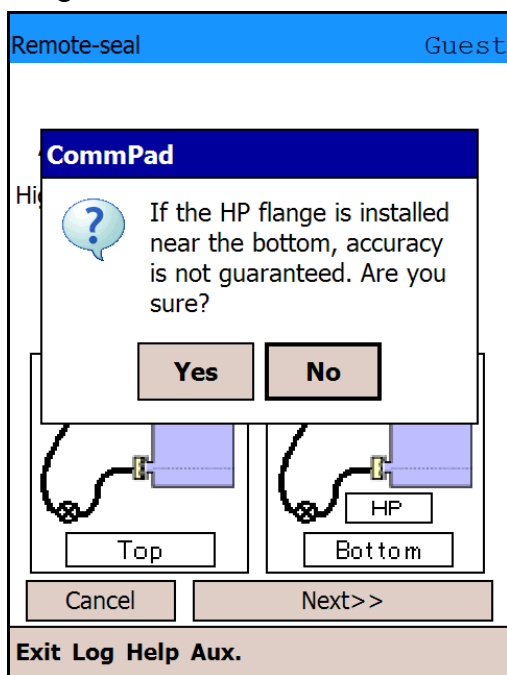

- (5) The screen for entering the specific gravity (ρ) appears. Tap the number display field for ρ .

The screenshot shows a mobile application interface. At the top, there is a blue header bar with 'Remote-seal' on the left and 'Guest' on the right. Below the header, the title 'Auto Range (Closed Tank)' is displayed. Underneath the title, the text 'Specific Gravity (ρ)' is shown. A small ρ symbol is positioned to the left of a rectangular input field. At the bottom of the screen, there are two buttons: 'Cancel' on the left and 'Next>>' on the right. A footer bar at the very bottom contains the text 'Exit Log Help Aux.'.

- (6) The input screen for the specific gravity appears. Enter the specific gravity and tap [Enter]

The screenshot shows the same application interface as in step (5), but now with a numeric keypad displayed below the input field. The keypad consists of a grid of buttons. At the top, there is a blue header bar with 'Remote-seal' on the left and 'Guest' on the right. Below the header, the text 'Specific Gravity' is shown. A rectangular input field is positioned above the keypad. The keypad buttons are arranged as follows:

7	8	9
4	5	6
1	2	3
0	-	.
Cancel	Back Space	Enter

 At the bottom of the screen, there is a footer bar with the text 'Exit Log Help Aux.'.

(7) After entering the value for ρ , tap [Next >>].

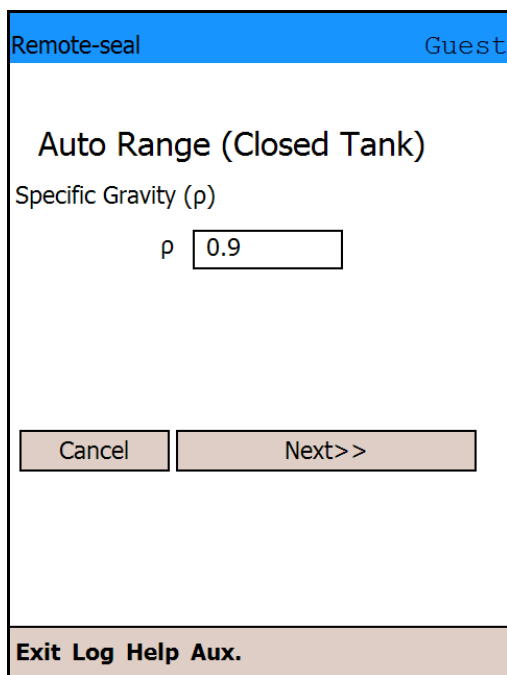

(8) The screen for selecting a fill fluid appears. Tap the fill fluid drop-down menu and select a type of fill fluid from the list. After selecting the type, tap [Next >>].

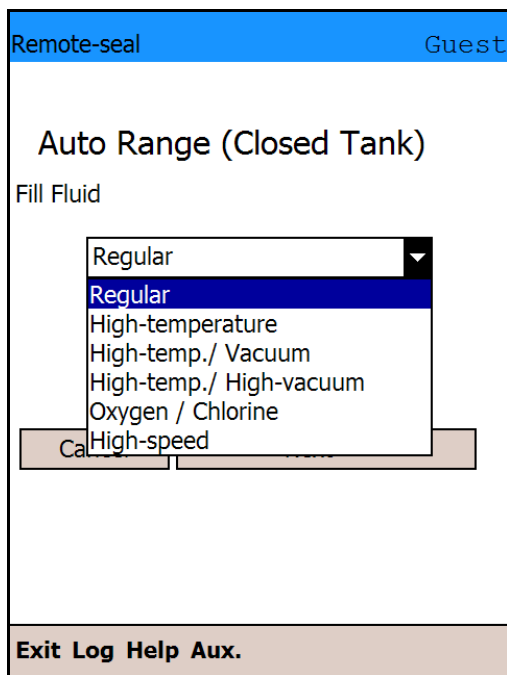

(9) Next, enter the span (λ), and tap [Next >>].

The screenshot shows a mobile application interface. At the top, there is a blue header bar with 'Remote-seal' on the left and 'Guest' on the right. Below the header, the title 'Auto Range (Closed Tank)' is centered. Underneath the title, the text 'Span (λ)' is displayed. Below this, there is a label ' λ ' followed by a rectangular input field and the unit 'mm'. At the bottom of the screen, there are two buttons: 'Cancel' on the left and 'Next>>' on the right. A footer bar at the very bottom contains the text 'Exit Log Help Aux.'.

(10) Enter the distance (d) between the flanges, and tap [Next>>].

The screenshot shows a mobile application interface. At the top, there is a blue header bar with 'Remote-seal' on the left and 'Guest' on the right. Below the header, the title 'Auto Range (Closed Tank)' is centered. Underneath the title, the text 'Flange Span (d)' is displayed. Below this, there is a label 'd' followed by a rectangular input field and the unit 'mm'. Below the input field, there is a button labeled 'Flange Span Auto Calculation'. At the bottom of the screen, there are two buttons: 'Cancel' on the left and 'Next>>' on the right. A footer bar at the very bottom contains the text 'Exit Log Help Aux.'.

Automatic Calculation of Flange Span

When the tank is empty, the distance between the flanges can be calculated automatically. However, note that the calculated value may be different from the actual value due to mounting error. Use this value only as a guide.

Tap [Flange Span Auto Calculation]. Make sure that the tank is empty, and tap [Yes].

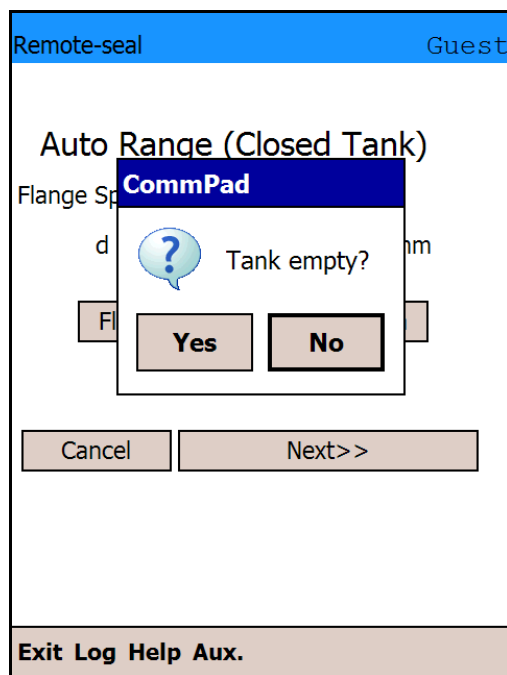

The approximate distance between the flanges will be calculated based on the current input values and the density of the fill fluid. If the value is acceptable, tap [Next>>].

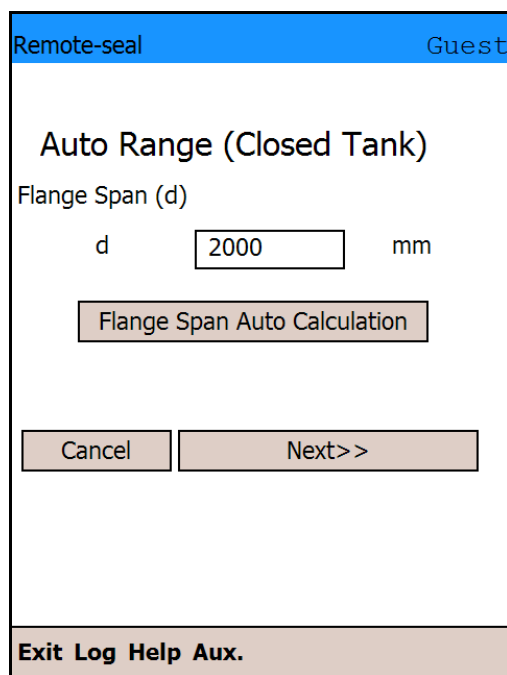

- (11) Enter the distance between 0% liquid level and the lower flange, and tap [Next>>]. If 0% liquid level will come above the lower flange, enter a positive number. Otherwise, enter a negative number.

Remote-seal Guest

Auto Range (Closed Tank)

Distance of zero level above lower flange

h mm

Cancel Next>>

Exit Log Help Aux.

- (12) The range calculated from the input values is displayed. If the value is acceptable, tap [Send].

Remote-seal Guest

Auto Range (Closed Tank)

HP Flange Top

ρ 0.9

Fill Fluid Regular

λ 1500 mm

d 2000 mm

h 250 mm

Calculated Range

LRV (0%) 16.132 kPa ▼

URV (100%) 2.893 kPa

Cancel Send

Exit Log Help Aux.

(13) A confirmation message appears. Tap [Yes].

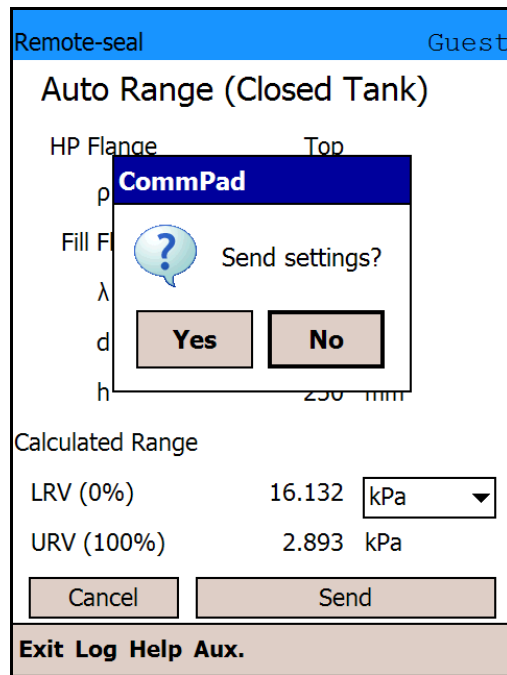

(14) The remote-seal auto range process is now complete. If you might need to turn off the power of the transmitter within 30 seconds after the transmission of the data, tap [NVM Save] to save your changes.

4.14.2 Set LRV (Actual)

If you want to configure the range by setting a certain output percentage as the current liquid level in the tank, use the Set LRV (Actual) function.

- (1) Tap [Set LRV (Actual)].

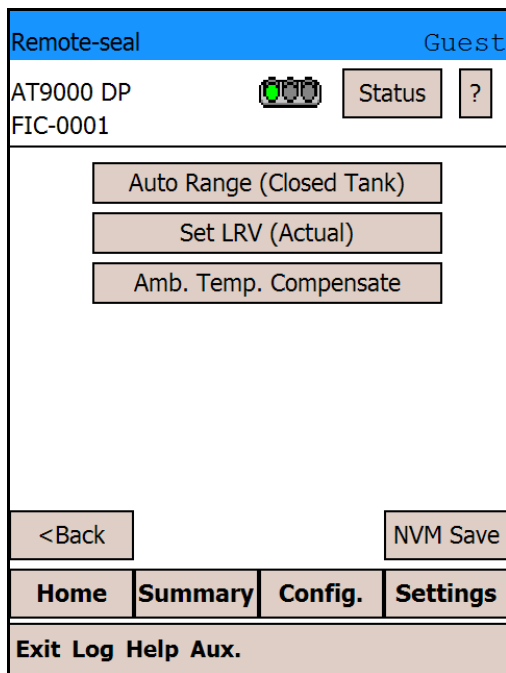

- (2) Tap the number display field for Target, enter the desired output value, and then tap [Set].

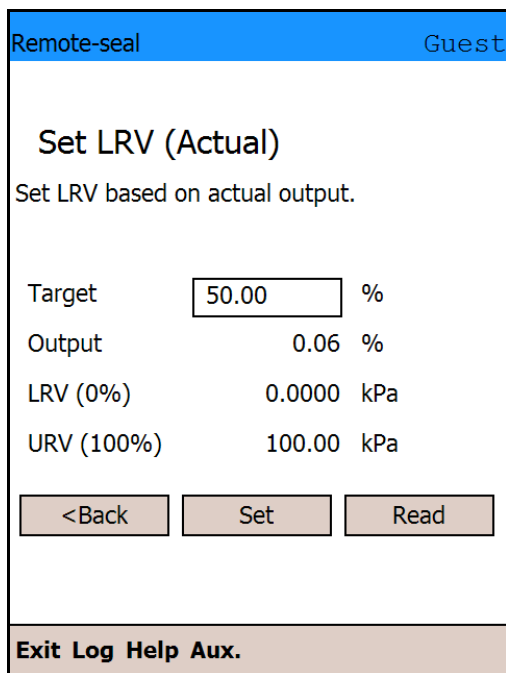

- (3) A confirmation message appears. Tap [Yes].

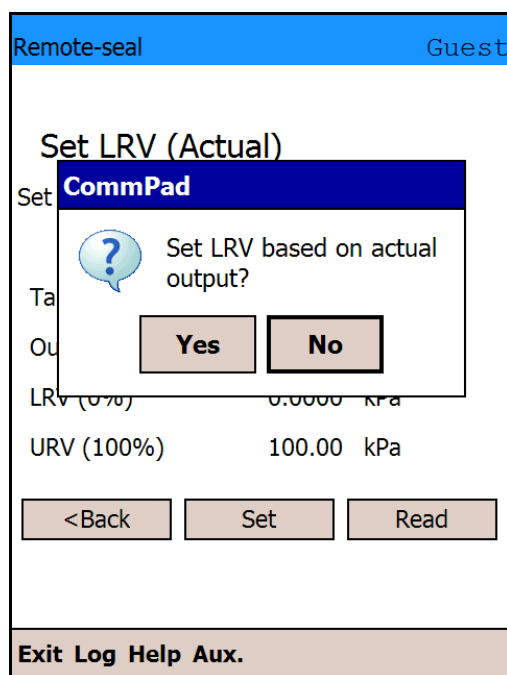

The range changes, and the Output value becomes identical to that of Target.

Tap [Read] to reread and redisplay the Output and range values.

- (4) Tap [< Back] to return to the Remote-seal screen.

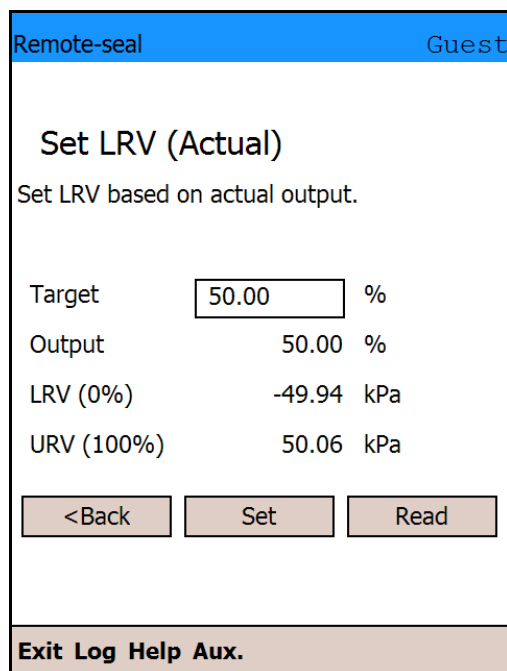

- (5) LRV (Actual) is now set. If you might need to turn off the power of the transmitter within 30 seconds after the transmission of the data, tap [NVM Save]. to save your changes.

4.14.3 Amb. Temp. Compensate

With the Amb. Temp. Compensate function, you can compensate for the measurement error due to the density change of the fill fluid, which is caused by the ambient temperature change. There are two ways to perform Amb. Temp. Compensate: when the distance between the flanges is known and when the distance between the flanges is unknown.

- When the Distance Between the Flanges Is Known

(1) Tap [Amb. Temp. Compensate].

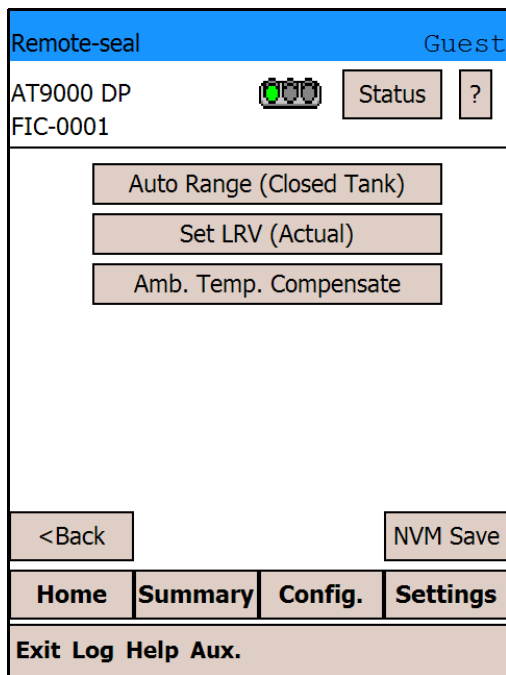

(2) The screen for entering the Flange Span appears. Tap the number display field for the Height.

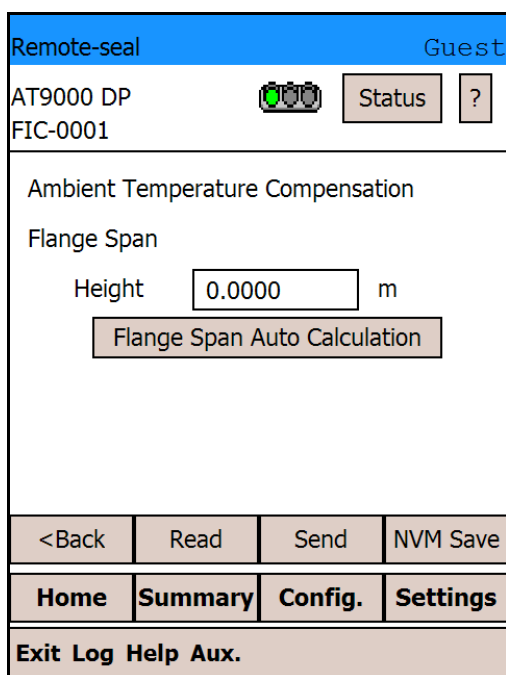

- (3) Enter the distance between the flanges and tap [Enter]. If the high pressure side flange is positioned higher, enter a positive number.

Remote-seal		Guest
Height		
Min.	: -30.00	Max. : 30.00
Current : 0.0000		
<input type="text"/>		
7	8	9
4	5	6
1	2	3
0	-	.
Cancel	Back Space	Enter
Exit Log Help Aux.		

- (4) If a positive number is entered, the message shown below appears. If the mounting of the flanges is correct, tap [Yes].

Remote-seal		Guest						
Height								
Min.	: -30.00	Max. : 30.00						
Cur	5							
<table border="1"> <tr> <td colspan="2">CommPad</td> </tr> <tr> <td></td> <td>Is the HP flange attached above the LP?</td> </tr> <tr> <td>Yes</td> <td>No</td> </tr> </table>			CommPad			Is the HP flange attached above the LP?	Yes	No
CommPad								
	Is the HP flange attached above the LP?							
Yes	No							
1	2	3						
0	-	.						
Cancel	Back Space	Enter						
Exit Log Help Aux.								

Otherwise, tap [No] and then [OK], and enter a negative number for the distance between the flanges.

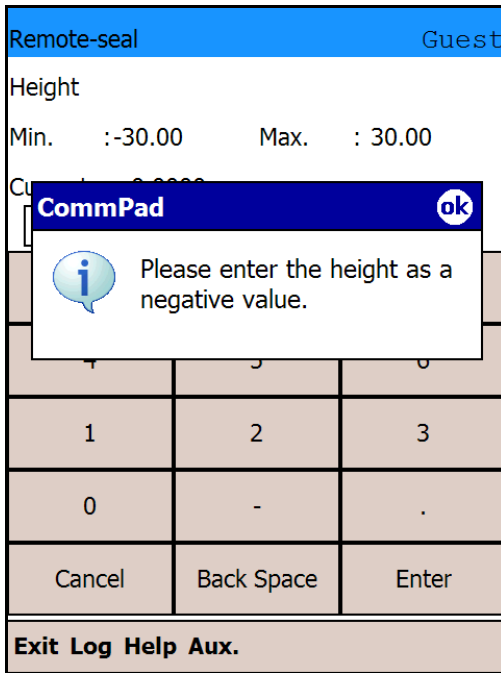

- (5) If a negative number is entered, the message shown below appears. If the mounting of the flanges is correct, tap [Yes].

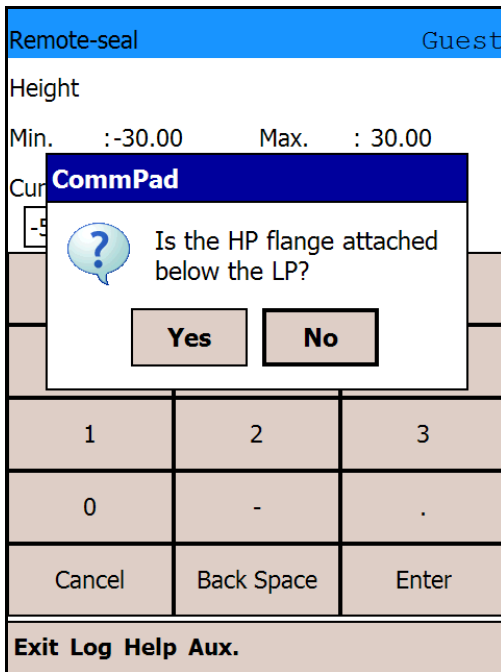

Otherwise, tap [No] and then [OK], and enter a positive number for the distance between the flanges.

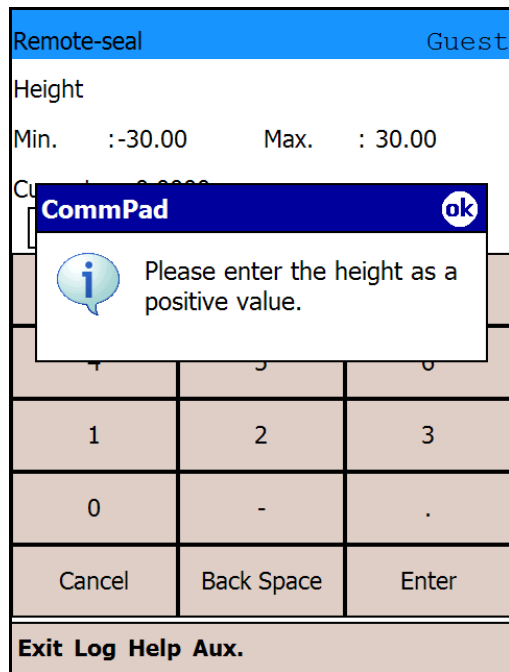

(6) After entering the distance between the flanges, tap [Send].

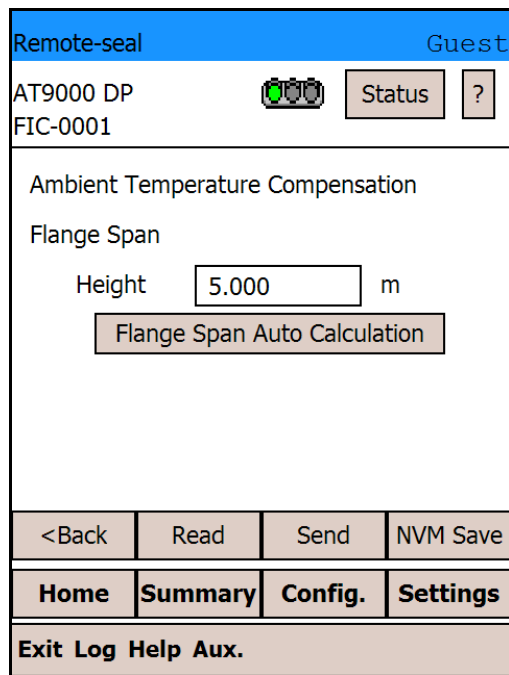

(7) A confirmation message appears. Tap [Yes].

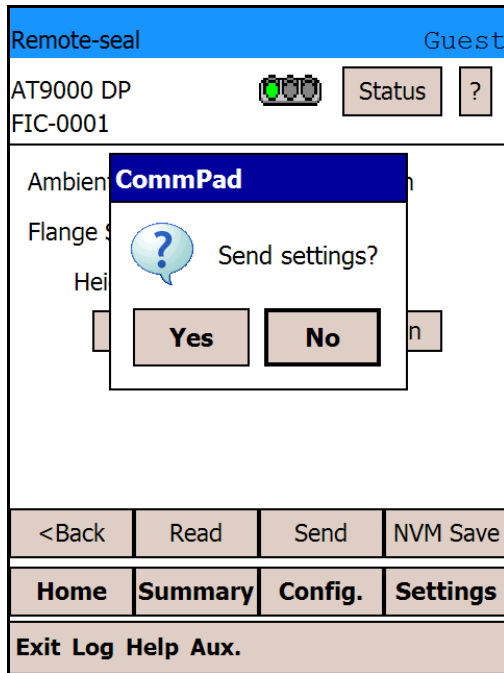

(8) The ambient temperature compensation configuration is now complete. If you might need to turn off the power of the transmitter within 30 seconds after the transmission of the data, tap [NVM Save] to save your changes.

- When the Distance Between the Flanges Is Unknown
When the distance between the flanges is unknown, the approximate distance can be configured automatically.

(1) Tap [Amb. Temp. Compensate].

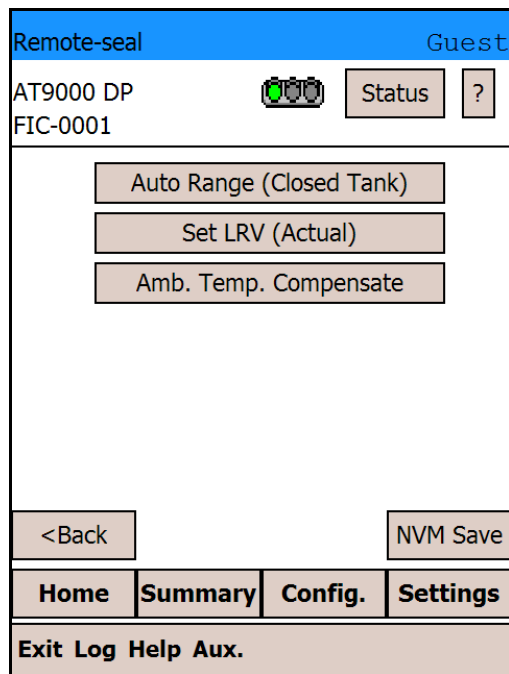

(2) Tap [Flange Span Auto Calculation].

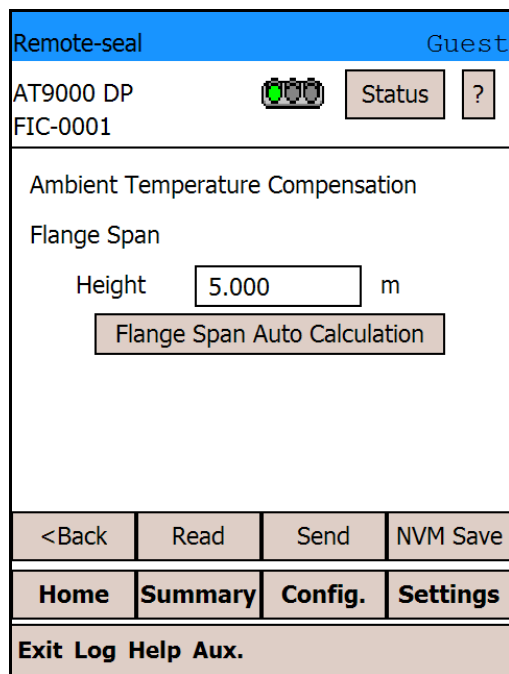

(3) Select a type of fill fluid and tap [OK].

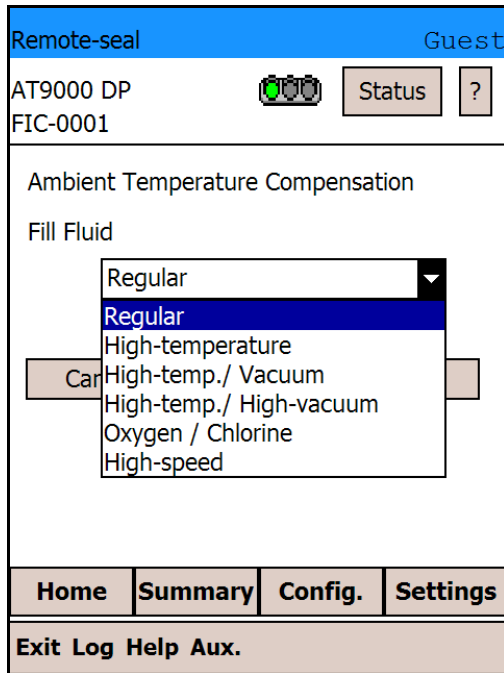

(4) The confirmation message appears. Make sure that the tank is empty, and Tap [Yes].

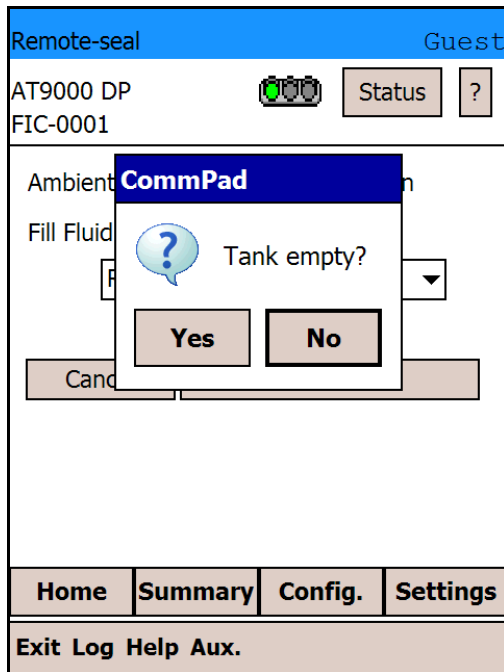

- (5) The calculated distance between the flanges is displayed. If the value is acceptable, tap [Send].

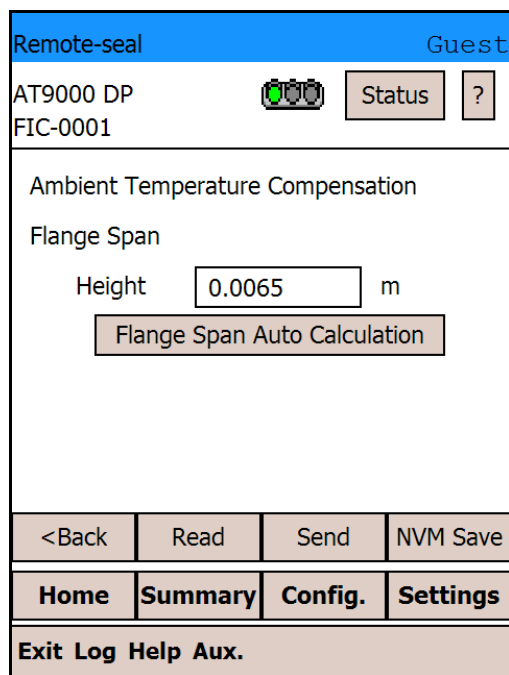

- (6) A confirmation message appears. Tap [Yes].

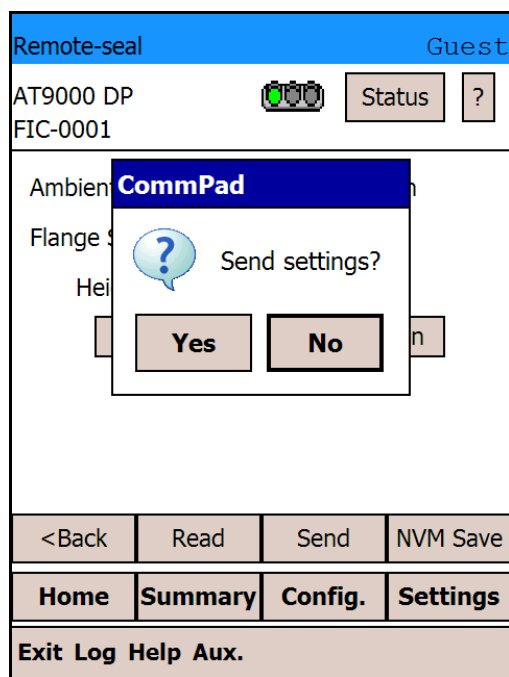

- (7) The ambient temperature compensation configuration is now complete. If you might need to turn off the power of the transmitter within 30 seconds after the transmission of the data, tap [NVM Save] to save your changes.

4.15: Display

On this screen you can configure display format (linear or square root) and display unit (% , actual pressure, or engineering unit) for the device indicator. If you select engineering units for display, the following values need to be specified:

EULO: The value displayed on the indicator when the output of the device is 0%

EUHI: The value displayed on the indicator when the output of the device is 100%

“Actual Pressure” displays the actual measurement value in the selected pressure unit.

“Engineering Unit” displays the flow rate, level, or other values in the specified scale or unit.

You can also select “Engineering Unit” or the unit that the user defined arbitrarily for display.

- (1) To change the settings, tap [Modify settings].

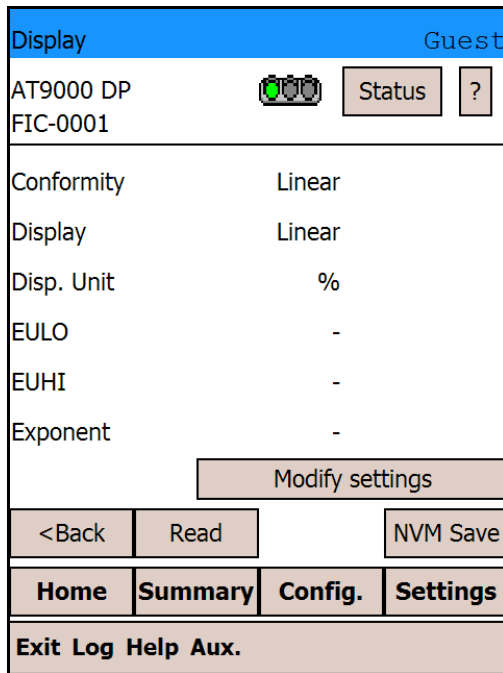

- (2) Select unit mode. After selecting a unit mode, tap [Next>>].
If “Actual Pressure” is selected, or% is selected when the “Conformity” is square root, the Send screen will appear.
If% or “Actual Pressure” is selected when “Conformity” is linear, the screen to configure the display format will appear.
If “Engineering Unit” is selected when “Conformity” is square root, the screen to configure EULO and EUHI, the lower and upper limits for the engineering unit, will appear.

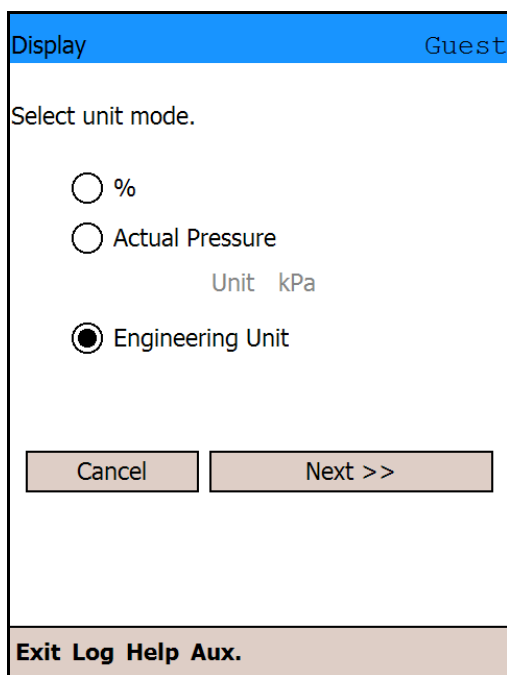

- (3) Select the display conformity. “Square Root (flow Rate)” changes the display to square root (flow rate) when the Conformity is linear. After selecting a display format, tap [Next>>].

If selected unit mode is%, the send screen will appear.

If selected unit mode is “Engineering Unit”, the screen to configure EULO and EUHI, the lower and upper limits for the engineering unit, will appear.

The screenshot shows a mobile application interface titled "Display" with a user name "Guest" in the top right corner. The main content area is titled "Select display conformity." and contains two radio button options: "Linear" (which is selected) and "Square Root (Flow Rate)". At the bottom of the screen, there are two buttons: "Cancel" and "Next >>". A footer bar at the very bottom contains the text "Exit Log Help Aux.".

- (4) Configure Engineering Unit. If you configure “User-defined Unit”, tap the drop-down menu for “Unit” and select “User define unit”. After selecting, tap [Next>>].

The screenshot shows a mobile application interface titled "Display" with a user name "Guest" in the top right corner. The main content area is titled "Engineering Unit" and contains several configuration fields: "EULO" with a text input field containing "0.0000" and "kPa" to its right; "EUHI" with a text input field containing "100.00" and "kPa" to its right; "Exponent" with a dropdown menu showing "x10"; "Unit" with a dropdown menu showing "kPa"; and "User-defined Unit" with a text input field containing "mAq". At the bottom of the screen, there are two buttons: "Cancel" and "Next >>". A footer bar at the very bottom contains the text "Exit Log Help Aux.".

- (5) Check the displayed values and tap [Send].

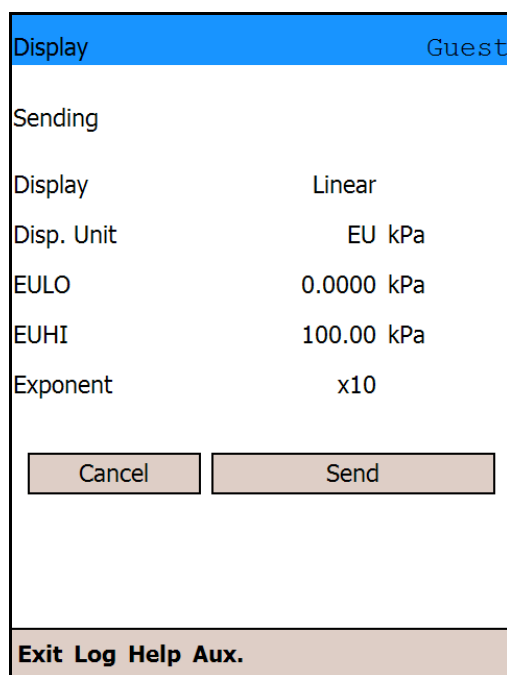

- (6) The confirmation message for transmission appears. Tap [Yes]. When the transmission is completed, the initial Display screen appears again.

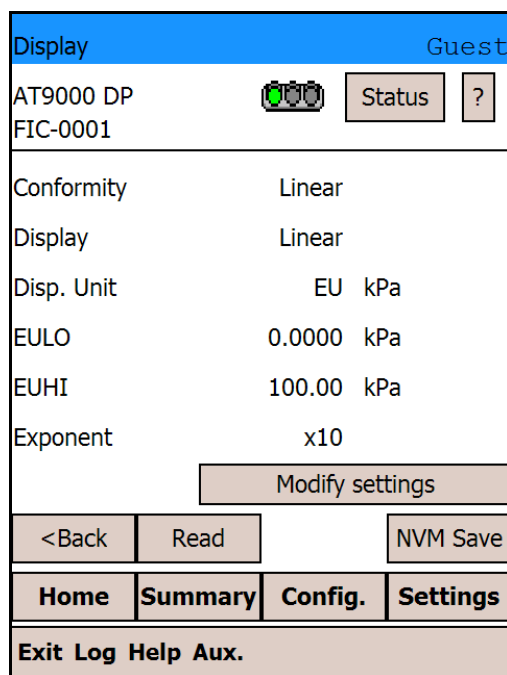

Indicator configuration is now complete. If you might need to turn off the power of the device within 30 seconds after the transmission of the data, tap [NVM Save] to save your changes. Tapping [Read] reads the set values and displays them again. Tapping [<Back] restores the original screen.

4.16: Damping

You can configure the damping time constant on this screen. Allowable values (in seconds) are: 0.0, 0.16, 0.32, 0.48, 1.0, 2.0, 4.0, 8.0, 16.0, and 32.0.

The current value is displayed.

- (1) Tap the “Damping” drop-down menu, and a list of alternative damping time constants will appear. Select the desired value and tap [Send].

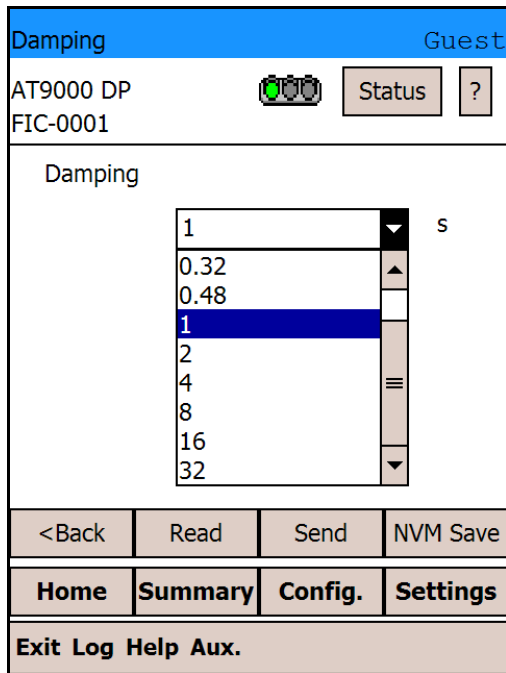

Damping time configuration is now complete. If you might need to turn off the power of the device within 30 seconds after the transmission of the data, tap [NVM Save] to save your change. Tapping [Read] reads the set values and displays them again. Tapping [<Back] restores the original screen.

4.17: Conformity

On this screen you can configure the following four items related to conformity:

- **Conformity**
Select either linear or square root conformity.
- **Cutoff**
Cuts the output off when the flow rate is low. Set the cutoff threshold value.
- **Dropout**
Select either zero or linear output when the output is cut off.
- **Flow Mode**
Select either square root extraction in the forward direction only, or in both directions.

(1) To change the settings, tap [Modify settings].

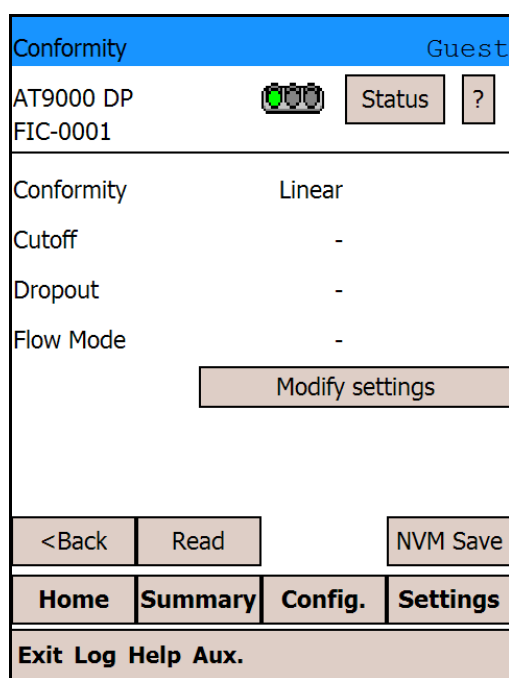

- (2) Select either “Linear” or “Square Root” and tap [Next>>].

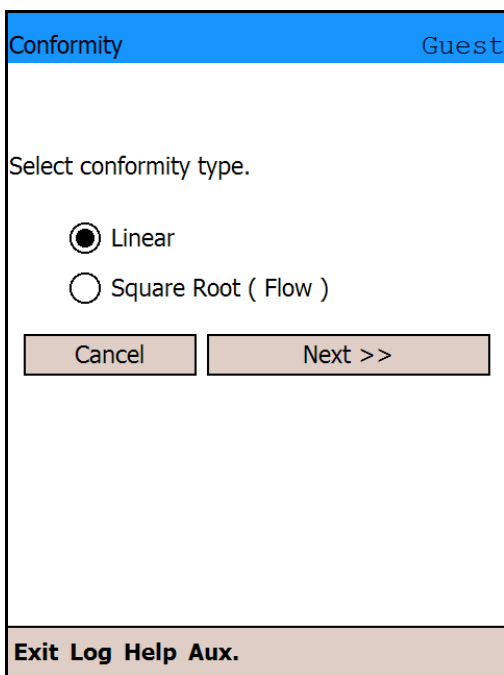

- (3) If you select square root conformity, a screen for selection of low flow cutoff appears. Select either “default 7.1%” or “Custom value(0- 20%)” which allows the choice of any value between 0% and 20%.

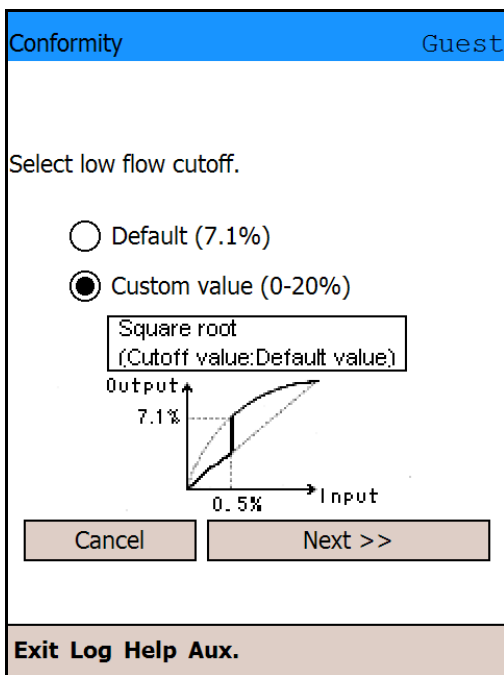

- (4) If you select “Custom value” the input screen for entry of the cutoff value appears. Enter a value between 0 and 20 and tap [Enter].

Conformity		Guest
Cutoff		
Min.	:0.00	Max. :20.00
<input type="text" value="10"/>		
7	8	9
4	5	6
1	2	3
0	-	.
Cancel	Back Space	Enter
Exit Log Help Aux.		

- (5) Next, select a dropout format (linear or zero), and tap [Next>>].

Conformity		Guest
Select dropout.		
<input checked="" type="radio"/> Linear <input type="radio"/> Zero		
<input type="text" value="Dropout linear"/>		<input type="text" value="Dropout zero"/>
<input type="text" value="Cancel"/>	<input type="text" value="Next >>"/>	
Exit Log Help Aux.		

(6) Finally, select a flow mode. Normally, you should choose “Default.”

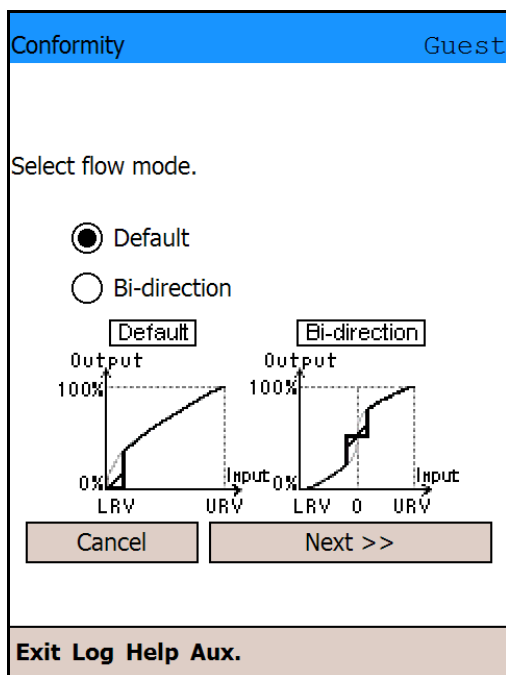

(7) The transmission screen appears. Check the values, and tap [Send].

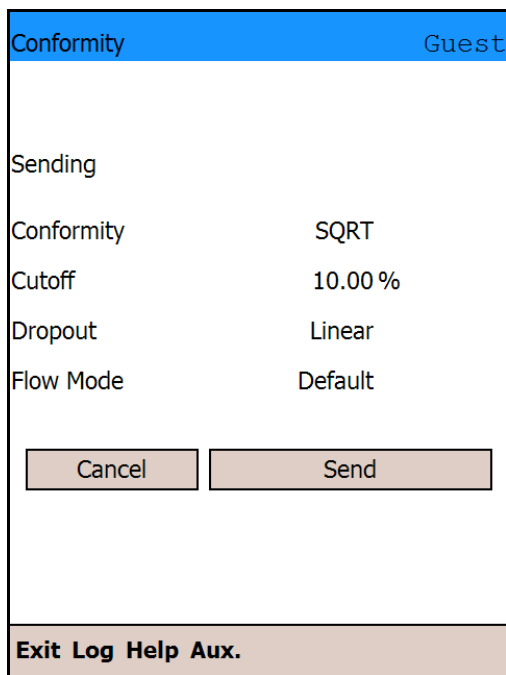

The confirmation message for transmission appears. Tap Yes.

(8) When the transmission is completed, the initial screen appears again.

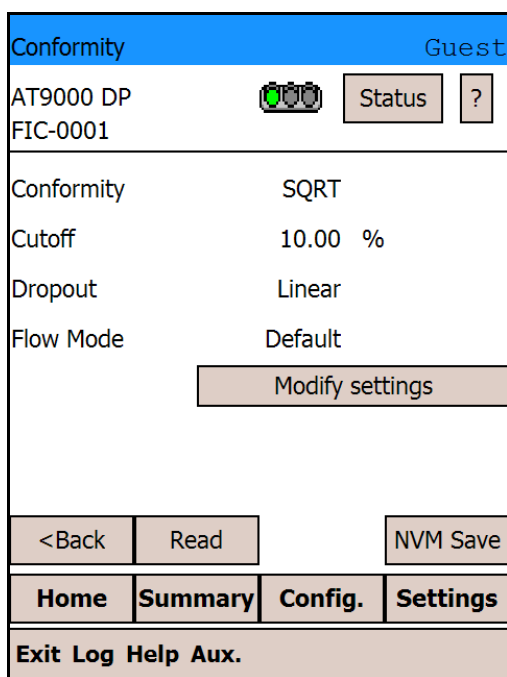

The configurations for conformity are now complete. If you might need to turn off the power of the device within 30 seconds after the transmission of the data, tap [NVM Save] to save your changes. Tapping [Read] reads the set values and displays them again. Tapping [<Back] restores the original screen.

4.18: Checking the Fail-safe Direction

This screen shows the output behavior if a critical failure occurs.

- Upscale: Output at upper limit.
- Downscale: Output at lower limit.

You cannot change the Up/Down setting.

The output standard is also displayed.

- NAMUR NE43-compliant: 21 mA or higher (Up)/3.6 mA or lower (Down)
- Non-NAMUR NE43-compliant: 21.6 mA or higher (Up)/3.6 mA or lower (Down)

Burnout Simulation

- (1) You can simulate the output of a critical failure.

By tapping [Set], the device enters Simulation mode and the output goes beyond the upper or lower limit.

To clear this mode, tap [Clear].

If DE output has been selected, MANUR NE43-compliant is not available, and Failure Alarm-Simulation Mode cannot be used.

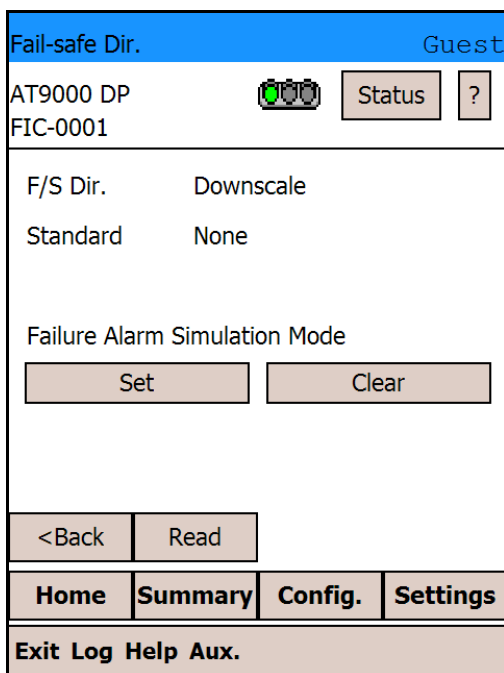

Analog Mode

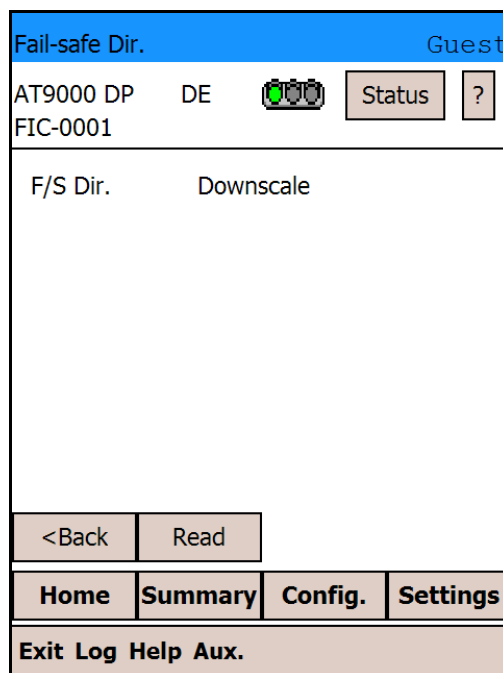

DE Mode

- (2) To run a simulation of the occurrence of a burnout, tap the [Set] button. A confirmation message appears. Tap [Yes].

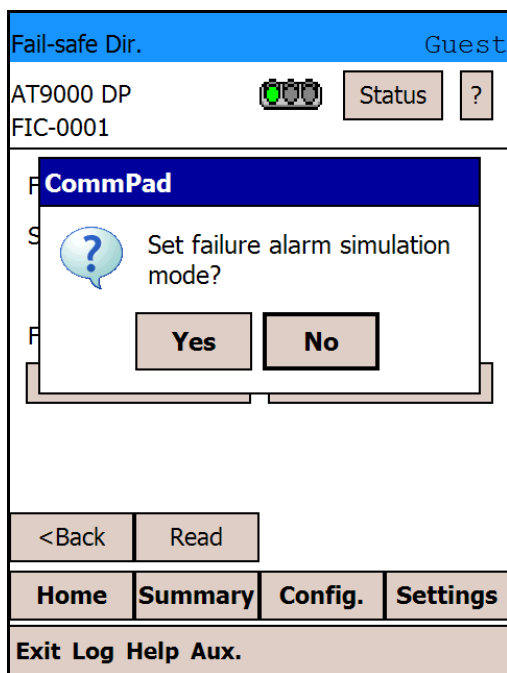

- (3) The device is now in the Burnout Simulation state, and the traffic light icon changes to yellow.

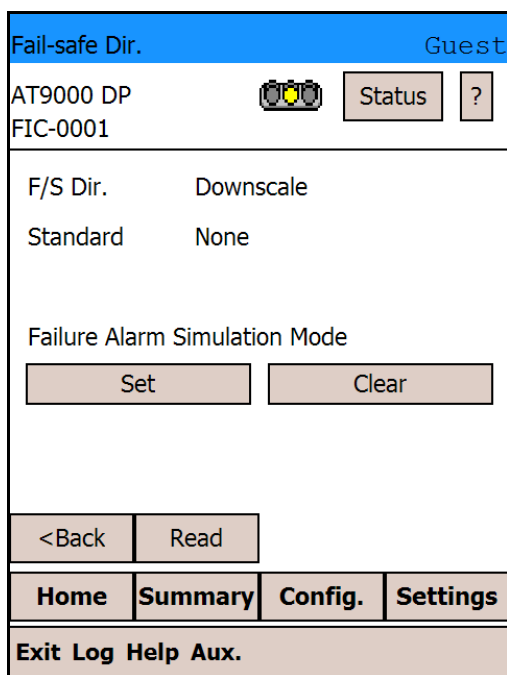

- (4) To clear the Burnout Simulation, tap [Clear].
A confirmation message appears. Tap [Yes].

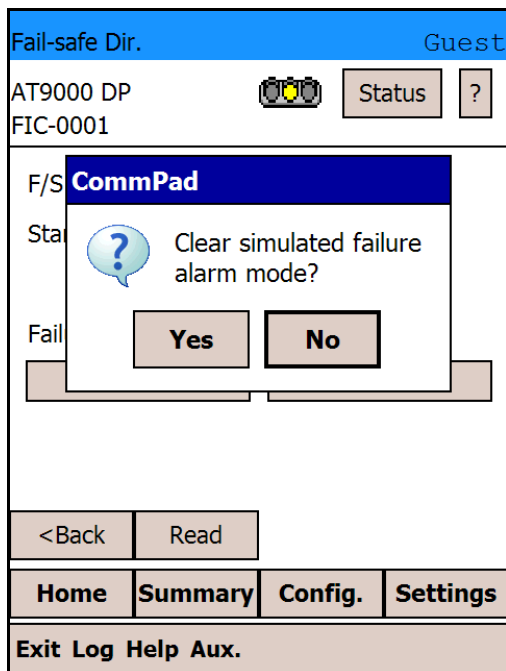

The Burnout Simulation is now cleared. Note that even if you do not clear the Burnout Simulation, the device will automatically clear it after approximately 10 minutes without communication.

- (5) If you try to go to another screen from the Burnout Direction screen without first clearing the Burnout Simulation, the confirmation message “Clearing simulated failure alarm mode and proceeding to the specified screen.” appears. Tap [OK], and the Burnout Simulation is cleared and you will go to the other screen.

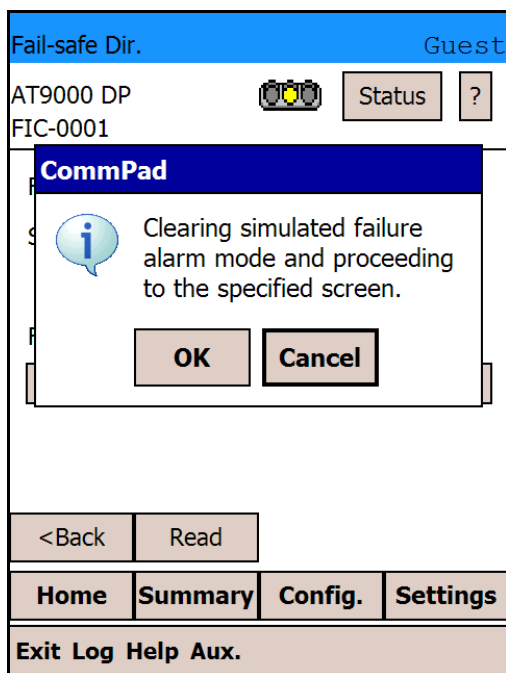

Tapping [Read] reads the set values and displays them again. Tapping [<Back] restores the original screen.

4.19: Output Limit

You can set the maximum and minimum output limits on this screen. The output will remain between the maximum and minimum values unless a burnout occurs.

You cannot change output limits if the analog output level is compliant with NAMUR NE43.

<If the analog output level is compliant with NAMUR NE 43>

Output Limit		Guest	
AT9000 DP FIC-0001		Status	?
Low Limit	<input type="text" value="-1.2500"/>	%	
High Limit	<input type="text" value="103.13"/>	%	
<Back	Read	Send	NVM Save
Home	Summary	Config.	Settings
Exit Log Help Aux.			

<If the analog output level is not compliant with NAMUR NE 43>

- (1) To change the minimum output, tap the “Low Limit” display field.

Output Limit		Guest	
AT9000 DP FIC-0001		Status	?
Low Limit	<input type="text" value="-2.500"/>	%	
High Limit	<input type="text" value="110.00"/>	%	
<Back	Read	Send	NVM Save
Home	Summary	Config.	Settings
Exit Log Help Aux.			

- (2) The input screen for the minimum output appears. Enter a value you want to set, and tap [Enter].

Output Limit		Guest
Low Limit		
Min.	: -2.500	Max. : 49.99
Current : -2.500		
<input type="text" value="0"/>		
7	8	9
4	5	6
1	2	3
0	-	.
Cancel	Back Space	Enter
Exit Log Help Aux.		

- (3) Similarly, enter a value you want to set for the maximum output, and tap [Enter].

Output Limit		Guest
High Limit		
Min.	: 50.00	Max. : 110.00
Current : 110.00		
<input type="text" value="100"/>		
7	8	9
4	5	6
1	2	3
0	-	.
Cancel	Back Space	Enter
Exit Log Help Aux.		

(4) The values you have set appear. Tap [Send].

Output Limit		Guest	
AT9000 DP FIC-0001		Status	?
Low Limit	<input type="text" value="0.0000"/>	%	
High Limit	<input type="text" value="100.00"/>	%	
<Back	Read	Send	NVM Save
Home	Summary	Config.	Settings
Exit Log Help Aux.			

Output limit configuration is now complete. If you might need to turn off the power of the device within 30 seconds after the transmission of the data, tap [NVM Save] to save your changes. Tapping [Read] reads the set values and displays them again. Tapping [<Back] restores the original screen.

4.20: Memo

You can display and write to the built-in device Memo fields on this screen. You may enter up to 16 one-byte alphanumeric characters each in Memo 1 and Memo 2.

- (1) Tapping either the “Memo 1” or “Memo 2” display field shows the soft keyboard.

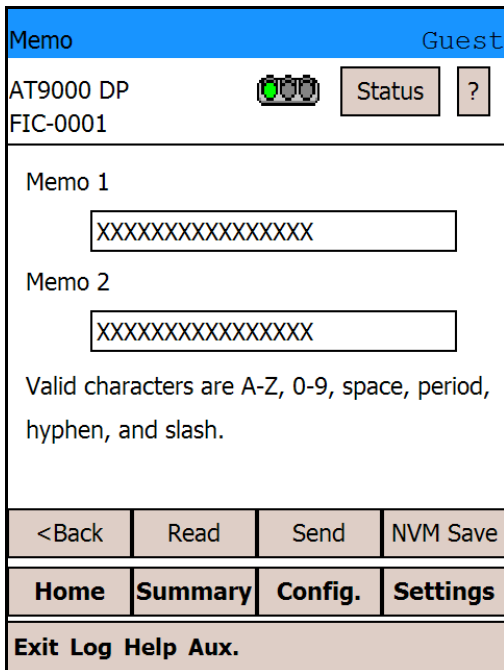

- (2) Tap [CAP] to change to uppercase character mode.

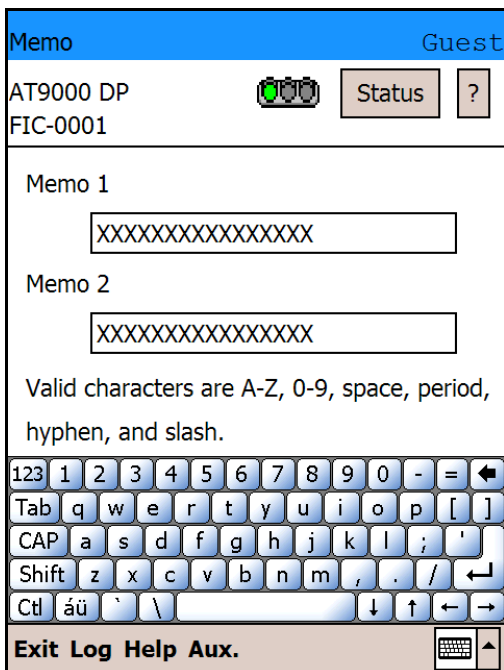

- (3) Enter a memo using the available characters. Once the memo is finished, tap “↵” and the soft keyboard will disappear from the screen.

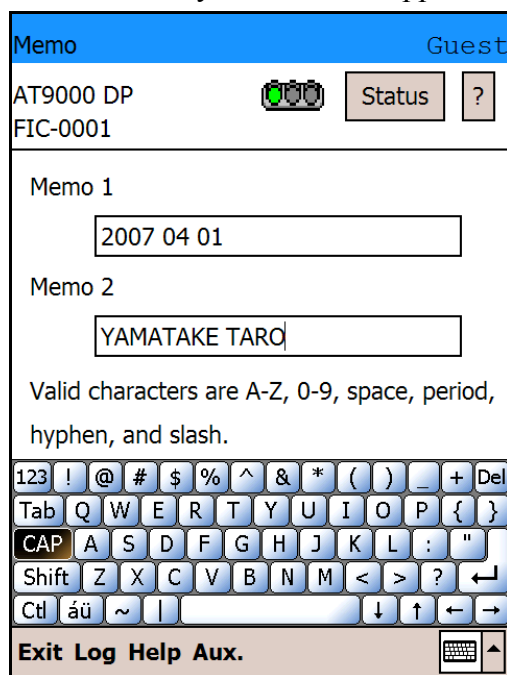

- (4) Tap [Send] to send the changed memos to the device.

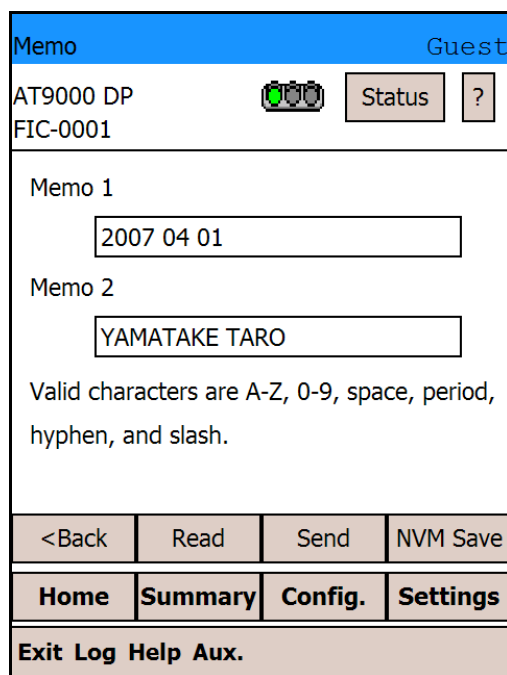

Memo creation is now complete. If you might need to turn off the power of the device within 30 seconds after the transmission of the data, tap [NVM Save] to save your changes. Tapping [Read] reads the set values and displays them again. Tapping [<Back] restores the original screen.

4.21: Monitoring

This screen displays the following parameters:

- Output
- Input
- LRV (0%)
- URV(100%)

Periodically updated Output and Input values can also be displayed. Tapping [Start periodic updates] begins automatic periodic updates of the Output and Input values. Values are updated every six seconds.

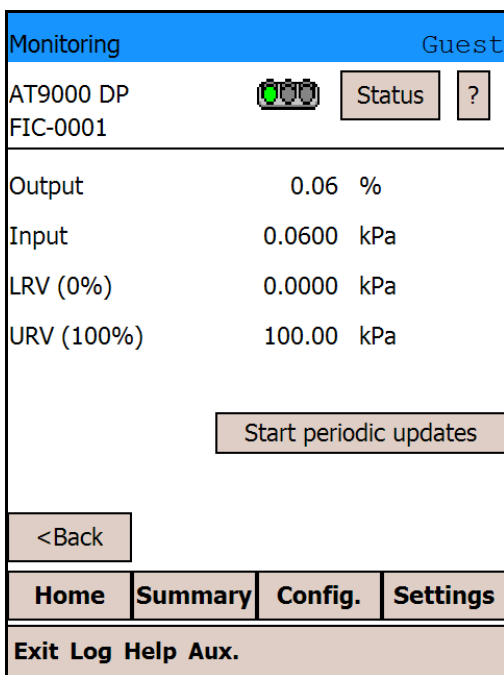

The screen shown below is displayed while periodic updating is activated. To stop periodic updating, tap [Stop periodic updates].

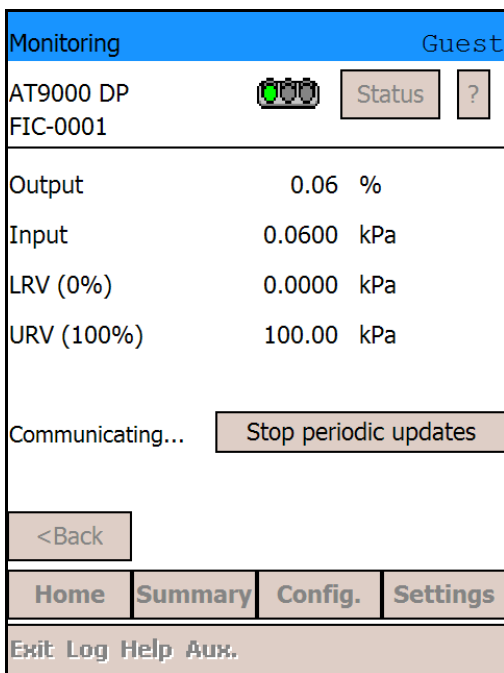

4.22: Adjustment

You can adjust the range on this screen. There are three functions:

- Set LRV (0%): Sets the current input value as the lower limit of the range.
- Set URV: Sets the current input value as the upper limit of the range.
- Set LRV (Actual): Sets the current output value as the specified percentage of output.

4.22.1 Set LRV (0%)

(1) To adjust LRV, tap [Set LRV (0%)].

Adjustment		Guest	
AT9000 DP FIC-0001		Status	?
<div style="margin-bottom: 5px;">Set LRV (0%)</div> <div style="margin-bottom: 5px;">Set URV</div> <div style="margin-bottom: 5px;">Set LRV (Actual)</div>			
Output	0.06	%	
LRV (0%)	0.0000	kPa	▼
URV (100%)	100.00	kPa	
<Back	Read	Send	NVM Save
Home	Summary	Config.	Settings
Exit Log Help Aux.			

(2) A confirmation message appears. Tap [Yes].

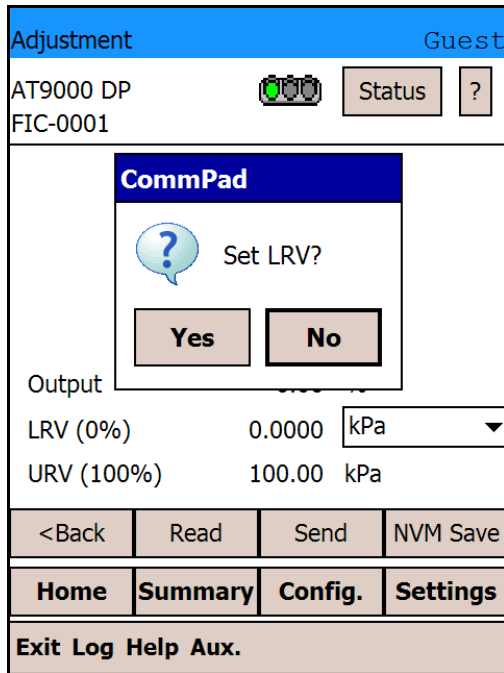

(3) A confirmation message for rereading Output appears. Tap [Yes].

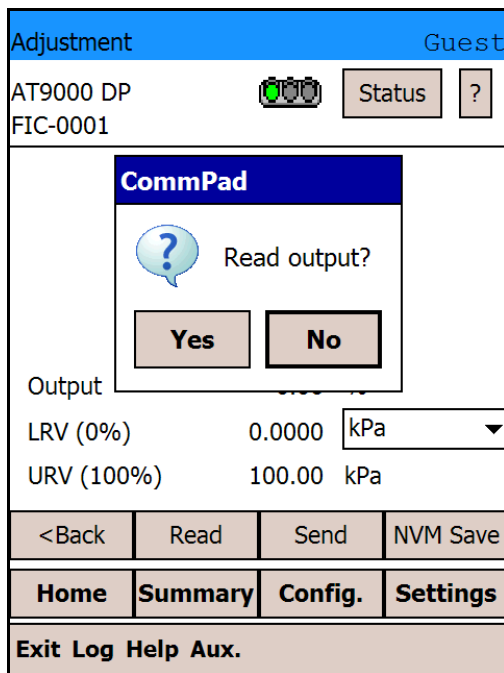

(4) LRV has now changed to the adjusted value.

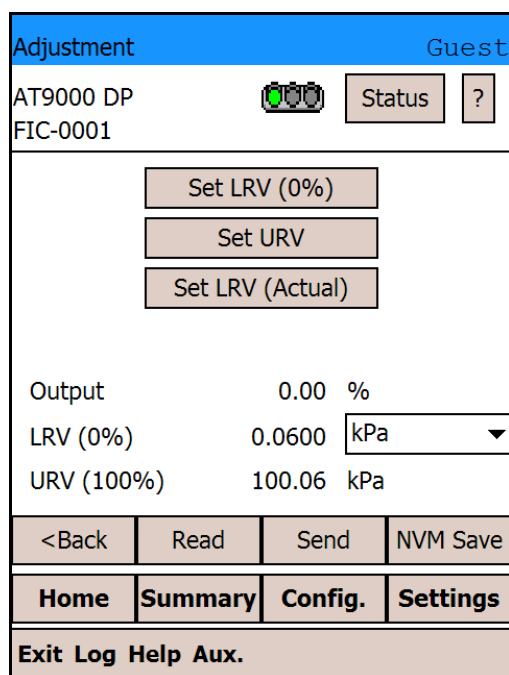

(5) LRV adjustment is now complete. If you might need to turn off the power of the device within 30 seconds after the transmission of the data, tap [NVM Save] to save your changes. Tapping [Read] reads the set values and displays them again. Tapping [<Back] restores the original screen.

4.22.2 URV adjustment

(1) To adjust URV, tap [Set URV].

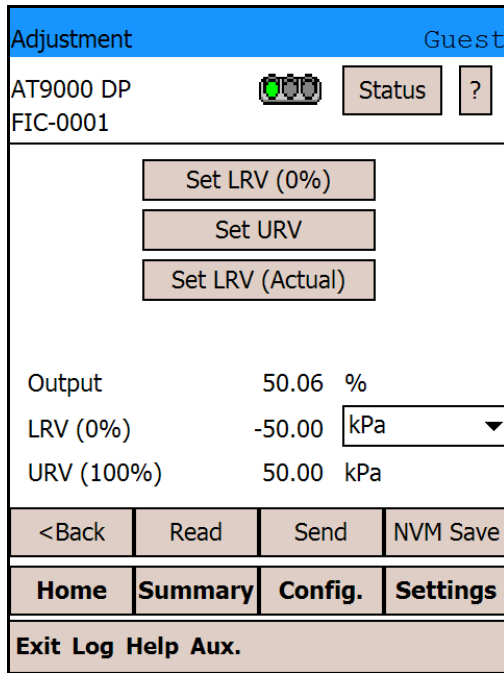

(2) A confirmation message appears. Tap [Yes].

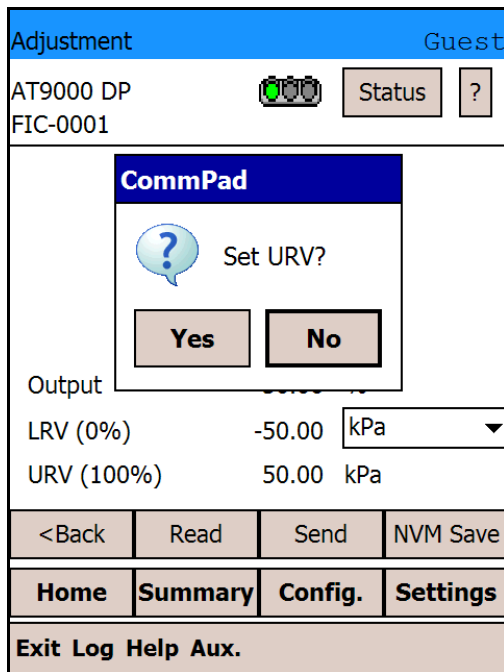

(3) A confirmation message for rereading Output appears. Tap [Yes].

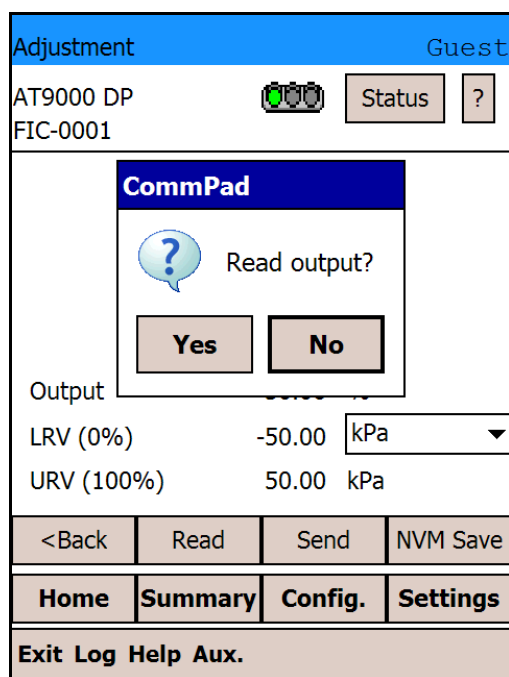

(4) URV has now changed to the adjusted value.

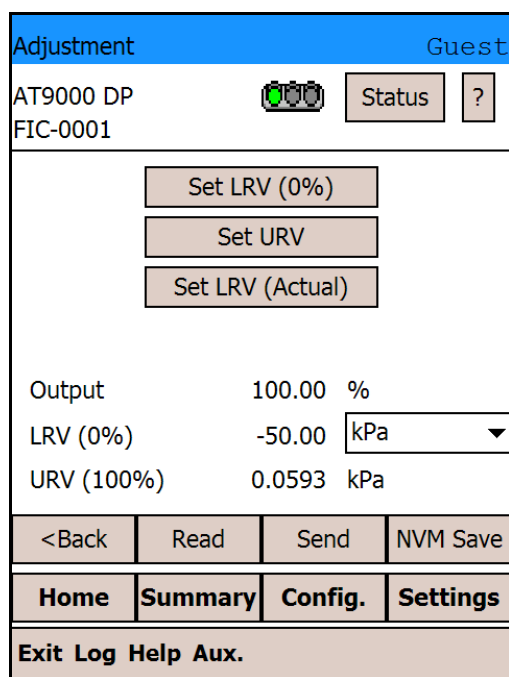

(5) URV adjustment is now complete. If you might need to turn off the power of the device within 30 seconds after the transmission of the data, tap [NVM Save] to save your change. Tapping [Read] reads the set values and displays them again. Tapping [<Back] restores the original screen.

4.22.3 Set LRV (Actual)

- (1) To adjust the LRV so that the current sensor output level becomes a specified percentage of output, tap [Set LRV (Actual)].

Adjustment		Guest	
AT9000 DP FIC-0001			Status ?
<input type="button" value="Set LRV (0%)"/> <input type="button" value="Set URV"/> <input type="button" value="Set LRV (Actual)"/>			
Output	0.06	%	
LRV (0%)	0.0000	kPa ▼	
URV (100%)	100.00	kPa	
<Back	Read	Send	NVM Save
Home	Summary	Config.	Settings
Exit Log Help Aux.			

- (2) Specify the desired percentage of output value, and tap [Enter].

Adjustment		Guest	
Set output value (%)			
Min.	:0.00	Max.	:100.00
<input type="text" value="50"/>			
7	8	9	
4	5	6	
1	2	3	
0	-	.	
Cancel	Back Space	Enter	
Exit Log Help Aux.			

(3) A confirmation message appears. Tap [Yes].

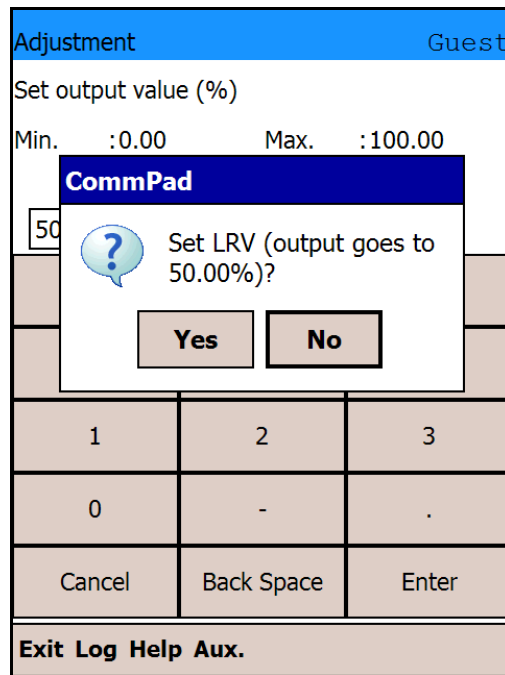

(4) A confirmation message for rereading Output appears. Tap [Yes].

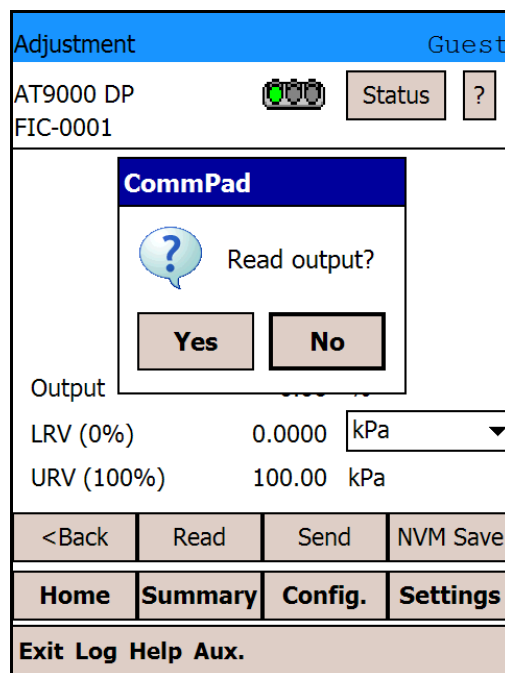

- (5) The range has now been set and Output has changed approximately to the specified output value.

Adjustment		Guest	
AT9000 DP FIC-0001		Status	?
<input type="button" value="Set LRV (0%)"/> <input type="button" value="Set URV"/> <input type="button" value="Set LRV (Actual)"/>			
Output	50.00	%	
LRV (0%)	-49.94	kPa	▼
URV (100%)	50.06	kPa	
<Back	Read	Send	NVM Save
Home	Summary	Config.	Settings
Exit Log Help Aux.			

- (6) Setting of LRV (Actual) is now complete. If you might need to turn off the power of the device within 30 seconds after the transmission of the data, tap [NVM Save] to save your change. Tapping [Read] reads the set values and displays them again. Tapping [<Back] restores the original screen.

4.23: Calibration

Five calibration functions are accessed from this screen.

- Correct zero input: Zero point calibration
- Correct LRV: LRV calibration
- Correct URV: URV calibration
- Restore factory settings: Restoration of factory-set calibrations
- Reset corrections: Deletion of calibrations

[Restore factory settings]

This function is not available for Series 900, so the button is grayed out and disabled. Also, if the device's software version is earlier than B.6, the button will be grayed out and disabled.

4.23.1 Correct zero input

- (1) For zero-point calibration, tap [Correct zero input].

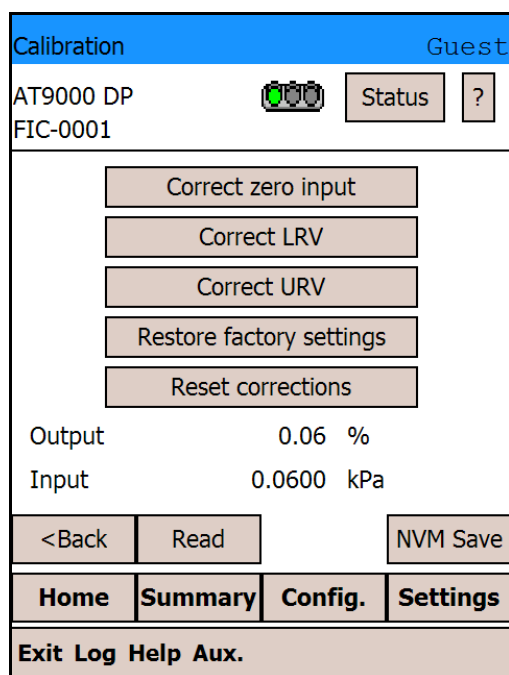

- (2) A confirmation message appears. Check that the input is zero, and tap [Yes].

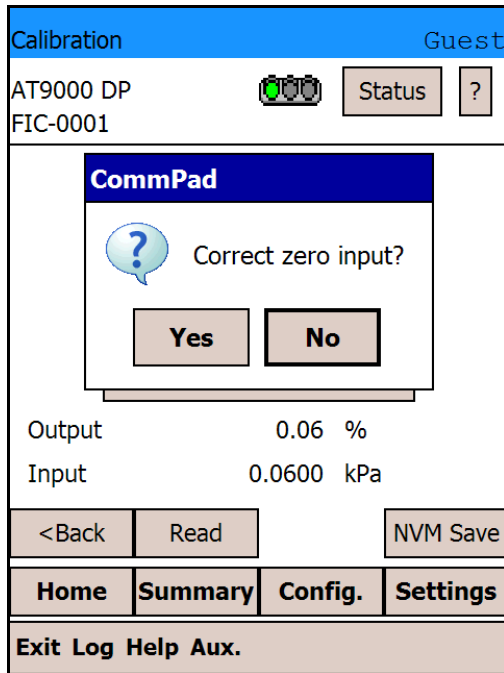

- (3) A confirmation message for rereading Input and Output appears. Tap [Yes].

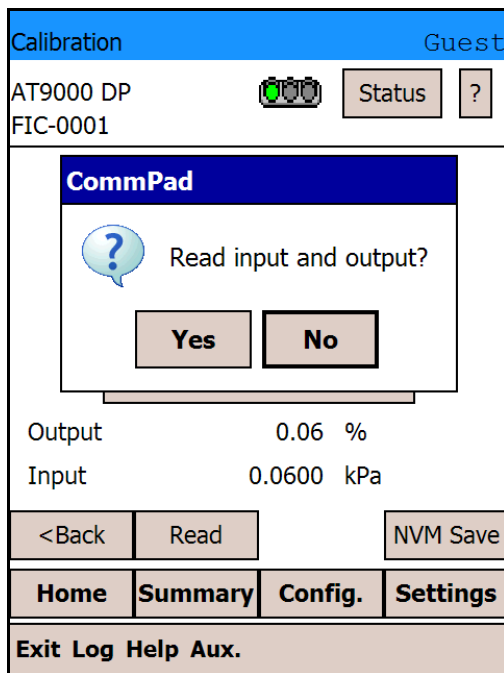

(4) Input has now changed approximately to zero as a result of the calibration.

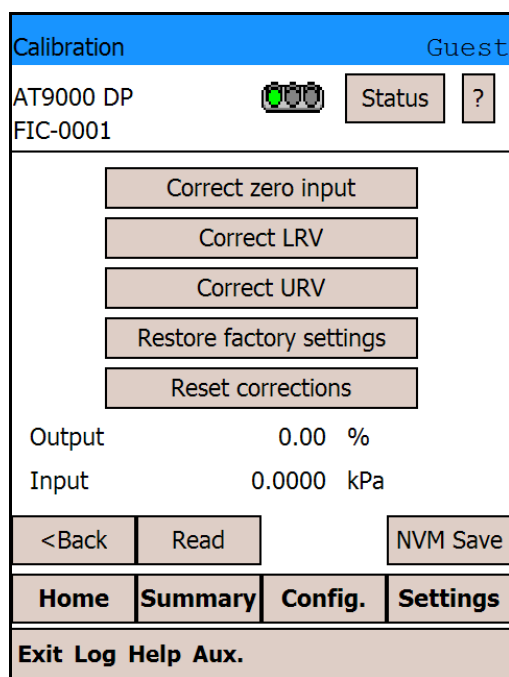

(5) Correct zero input is now complete. If you might need to turn off the power of the device within 30 seconds after the transmission of the data, tap [NVM Save] to save your change. Tapping [Read] reads the set values and displays them again. Tapping [<Back] restores the original screen.

4.23.2 Correct LRV

(1) For LRV calibration, tap [Correct LRV].

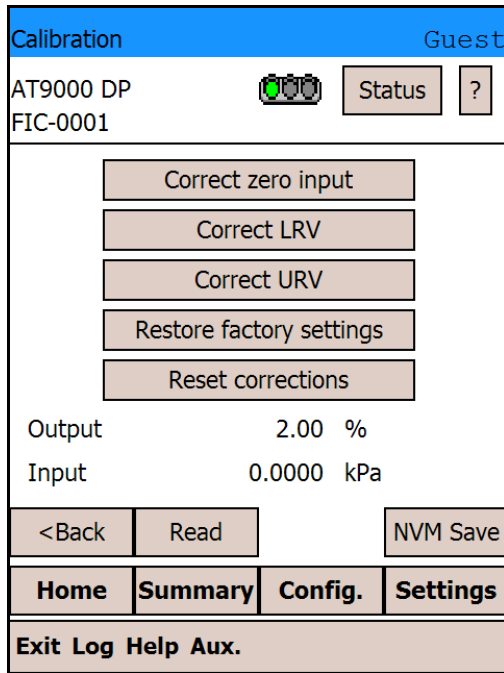

(2) A confirmation message appears. Check that Input is correct, and tap [Yes].

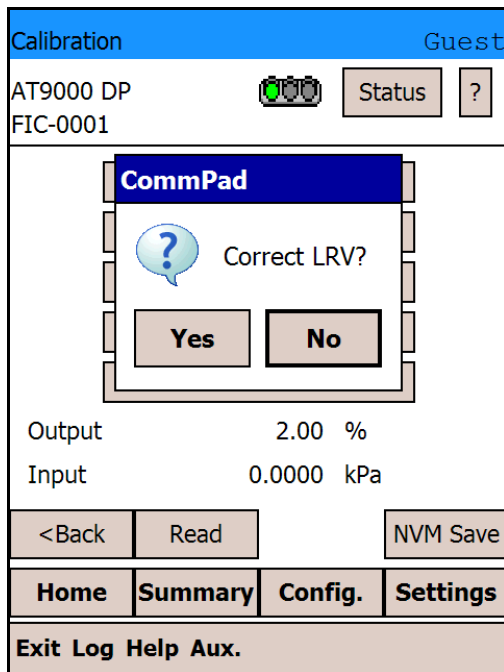

(3) A confirmation message for rereading Input and Output appears. Tap [Yes].

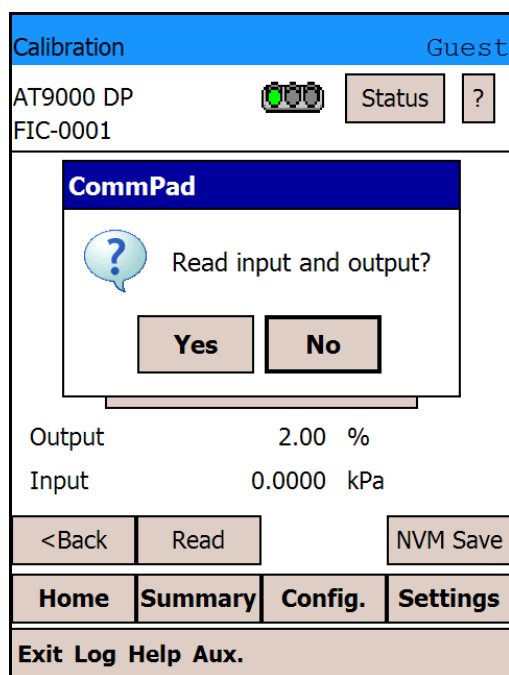

(4) Input has now changed approximately to zero as a result of the calibration.

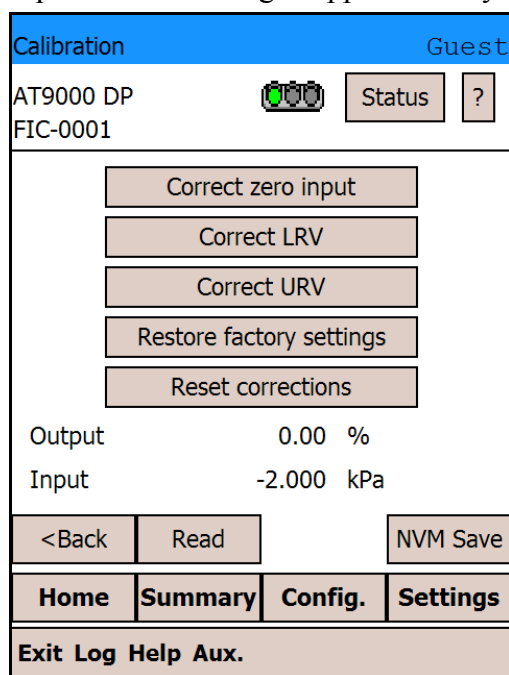

(5) Correct LRV is now complete. If you might need to turn off the power of the device within 30 seconds after the transmission of the data, tap [NVM Save] to save your change. Tapping [Read] reads the set values and displays them again. Tapping [<Back] restores the original screen.

4.23.3 Correct URV

(1) For URV calibration, tap [Correct URV].

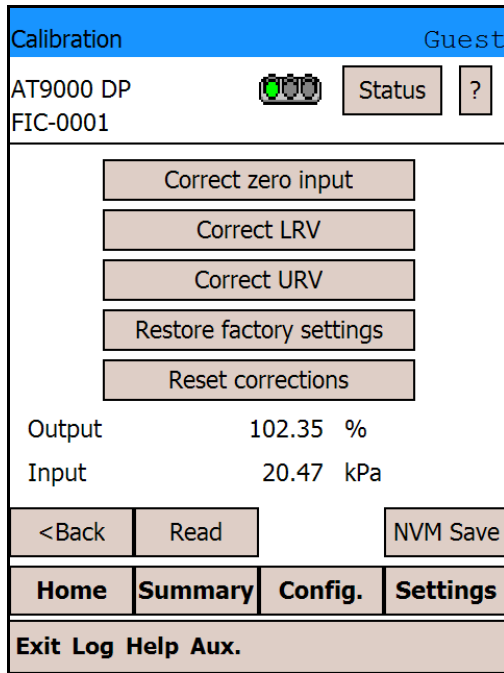

(2) A confirmation message appears. Check that Input is correct, and tap [Yes].

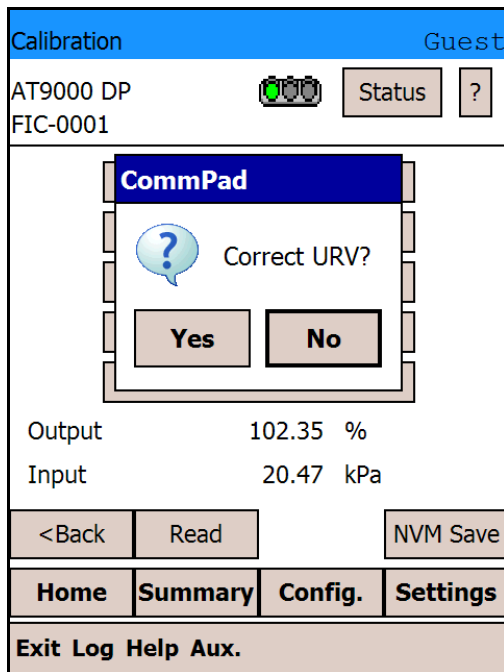

(3) A confirmation message for rereading Input and Output appears. Tap [Yes].

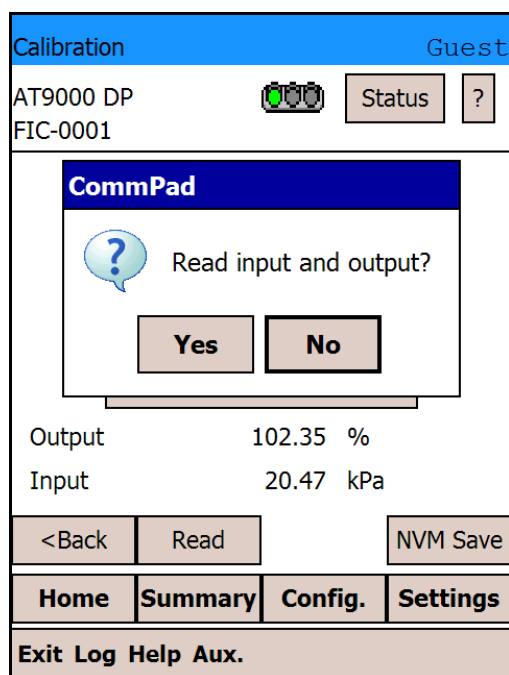

(4) Output has now changed approximately to 100% as a result of the calibration.

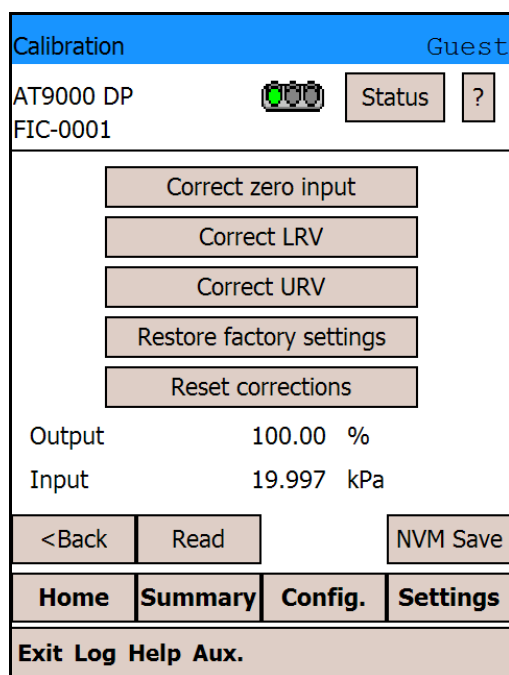

(5) Correct URV is now complete. If you might need to turn off the power of the device within 30 seconds after the transmission of the data, tap [NVM Save] to save your change. Tapping [Read] reads the set values and displays them again. Tapping [<Back] restores the original screen.

4.23.4 Restore factory settings

- (1) To revert the calibrated data to the factory calibration settings, tap [Restore factory settings].

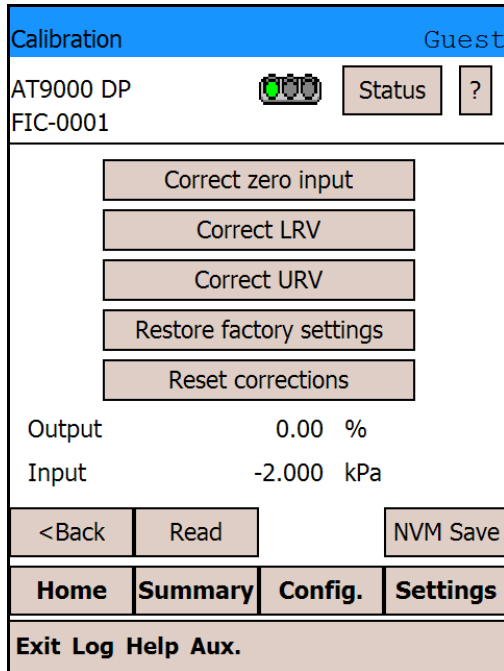

- (2) A confirmation message appears. Tap [Yes].

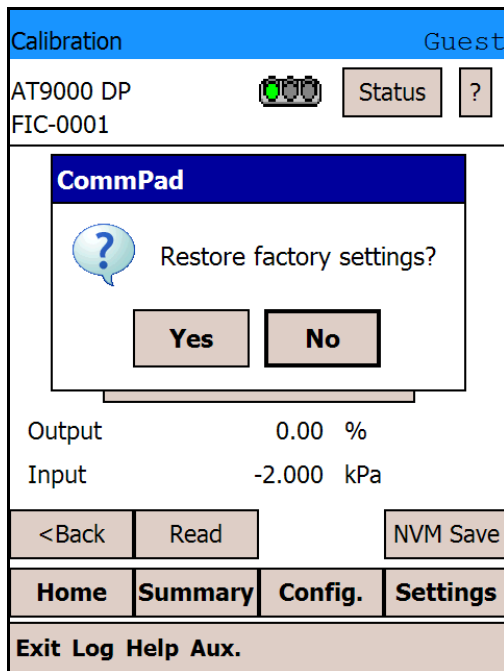

4.23.5 Reset corrections

Note: Since resetting calibrated data deletes the calibrated data stored in the device, measurements may not be correct afterwards. Be sure to re calibrate after executing Reset Corrections.

- (1) To delete calibration data, tap [Reset corrections].

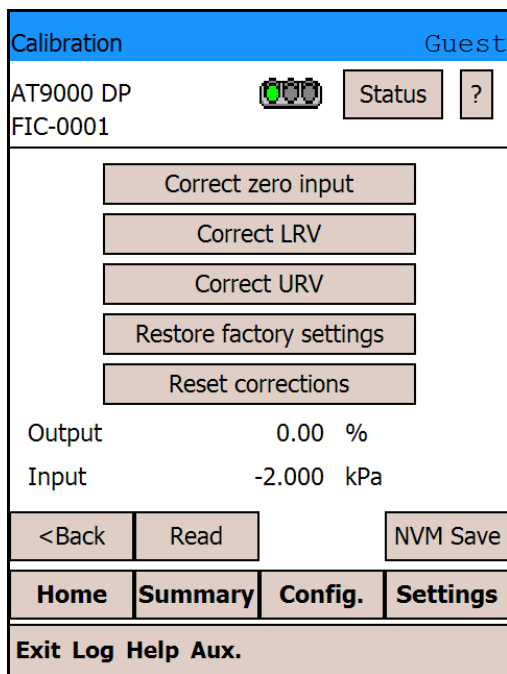

- (2) A confirmation message appears. Tap [Yes].

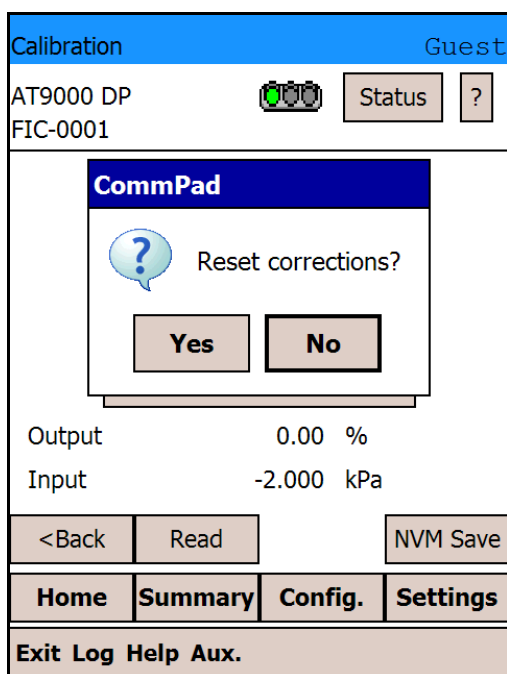

(3) A confirmation message for rereading Input and Output appears. Tap [Yes].

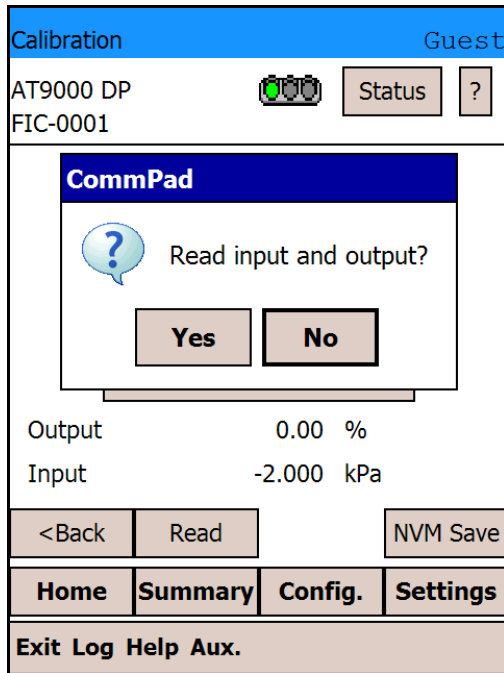

Note: Tapping [Reset corrections] changes the traffic light icon to yellow. Tapping [Status] will display further information.

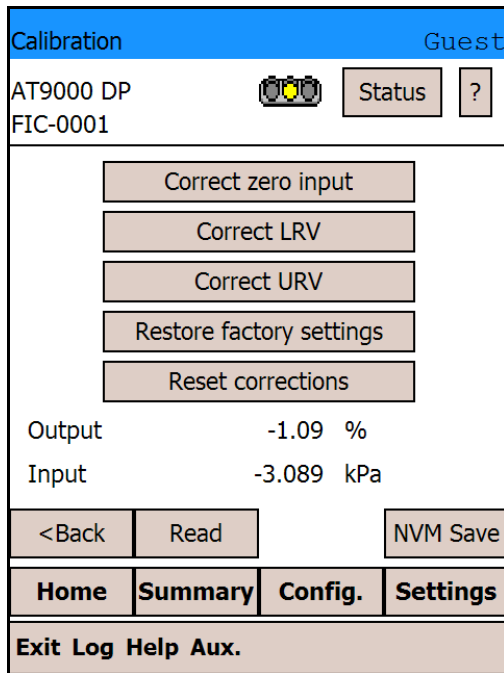

The status is now Correct Reset.

Status	Guest
	<input data-bbox="890 324 927 376" type="button" value="?"/>
Non-critical Status: Correct Reset	
<input data-bbox="448 772 544 817" type="button" value("<back"=""/>	
Exit Log Help Aux.	

After using the Reset Corrections function, you must always re calibrate. Executing Correct LRV (or Correct zero input) and Correct URV will cancel the Correct Reset status.

If you use Correct LRV (or Correct zero input) only, you can cancel the Correct Reset status by turning the power of the device off and then back on after using [NVM Save].

4.24: Output Mode

This screen is used to set and cancel output mode. There are two ways to set output mode: by selecting one of five preset values (0%, 25%, 50%, 75%, 100%) or by inputting a value of your choice.

Setting Output Mode at 75%

- (1) To set output mode at 75%, tap [75% (16 mA)].

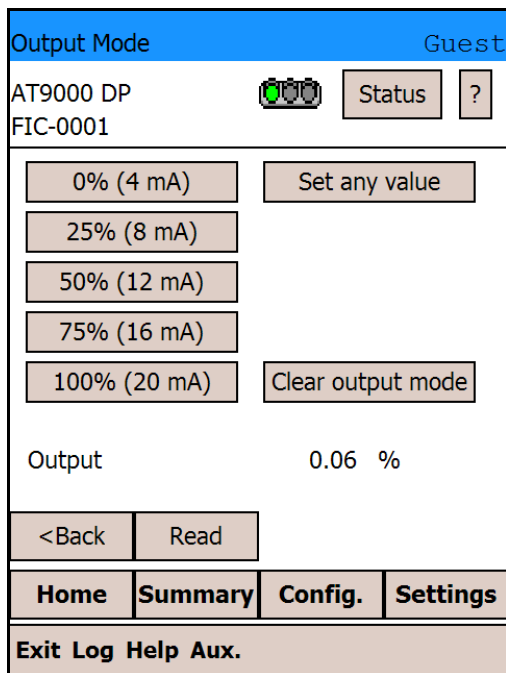

- (2) A confirmation message appears. Tap [Yes].

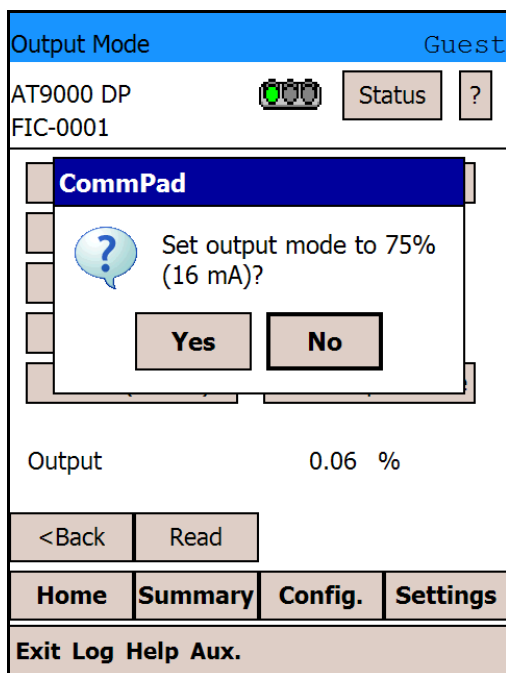

- (3) The device is now in output mode, and the traffic light icon changes to yellow.

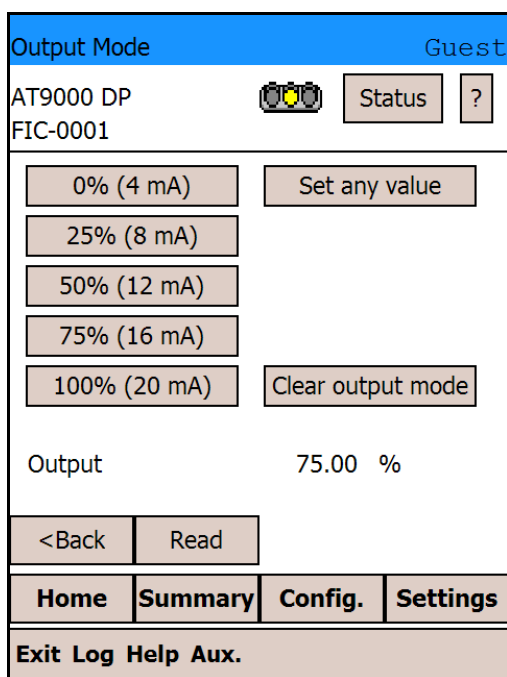

- (4) To clear output mode, tap [Clear output mode]. A confirmation message appears. Tap [Yes].

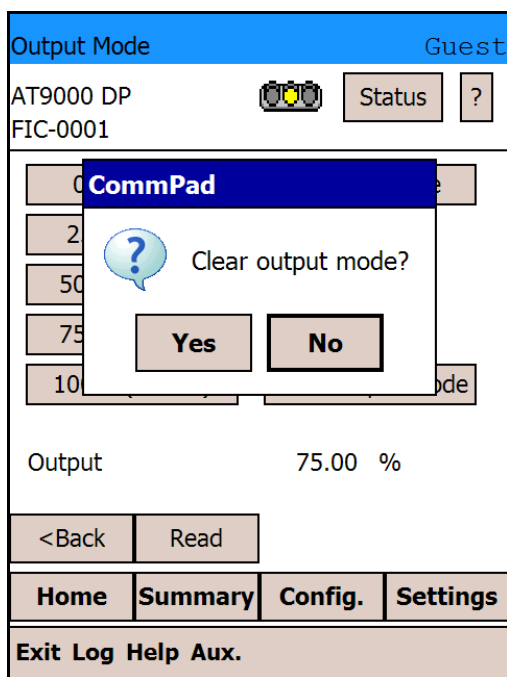

- (5) Output mode is now cleared.
Note that even if you do not clear output mode, the device will automatically clear it after approximately 10 minutes without communication.
 To set the Output Mode to a value of your choice, tap [Set any value].

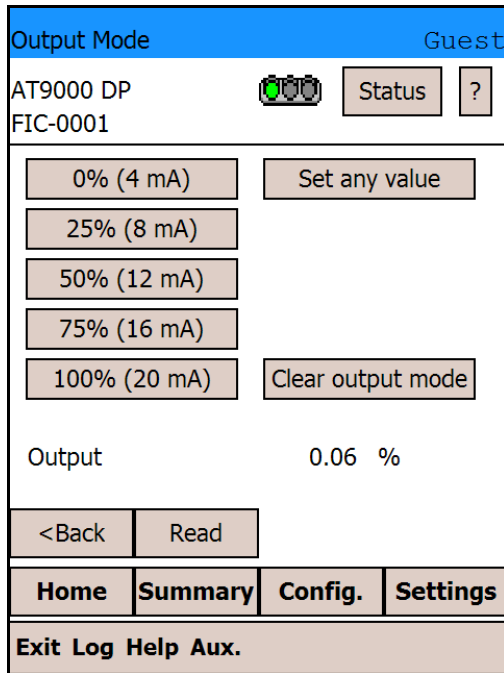

Setting a Value of Your Choice

- (6) Enter a value within the valid configuration range between the displayed max. and min. values and tap [Enter]. The configuration range varies depending on how the output standard is configured.
 If the analog output level is not compliant with NAMUR NE 43, [Min.] is -2.50 and [Max.] is 110.00.
 If the analog output level is compliant with NAMUR NE 43, [Min.] is -1.25 and [Max.] is 103.12.
 If DE mode, without relation to the output standard, [Min.] is -2.50, [Max.] is 110.00.

Output Mode			Guest
Output Mode (%)			
Min.	: -2.50	Max.	: 110.00
<input style="width: 100px;" type="text" value="60"/>			
7	8	9	
4	5	6	
1	2	3	
0	-	.	
Cancel	Back Space	Enter	
Exit Log Help Aux.			

- (7) A confirmation message appears. Tap [Yes].

Output Mode			Guest						
Output Mode (%)									
Min.	: -2.50	Max.	: 110.00						
<table border="1" style="margin: auto;"> <tr> <td style="width: 30px; height: 20px; text-align: center;">6</td> </tr> </table>				6					
6									
<table border="1" style="margin: auto;"> <tr> <td colspan="2" style="background-color: #000080; color: white; padding: 5px;">CommPad</td> </tr> <tr> <td style="text-align: center; width: 40px;"></td> <td style="padding: 5px;">Set output mode to 60%?</td> </tr> <tr> <td style="text-align: center; width: 40px;"><input type="button" value="Yes"/></td> <td style="text-align: center; width: 40px;"><input type="button" value="No"/></td> </tr> </table>				CommPad			Set output mode to 60%?	<input type="button" value="Yes"/>	<input type="button" value="No"/>
CommPad									
	Set output mode to 60%?								
<input type="button" value="Yes"/>	<input type="button" value="No"/>								
1	2	3							
0	-	.							
Cancel	Back Space	Enter							
Exit Log Help Aux.									

Moving to another screen

If you try to move from the Output Mode screen to another screen without first clearing output mode, the confirmation message “Still in output mode. Exit output mode?” appears. If you want to clear output mode, tap [Yes]. If you want to move to another configuration screen without clearing output mode, tap [No].

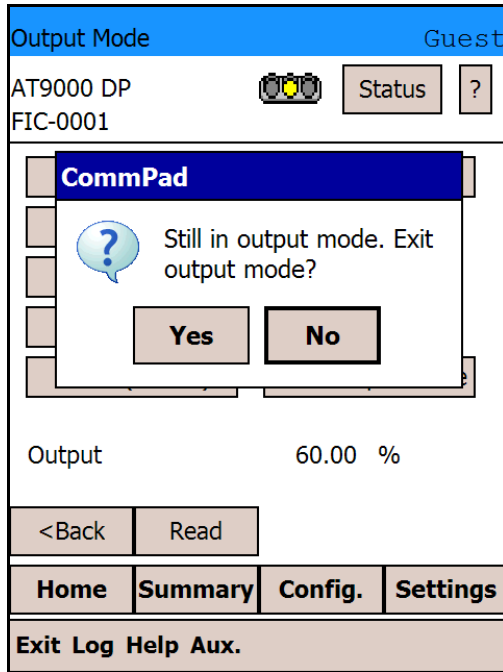

4.25: 4-20 mA Correct

This screen is for calibration of the analog output signal.

Note: Normally you do not need to calibrate the analog output signal. Do not calibrate it under normal circumstances. However, if calibration is absolutely necessary, the following items are required:

- A high-precision ammeter with an accuracy of 0.03% F.S. or higher
- A 250Ω resistor (±0.005%).

(1) For 4 mA output calibration, tap [Correct 4 mA].

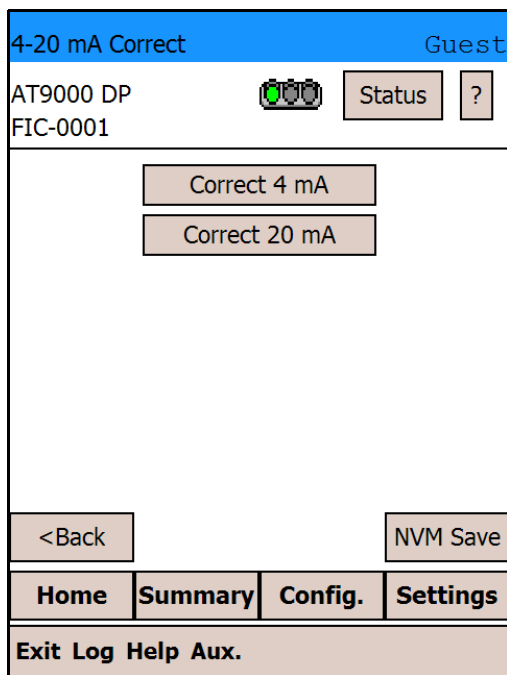

(2) Output mode will be set to 4mA, tap [OK].

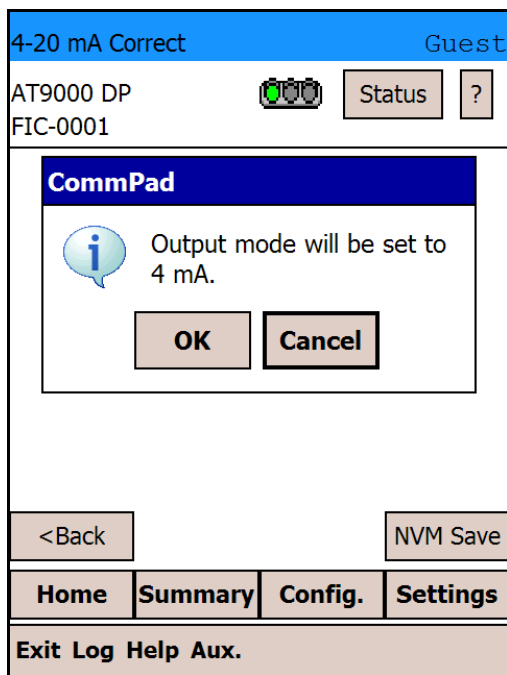

- (3) After the device is set to the 4 mA output mode, the “Correct 4 mA” screen appears. Read the ammeter, and if you want to increase the output signal, tap [Up]. If you want to decrease the output signal, tap [Down].

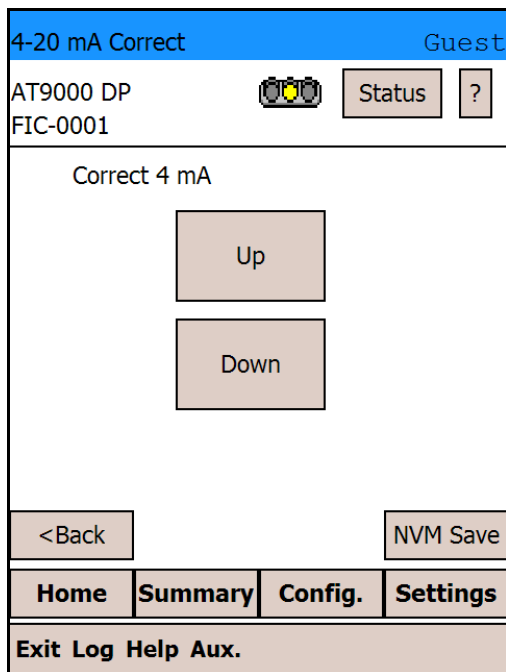

- (4) Calibration of the 4mA output signal is complete. If you might need to turn off the power of the device within 30 seconds after the transmission of the data, tap [NVM Save] to save your change. Tap [< Back] to return to the initial 4-20 mA Correct screen after clearing output mode.

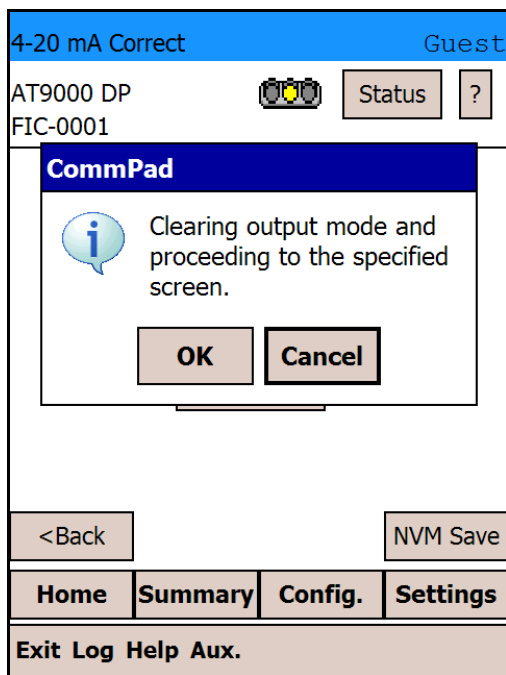

- (5) You can do 20 mA calibration in the same way as 4 mA calibration.

4.26: PROM No.

Use this screen to check the device PROM No.

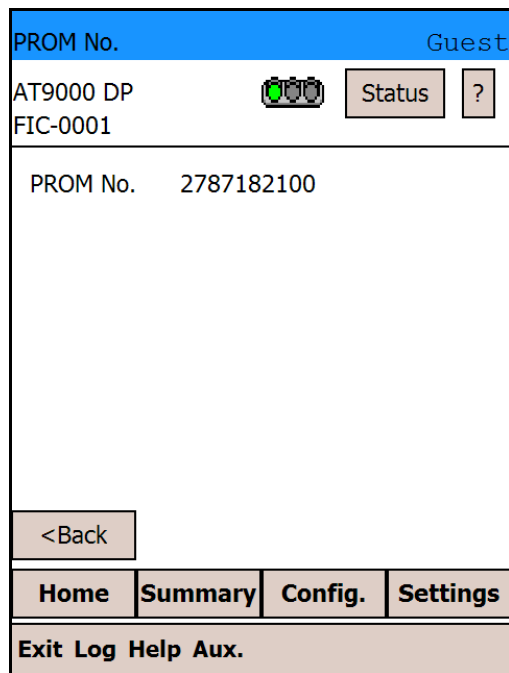

Tapping [<Back] restores the original screen.

4.27: Software Version

Use this screen to check the software versions of the device and of CommPad.

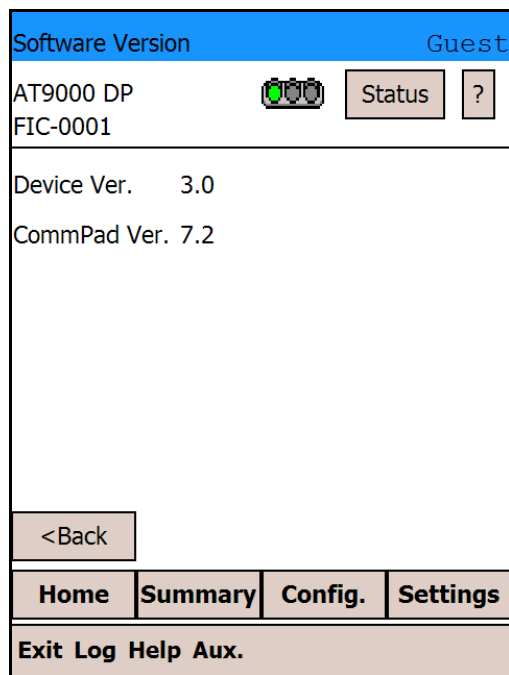

Tapping [<Back] restores the original screen.

4.28: Sensor Temp.

Use this screen the sensor temperature to check.

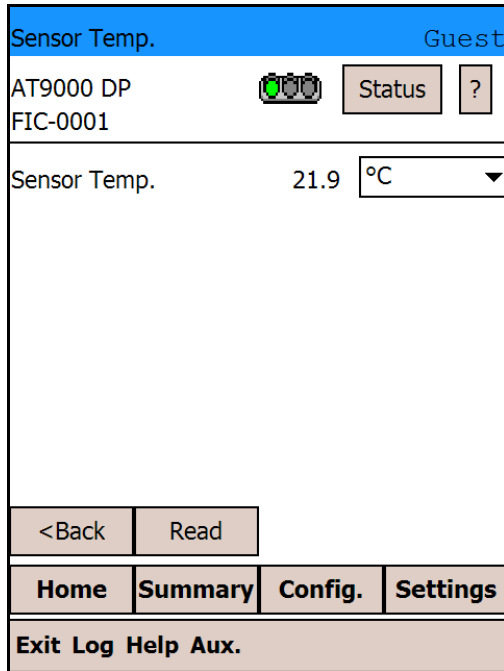

Tapping [Read] reads the sensor temperature and displays them again. Tapping [<Back] restores the original screen.

4.29: DE/Analog Select (Switching between digital and analog communications output)

Use this screen to switch between DE and analog modes.

- (1) Tap [Switch DE <---> Analog].

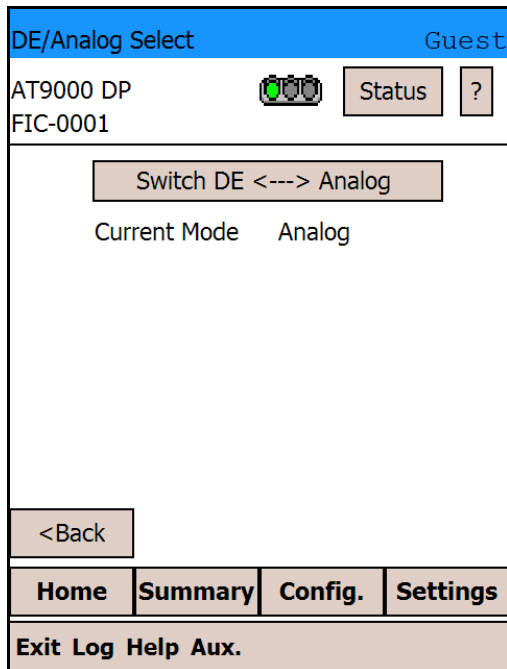

- (2) A confirmation message appears. Tap [Yes].

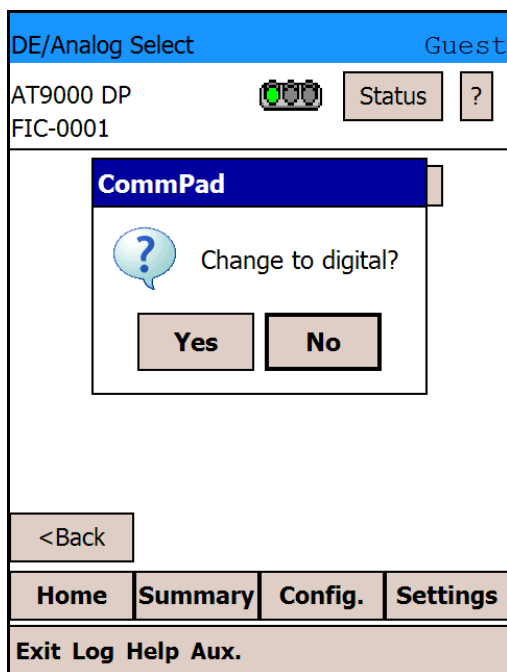

(3) A confirmation message appears again, Tap [Yes].



(4) Another confirmation message appears. Tap [OK].

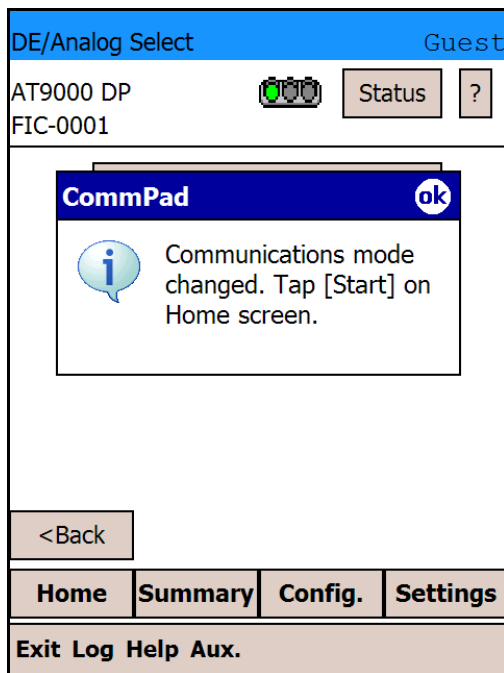

(5) The Home screen appears. Tap [Start].

4.30: DE Configuring

You can configure DE-related parameters on this screen. Tap the drop-down menu for FS Mode, Format, or PV type, and then tap [Send]

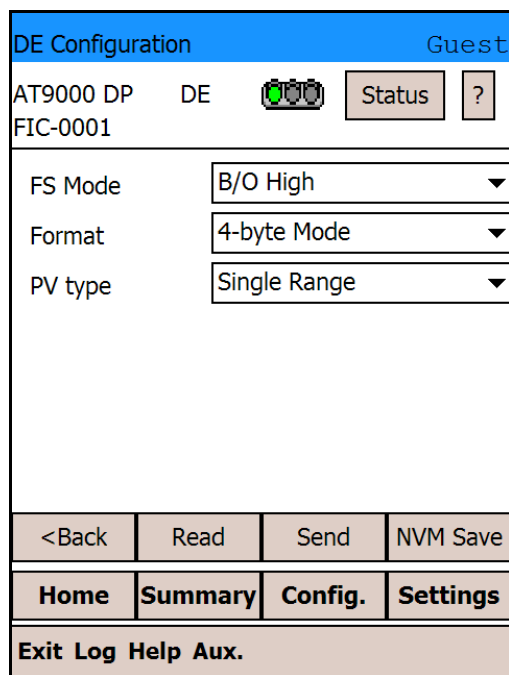

If you might need to turn off the power of the transmitter within 30 seconds after the transmission of the data, tap [NVM Save] to save your change.

4.31: Records

You can display status records on this screen. There are three functions:

- Zero Calibr. Log in CommPad: Displays CommPad's internal zero calibration record, which is saved when zero calibration of the device is done by CommPad.
- Zero Calibr. Log in Device: Displays the zero point calibration data saved in the device.
- Status Records: Displays device status records saved in the device.

4.31.1 Zero Calibr. Log in CommPad

- (1) To display the record of the zero calibration amounts saved in CommPad, tap [Zero Calibr. Log in CommPad].

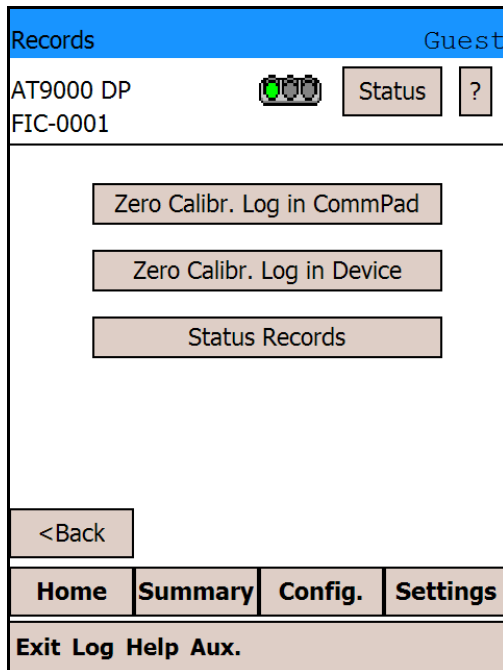

(2) Saved data appears on the screen.

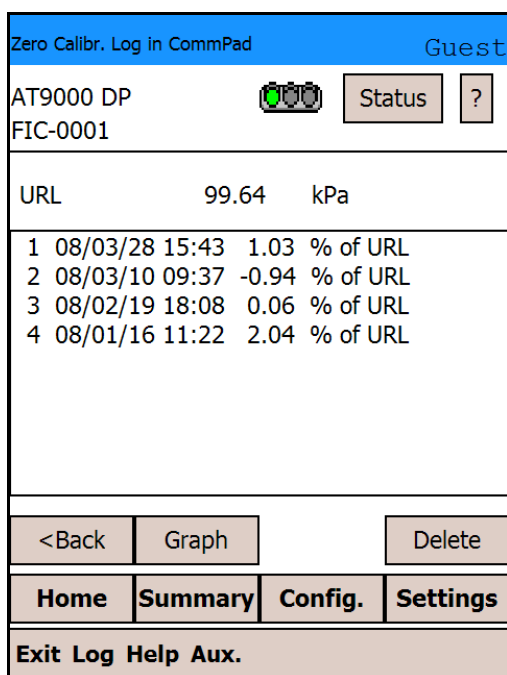

(3) To change the display to a graphical form, tap [Graph].

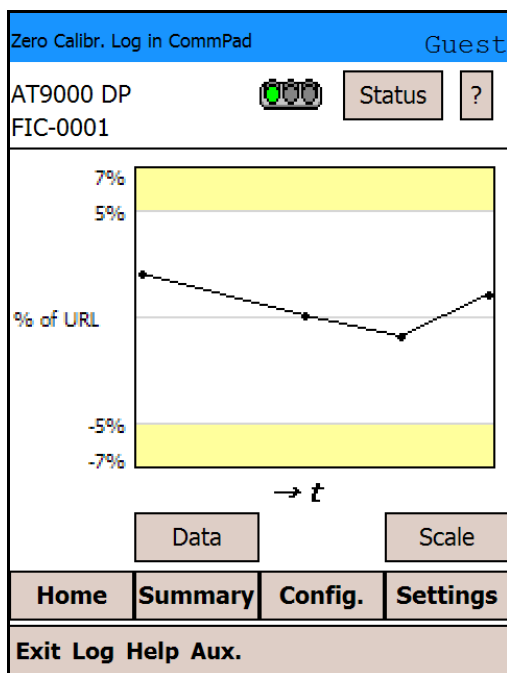

- (4) Tapping [Scale] will change the scale as appropriate for the maximum value of the data.

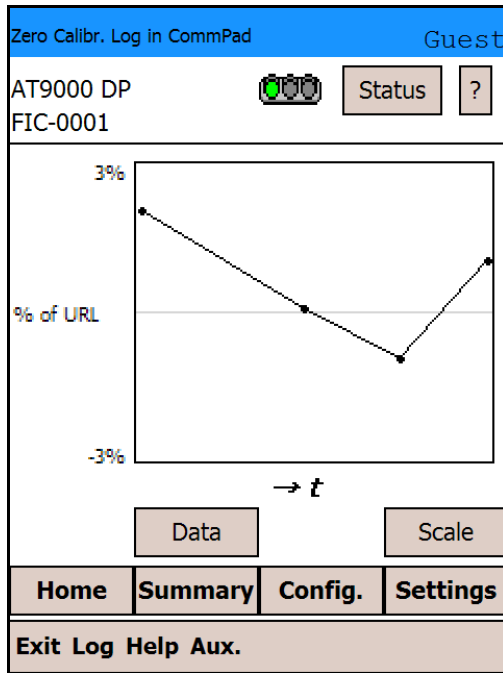

- (5) To delete data, tap the unnecessary line to highlight it, and then tap [Delete].

Zero Calibr. Log in CommPad Guest

AT9000 DP FIC-0001

URL 99.64 kPa

1	08/03/28 15:43	1.03	% of URL
2	08/03/10 09:37	-0.94	% of URL
3	08/02/19 18:08	0.06	% of URL
4	08/01/16 11:22	2.04	% of URL

<Back Graph Delete

Home Summary Config. Settings

Exit Log Help Aux.

(6) A confirmation message appears. Tap [Yes].

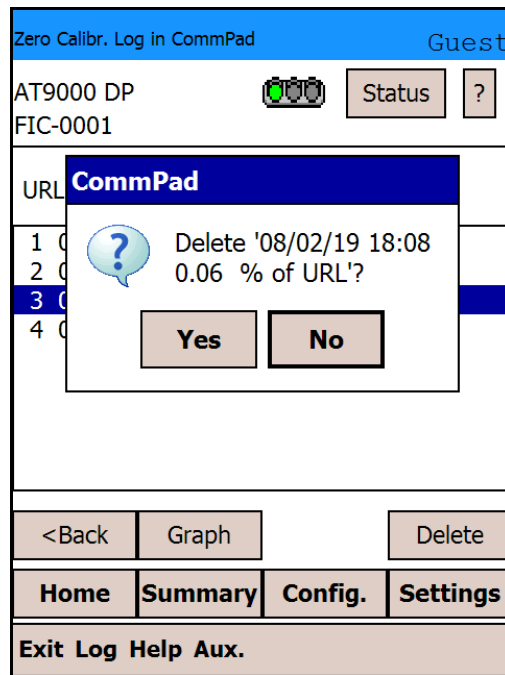

(7) The data that was highlighted is now deleted.

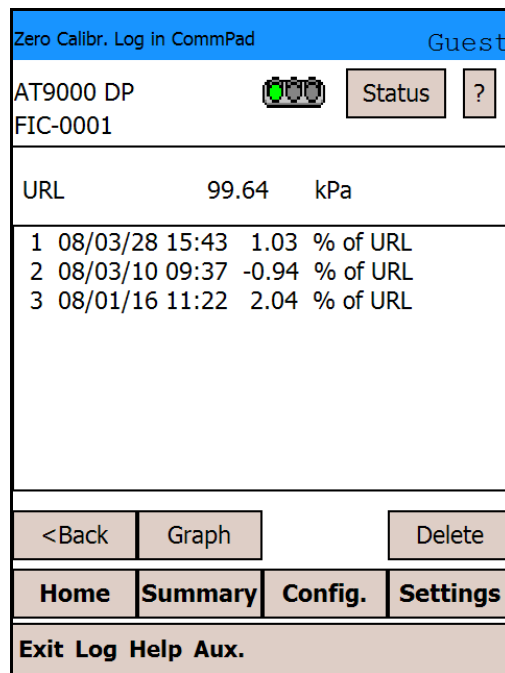

4.31.2 Zero Calibr. Log in Device

- (1) To display zero calibration records saved in the device, tap [Zero Calibr. Log in Device].

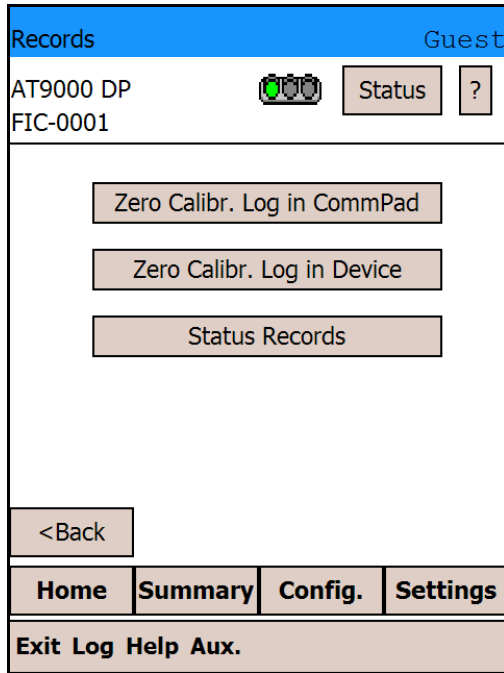

- (2) Up to five records are saved.

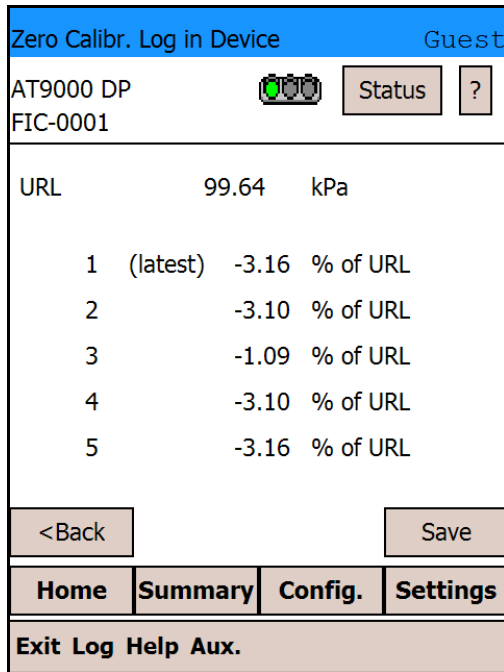

- (3) By tapping [Save], you can save the displayed data to a file. The file name is supplied automatically. Tap [OK] without changing anything.

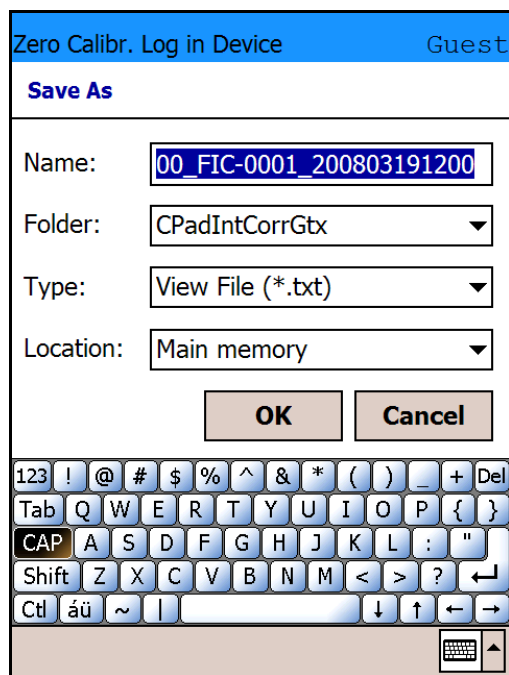

The name of the automatically-named file has the following structure:

IC_(PROMID)_(tag name)_(year/month/day/hour/minute).txt

If either of the following 2 characters that cannot be used in a Windows file name is contained in the tag name, the character(s) will be converted automatically as indicated:

Character	Replacement
. (dot)	_ (underscore)
/ (slash)	~ (tilde)

(4) Tap [ok].

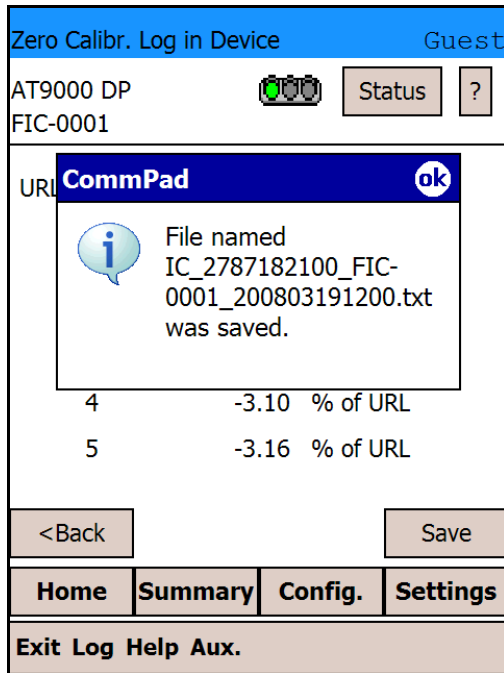

The saved file can be copied to your PC and viewed there. The file can be opened with a text editor or other software.

The data will look like the example shown below.

Zero Calibration Data in Device		
2006/05/19 08:37		
1(latest)	-0.21	% of URL
2	-0.21	% of URL
3	-0.23	% of URL
4	-0.23	% of URL
5	-0.22	% of URL

4.31.3 Status Records

(1) To display records of device status, tap [Status Records].

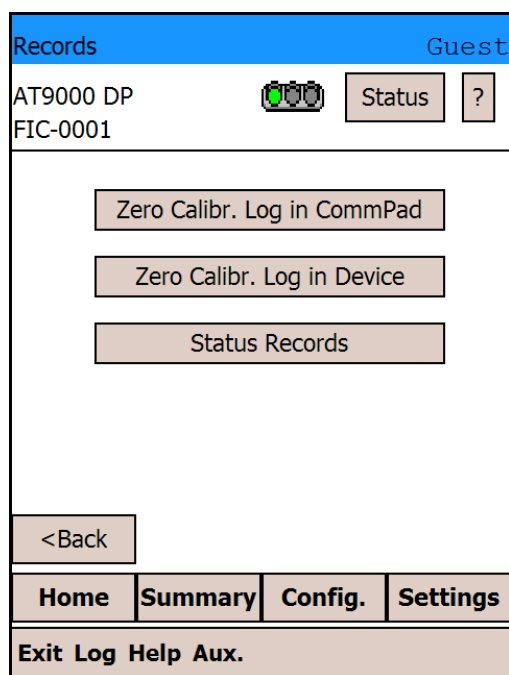

(2) The status records are displayed.

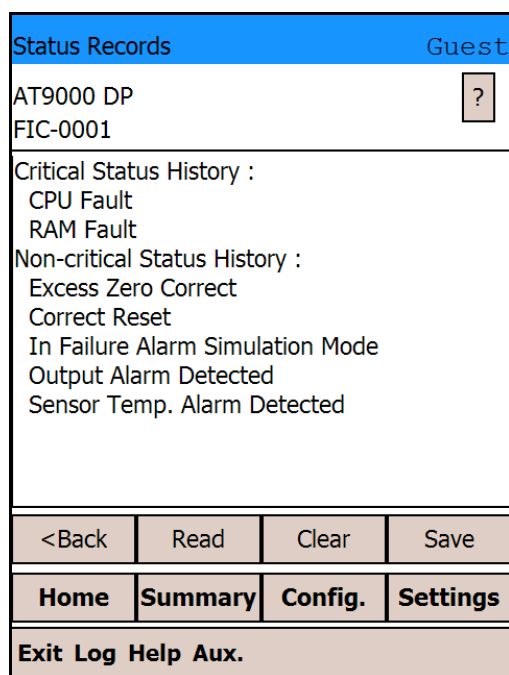

For more information on error messages, see chapter 6, “Troubleshooting.” Note that some of the troubleshooting messages listed there are not recorded as part of the status records.

- (3) If no critical failure or non-critical instrument status condition has occurred, “None” appears on the screen as below.

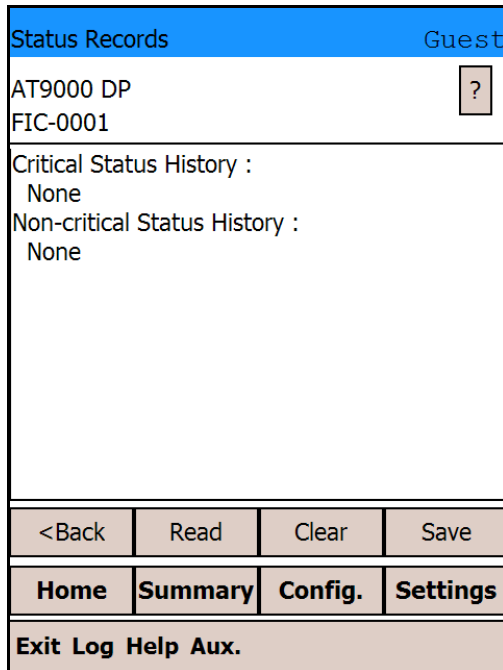

- (4) By tapping [Save], you can save the displayed data to a file. The file name is supplied automatically. Tap [OK] without changing anything.

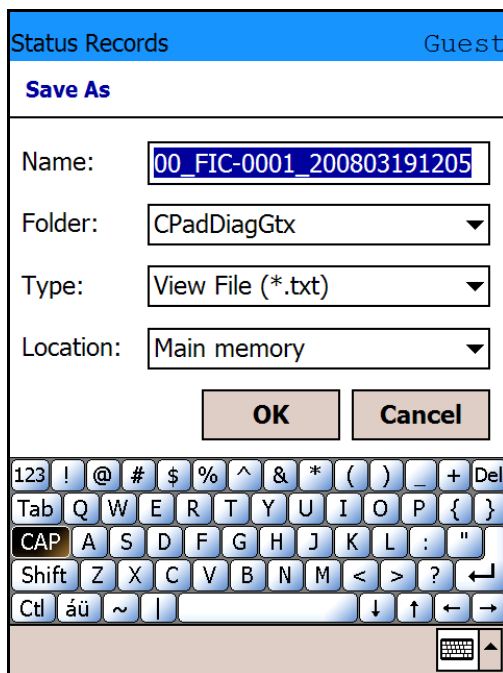

The name of the automatically-named file has the following structure:

IC_(PROMID)_(tag name)_(year/month/day/hour/minute).txt

If either of the following 2 characters that cannot be used in a Windows file name is contained in the tag name, the character(s) will be converted automatically as indicated:

Character	Replacement
. (dot)	_ (underscore)
/ (slash)	~ (tilde)

- (5) To clear the status record, tap [Clear]. The “Save” screen appears. If you need to save the data before clearing it, tap [Yes]. If you do not need to save the data, tap [No].

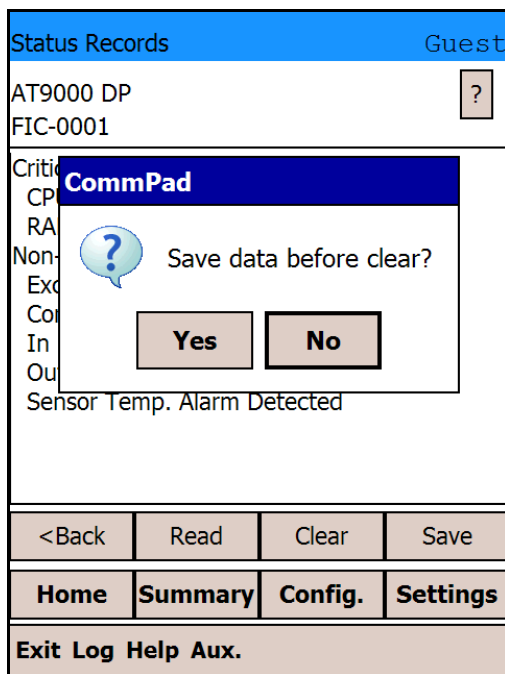

(6) A confirmation message will appear. Tap [Yes].

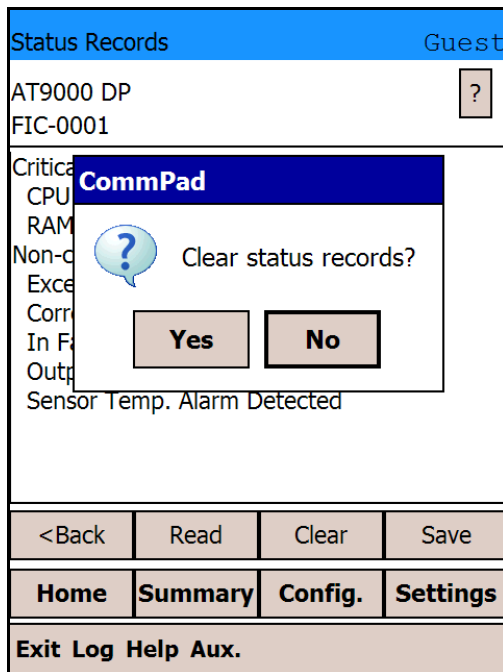

The saved file can be copied to your PC and viewed there. The file can be opened with a text editor or other software. The data will look like the example shown below.

```

Status Record
2006/05/19 08:38
Critical Status History:
  Chara. PROM Fault
  Suspect Input
  ROM Fault
  Invalid Database
Non-critical Status History:
  Meter Body Over Temperature
  Meter Body Overload
  Or Meter Body Fault
  Correct Reset
    
```

4.32: Alarm/Contact Output

This screen is used to configure Alarm/Contact Output.

The Alarm/Contact Output screen consists of two pages. Switch between pages using the [Next >] and [< Prev.] buttons.

On the Alarm/Contact Output screen (first page), you can configure the alarm.

Two kinds of alarms are available: Output Alarm and Sensor Temp. Alarm. When an alarm condition is detected, it is logged in the status history of the device.

- (1) Tap the “Alarm/Contact Output” drop-down menu, and a list of alternative output alarms will appear. Select the desired alarm.

Alarm/Contact Output		Guest	
AT9000 DP		Status	?
FIC-0001			
Output Alarm	No Alarm		
Lower Limit	No Alarm		
Upper Limit	Upper Limit		
Sensor Temp. Alarm	Upper/Lower Limit		
	No Alarm		
Lower Limit	-	-	▼
Upper Limit	-	°C	
Next>			
<Back	Read	Send	NVM Save
Home	Summary	Config.	Settings
Exit Log Help Aux.			

- (2) To change the lower limit of the output alarm, tap the “Lower Limit” display field of the Output Alarm.

Alarm/Contact Output		Guest	
AT9000 DP			Status ?
FIC-0001			
Output Alarm	Upper/Lower Limit ▼		
Lower Limit	<input type="text" value="-"/>	%	
Upper Limit	<input type="text" value="-"/>	%	
Sensor Temp. Alarm	No Alarm ▼		
Lower Limit	<input type="text" value="-"/>	<input type="text" value="-"/>	▼
Upper Limit	<input type="text" value="-"/>	°C	
Next>			
<Back	Read	Send	NVM Save
Home	Summary	Config.	Settings
Exit Log Help Aux.			

- (3) The input screen for the lower limit will appear. Enter the value you want to set, and tap [Enter].

Alarm/Contact Output		Guest	
Lower Limit (Output Alarm)			
Min.	: -199.9	Max.	: 199.9
<input type="text" value="-5"/>			
7	8	9	
4	5	6	
1	2	3	
0	-	.	
Cancel	Back Space	Enter	
Exit Log Help Aux.			

Similarly, enter the value you want to set for the upper limit of the output alarm, and tap [Enter]. Configure the Sensor Temp. Alarm in the same way.

(4) Tap [Send] to transmit the set value to the device.

Alarm/Contact Output		Guest	
AT9000 DP FIC-0001			Status ?
Output Alarm	Upper/Lower Limit ▾		
Lower Limit	<input type="text" value="-5.0"/>	%	
Upper Limit	<input type="text" value="125.0"/>	%	
Sensor Temp. Alarm	Upper/Lower Limit ▾		
Lower Limit	<input type="text" value="-10.0"/>	<input type="text" value="°C"/>	▾
Upper Limit	<input type="text" value="60.0"/>	<input type="text" value="°C"/>	
Next>			
<Back	Read	Send	NVM Save
Home	Summary	Config.	Settings
Exit Log Help Aux.			

If you might have to turn off the device power within 30 seconds after the transmission of the set value, tap [NVM Save].

Tapping [Read] rereads the set value and redisplay it. Tap [Next >], and the Alarm/Contact Output screen (second page) will appear.

- (5) On the Alarm/Contact Output screen (second page), you can configure and simulate the contact outputs shown below. And you can determine whether or not the contact output is upon detection of an alarm condition. Contact output can be configured to open or close the circuit upon detection of an alarm condition.

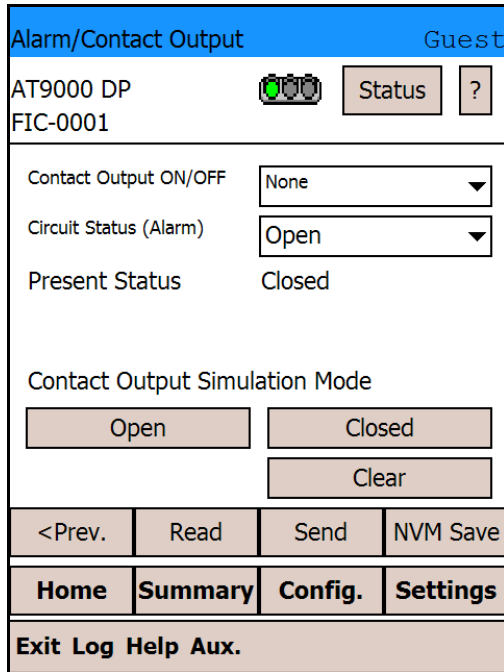

- (6) Tap the “Contact Output ON/OFF” drop-down menu, and a list of alternative reflections on contact outputs will appear. Select the desired contact output.

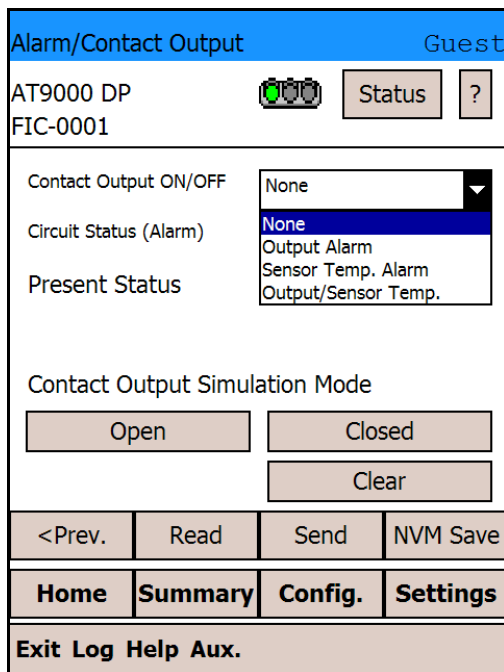

Configure the contact output upon detection of an alarm condition in the same way.

- (7) Tap [Send] to transmit the set value to the device.

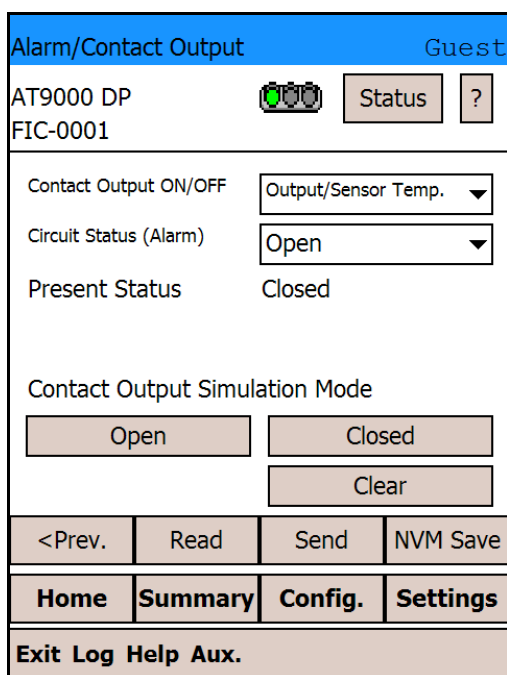

If you might need to turn off the power of the device within 30 seconds after the transmission of the data, tap [NVM Save] to save your changes.

- (8) To set the “Contact Output” to “Open,” tap [Open]. A confirmation message appears. Tap [Yes].

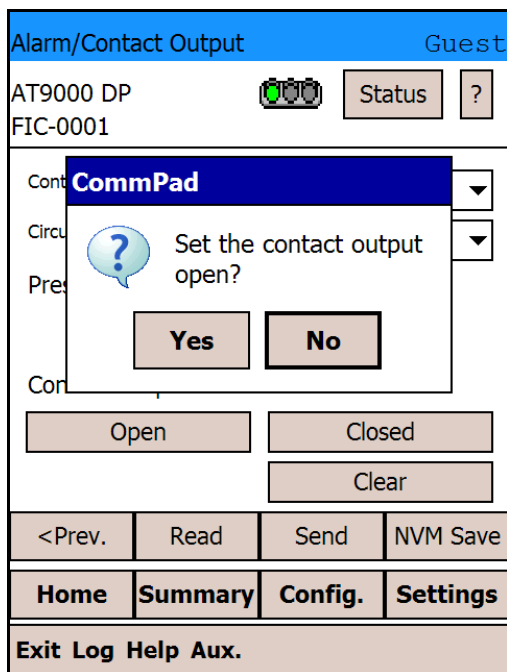

- (9) The device is now in Contact Output Simulation Mode, and the traffic light icon changes to yellow. In addition, the current status of Contact Output is displayed by the Present Status. The [Open] or [Closed] button will become bold also.

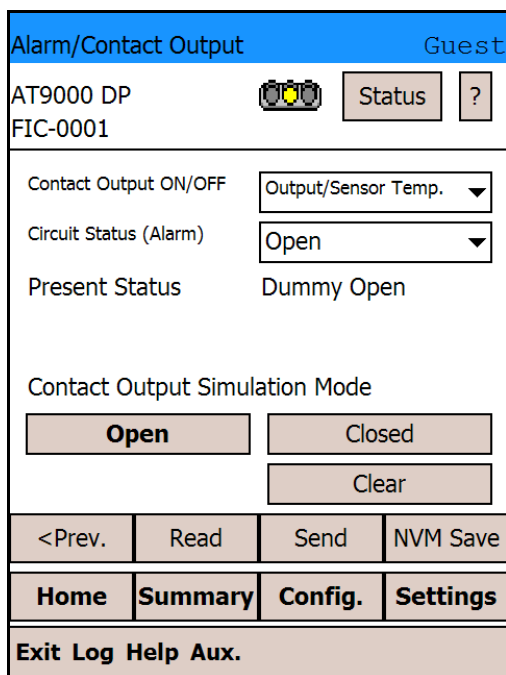

To set the “Contact Output” to “Close,” use the same procedure.

- (10) To clear the Contact Output Simulation Mode, tap [Clear]. A confirmation message appears. Tap [Yes].

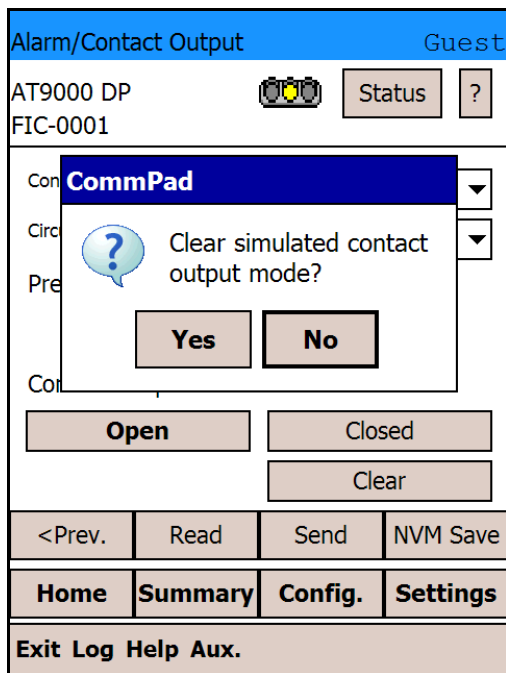

The Contact Output Simulation Mode is now cleared. Note that even if you do not clear the Contact Output Simulation Mode, the device will automatically clear it after approximately 10 minutes without communication.

- (11) If you try to move from the Alarm/Contact Output screen to another screen without first clearing the Contact Output Simulation Mode, the confirmation message “Clearing simulated contact output mode and proceeding to the specified screen.” appears. Tap [OK], and the Contact Output Simulation Mode is cleared and you will move to another screen.

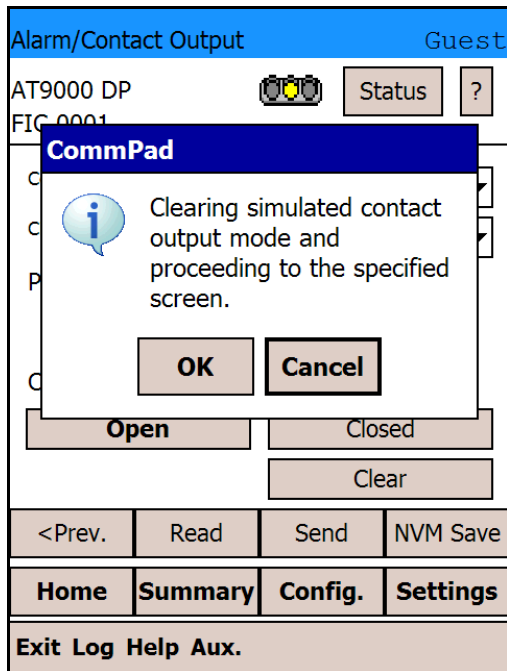

4.33: Data Overwrite Protection

This function protects the settings of the device.

If this function is enabled, the settings of the device cannot be changed.

This function is provided by the software and hardware.

The current value is displayed. Tap the “Write protect” drop-down menu, and write protect Off/On selections will appear. Select the “Off” or “On” and tap [Send].

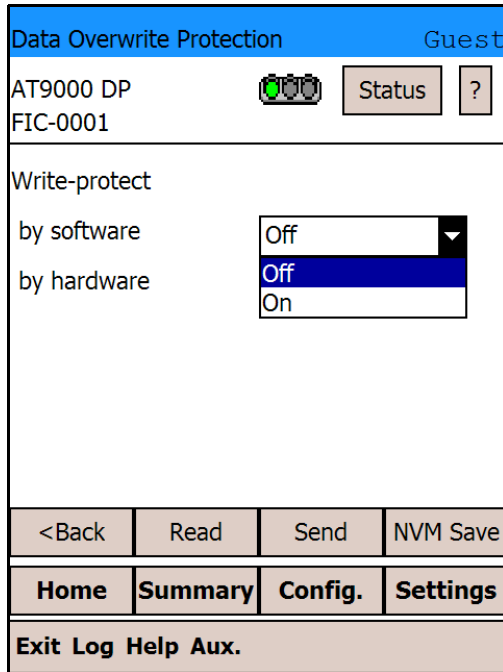

If you might need to turn off the power of the device within 30 seconds after the transmission of the data, tap [NVM Save] to save your change. Tapping [Read] reads the set values and displays them again. Tapping [<Back] restores the original screen.

4.34: Settings screen

You can view the data list for the device on this screen. You can also save data and view previously saved data.

- (1) Tap [Settings], and a confirmation message will appear. Tap [Yes].

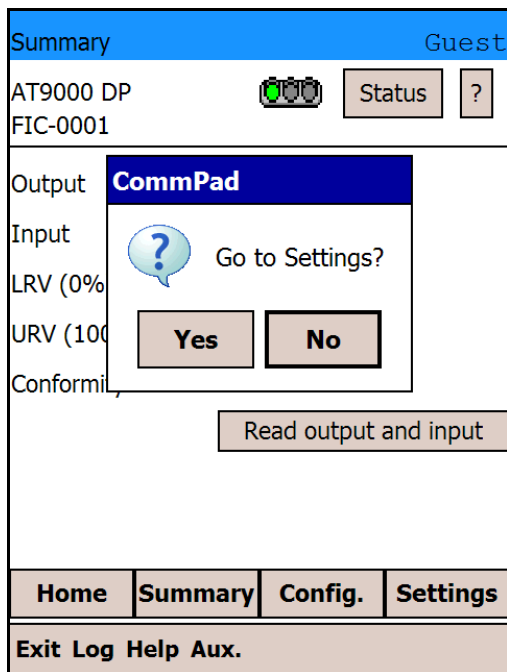

- (2) After communication with the device is complete, the data is listed. Use the scroll bar on the right of the screen to scroll down and view all the data.

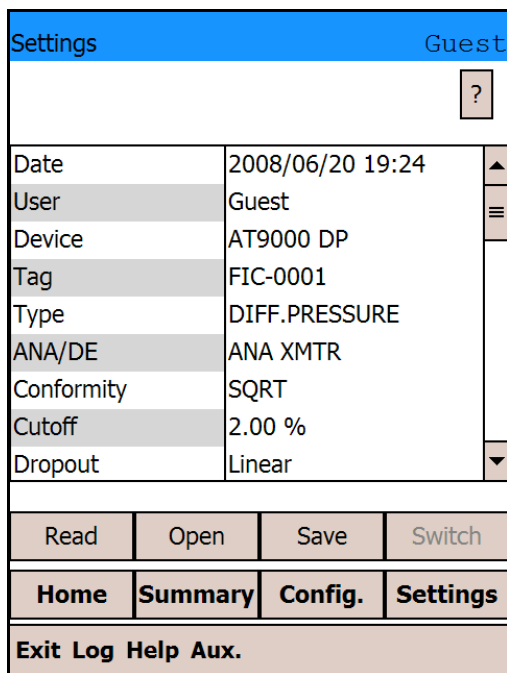

- (3) You can also compare previously saved data with the latest data. For example, if you save data before performing an operation, by tapping [Open] and selecting the previously saved data, you can compare the data before and after the operation to see what has changed. Any values that have been changed are highlighted in yellow.

For information on how to save data, see chapter 5, “Saving Data.”
Tap [Open].

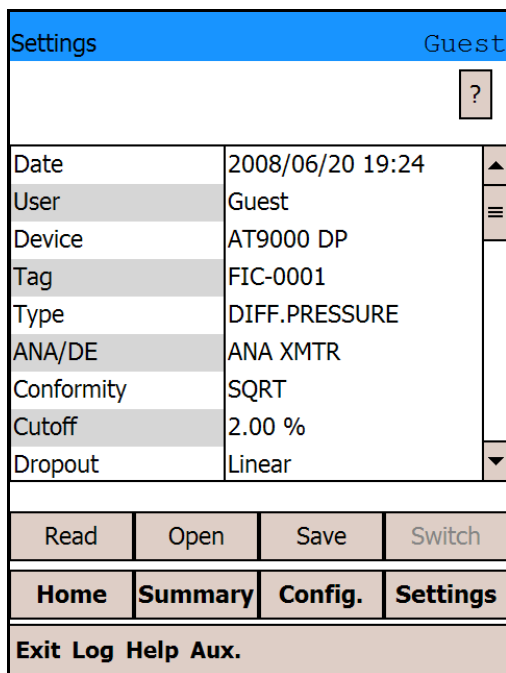

- (4) The “Open” screen appears. Tap the name of the file you saved before the operation.

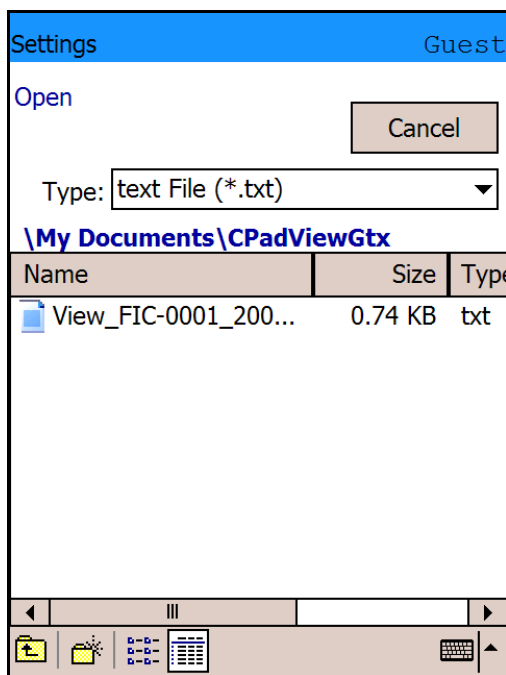

- (5) The data you saved before the operation is displayed on the right side of the screen. Any values that have changed are highlighted in yellow, so they can be easily spotted.

Settings		Guest				
		?				
Date	2008/06/20 19:35	2008/06/20 19:24				
User	Guest	Guest				
Device	AT9000 DP	AT9000 DP				
Tag	FIC-0001	FIC-0001				
Type	DIFF.PRESSURE	DIFF.PRESSURE				
ANA/DE	ANA XMTR	ANA XMTR				
Conformity	SQRT	SQRT				
Cutoff	2.00 %	2.00 %				
Dropout	Linear	Linear				
<table border="1"> <tr> <td>Read</td> <td>Open</td> <td>Save</td> <td>Switch</td> </tr> </table>			Read	Open	Save	Switch
Read	Open	Save	Switch			
<table border="1"> <tr> <td>Home</td> <td>Summary</td> <td>Config.</td> <td>Settings</td> </tr> </table>			Home	Summary	Config.	Settings
Home	Summary	Config.	Settings			
Exit Log Help Aux.						

- (6) Use the scroll bar on the right of the screen to scroll down and view all the data.

Settings		Guest				
		?				
Flow Mode	Bi-Dir.	Bi-Dir.				
PROM No.	2805337900	2805337900				
S/W Version	3.0	3.0				
Damping	0.16 s	0.16 s				
Span	100.00 kPa	86.34 kPa				
LRV (0%)	0.0000 kPa	19.927 kPa				
URV (100%)	100.00 kPa	106.27 kPa				
URL	99.64 kPa	99.64 kPa				
F/S Dir.	Downscale	Downscale				
<table border="1"> <tr> <td>Read</td> <td>Open</td> <td>Save</td> <td>Switch</td> </tr> </table>			Read	Open	Save	Switch
Read	Open	Save	Switch			
<table border="1"> <tr> <td>Home</td> <td>Summary</td> <td>Config.</td> <td>Settings</td> </tr> </table>			Home	Summary	Config.	Settings
Home	Summary	Config.	Settings			
Exit Log Help Aux.						

(7) Tap [Switch] to switch to a screen that displays only the current values. Tap [Read] to reread and redisplay the data. For more information, please refer to the CommPad User's Manual (Common Edition).

Tap [Switch] to switch to a screen that displays only the current values. Tap [Read] to reread the displayed data and redisplay it.

Settings		Guest				
		?				
Date	2008/06/20 19:35	▲				
User	Guest	☰				
Device	AT9000 DP					
Tag	FIC-0001					
Type	DIFF.PRESSURE					
ANA/DE	ANA XMTR					
Conformity	SQRT					
Cutoff	2.00 %					
Dropout	Linear	▼				
<table border="1" style="width: 100%;"> <tr> <td>Read</td> <td>Open</td> <td>Save</td> <td>Switch</td> </tr> </table>			Read	Open	Save	Switch
Read	Open	Save	Switch			
<table border="1" style="width: 100%;"> <tr> <td>Home</td> <td>Summary</td> <td>Config.</td> <td>Settings</td> </tr> </table>			Home	Summary	Config.	Settings
Home	Summary	Config.	Settings			
Exit Log Help Aux.						

Section 5 : Saving Data

The transmitter data loaded into CommPad can be saved in CommPad's internal memory.

CAUTION

After starting communication with CommPad, if you adjust the zero/span point using the external zero/span adjustment function, only the data in the transmitter will be changed, leaving a data inconsistency between the transmitter and CommPad. After manual zero adjustment you must go to Home screen and tap [Start], to eliminate the data inconsistency.

Saving Data from the View Screen

- (1) Tap [Settings], and a confirmation message will appear. Tap [Yes].

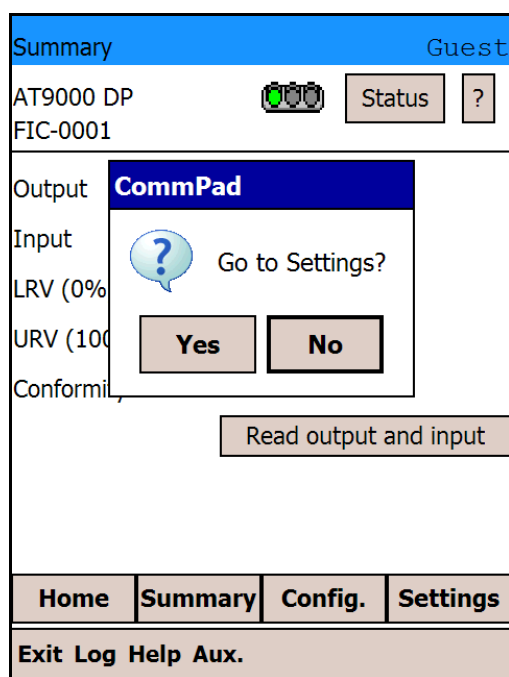

- (2) After communication with the transmitter is complete, the data is listed. Use the scroll bar on the right of the screen to scroll down and view all the data.

Settings		Guest	
		?	
Date	2008/06/20 19:24	▲	
User	Guest	≡	
Device	AT9000 DP		
Tag	FIC-0001		
Type	DIFF.PRESSURE		
ANA/DE	ANA XMTR		
Conformity	SQRT		
Cutoff	2.00 %		
Dropout	Linear	▼	
Read	Open	Save	Switch
Home	Summary	Config.	Settings
Exit Log Help Aux.			

- (3) By tapping [Save], you can save the displayed data to a file. The file name is supplied automatically. Tap [OK] without changing anything. The name of the automatically-named file has the following structure:

View_(tag name)_(year/month/day/hour/minute).txt

The designated folder is: CPadViewGtx

If either of the following 2 characters that cannot be used in a Windows file name is contained in the tag name, the character(s) will be converted automatically as indicated:

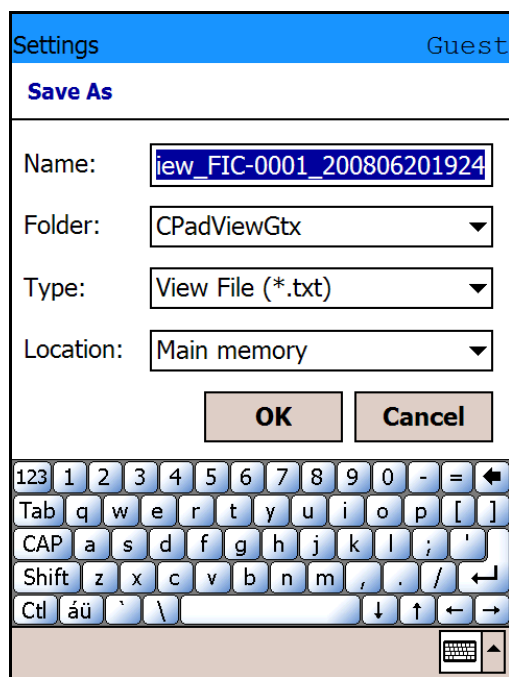

Character	Replacement
. (dot)	_ (underscore)
/ (slash)	~ (tilde)

(4) A confirmation message appears. Tap [ok].

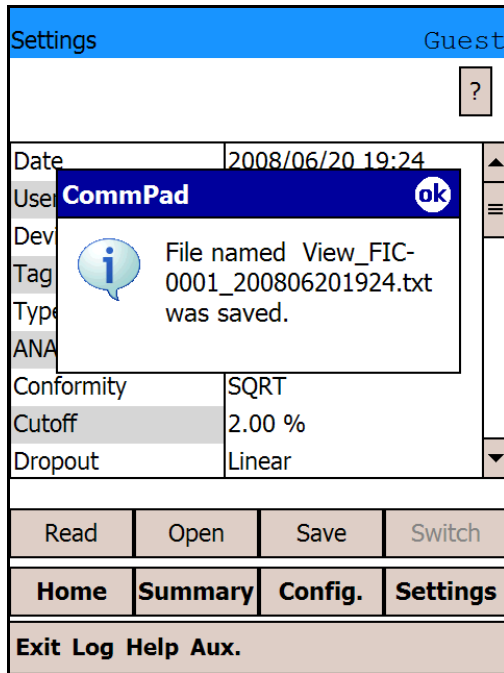

(5) The listed data has now been saved to a file.

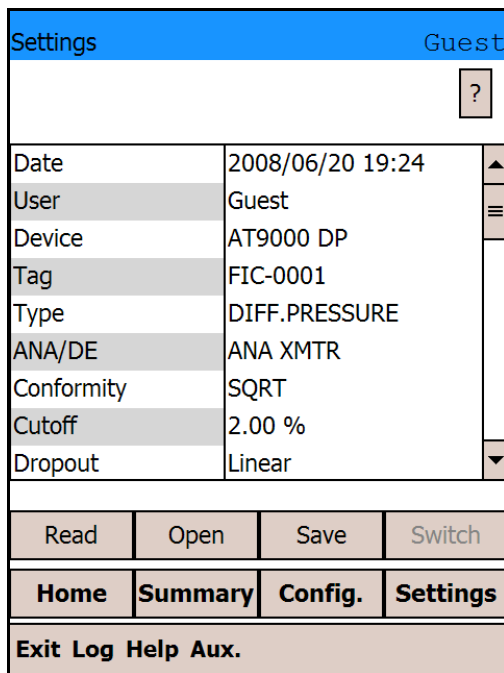

The saved file can be copied to your PC and viewed there. The data will look like the example shown below. Since the file is in a CSV text format, in which the item names and the values are separated by commas, you can read the file with Excel or similar software.

```
CommPad view file
Date, 2007/08/31 16:43
User,Guest
Device,AT9000 DP
Tag,FIC-0001
Type,DIFF.PRESSURE
ANA/DE, ANA XMTR
Conformity,Linear
PROM No.,2737662307
S/W Version,1.0
Damping,1 s
Span,50.00 kPa
LRV (0%),0.0000 kPa
URV (100%),50.00 kPa
URL,100.00 kPa
F/S Dir.,Downscale
Standard,None
Display,Linear
Disp. Unit,Actual Pressure
O.L.LO,-2.500 %
O.L.HI,110.00 %
Output Alarm,Upper/Lower Limit
:
:
Present Status,Closed
Write-protect by software,Off
Write-protect by hardware,Off
Output,0.00 %
Input,0.0019 kPa
Sensor Temp.,26.1 °C
Status,Status OK
```

Section 6 : Troubleshooting

The following describes the meaning of the status messages and the related troubleshooting procedures.

	Status message	Meaning	Required action
Internal data inconsistency	Invalid database	Configuration data and/or calibration data is corrupt.	Tap [Exit] and try communicating again. Verify configuration data and recalibrate the device.
Critical status	Analog/Digital Conversion Fault	Analog/Digital conversion failure	Invalid sensor and/or electronics board. Contact appropriate personnel.
	Sensor Characteristic Data Fault	Sensor characteristic data failure	Contact appropriate personnel.
	Suspect Input	Input data error	Invalid sensor and/or electronics board. Contact appropriate personnel.
	CPU Fault	CPU operation failure	Bad electronics board. Contact appropriate personnel.
	NVM Fault	Nonvolatile memory failure	Bad electronics board. Contact appropriate personnel.
	RAM Fault	RAM failure	Bad electronics board. Contact appropriate personnel.
	ROM Fault	ROM failure	Bad electronics board. Contact appropriate personnel.
	Output Circuit Fault	Output circuit failure	Bad electronics board. Contact appropriate personnel.
Non-critical status	Meter Body Over Temperature	Meter body temperature is too high.	Reinstall the device to decrease the temperature to within specifications.
	Excess Zero Correct	The zero correction factor is outside the acceptable limits for accurate operation.	Check the input and be sure it matches the calibrated range value.
	Excess Span Correct	The span correction factor is outside the acceptable limits for accurate operation.	Check the input and be sure it matches the calibrated range value.
	In Output Mode	The device is operating in output mode.	Go to the output mode menu to clear the output mode.
	Meter Body Overload or Meter Body Fault	- The input pressure is more than two times The upper range limit for The device. - Device error.	Check the PV value and replace the device with a larger range model if necessary.
	Correct Reset	Calibration data is cleared.	Calibrate the lower and upper range values.
	External Zero/Span Adjustment Fault	External zero/span adjustment error.	Contact appropriate personnel.
	Contact Output Simulation Mode	The device is operating contact output simulation mode.	To clear contact output simulation mode, go to the alarm/contact output menu.
	Output Alarm Detected	The output is going over upper/lower limit of output alarm.	Check the output.
	Sensor Temp. Alarm Detected	The sensor temperature is going over upper/lower limit of sensor temp. alarm.	Check the sensor temperature.

Appendix B - Damping time constant related calibration span when shipped

Unless specified in order, damping time constant related calibration span is following table.

Model	Calibration span / damping time constant		
	1sec	2sec	4sec
GTX30A	From 5kPa	4kPa to 5kPa	-
GTX40A	From 210kPa	80kPa to 210kPa	35kPa to 80kPa
GTX35F	From 5kPa	2.5kPa to 5kPa	-
GTX60F	From 210kPa	80kPa to 210kPa	70kPa to 80kPa
GTX15D	-	0.1kPa to 2kPa	-
GTX30D/31D	From 5kPa	2.5kPa to 5kPa	0.75kPa to 2.5kPa
GTX32D	From 5kPa	2.5kPa to 5kPa	0.75kPa to 2.5kPa
GTX41D	From 90kPa	45kPa to 90kPa	35kPa to 45kPa
GTX42D	From 90kPa	45kPa to 90kPa	35kPa to 45kPa
GTX71D	From 1.4MPa	0.7MPa to 1.4MPa	0.25MPa to 0.7MPa
GTX72D	From 1.4MPa	0.7MPa to 1.4MPa	0.25MPa to 0.7MPa
GTX35R	From 5kPa	2.5kPa to 5kPa	-
GTX40R	From 90kPa	45kPa to 90kPa	35kPa to 45kPa
GTX60G	From 210kPa	80kPa to 210kPa	35kPa to 80kPa
GTX71G	From 1.4MPa	0.7MPa to 1.4MPa	-
GTX82G	From 1MPa	0.7MPa to 1MPa	-
GTX35U	From 5kPa	2.5kPa to 5kPa	-
GTX60U	From 210kPa	80kPa to 210kPa	35kPa to 80kPa
GTX71U	From 1.4MPa	0.7MPa to 1.4MPa	-
GTX82U	From 1MPa	0.7MPa to 1MPa	-
GTX30S	From 5kPa	4kPa to 5kPa	-
GTX60S	From 210kPa	80kPa to 210kPa	35kPa to 80kPa

MEMO

Appendix C - General Specifications

Measuring span / Setting range / Working pressure range

Model	Measuring Span	Measuring range	Working Pressure Range
GTX 15D	0.1 to 2 kPa {10 to 200 mmH ₂ O}	-1 to 1 kPa {-100 to 100 mmH ₂ O}	-70 to 210 kPa {-0.7 to 2.1 kgf/cm ² }
GTX 30D	0.5 to 100 kPa {50 to 10160 mmH ₂ O}	-100 to 100 kPa {-10160 to 10160 mmH ₂ O}	2.0kPa abs to 3.5MPa {15 mmHg abs to 35 kgf/cm ² } *Note 1
GTX 31D	0.5 to 100 kPa {50 to 10160 mmH ₂ O}	-100 to 100 kPa {-10160 to 10160 mmH ₂ O}	2.0 kPa abs to 21 MPa {15 mmHg abs to 210 kgf/cm ² } *Note 1, *Note 2 (For vacuum pressure, see Figure 2, 3)
GTX 32D	0.5 to 100 kPa {50 to 10160 mmH ₂ O}	-100 to 100 kPa {-10160 to 10160 mmH ₂ O}	2.0 kPa abs to 42 MPa {15mmHg abs to 420 kgf/cm ² } *Note 3 (For vacuum pressure, see Figure 2, 3)
GTX 40D	35 to 700 kPa {0.35 to 7kgf/cm ² }	-100 to 700 kPa {-1 to 7kgf/cm ² }	2.0kPa abs to 3.5MPa {15 mmHg abs to 35 kgf/cm ² } *Note 1
GTX 41D	35 to 700 kPa {0.35 to 7kgf/cm ² }	-100 to 700 kPa {-1 to 7kgf/cm ² }	2.0 kPa abs to 21 MPa {15 mmHg abs to 210 kgf/cm ² } *Note 1, *Note 2 (For vacuum pressure, see Figure 2, 3)
GTX 42D	35 to 700 kPa {0.35 to 7kgf/cm ² }	-100 to 700 kPa {-1 to 7kgf/cm ² }	2.0 kPa abs to 42 MPa {15mmHg abs to 420 kgf/cm ² } *Note 3 (For vacuum pressure, see Figure 2, 3)
GTX 71D	0.25 to 14MPa {2.5 to 140kgf/cm ² }	-0.1 to 14 MPa {-1 to 140 kgf/cm ² }	2.0 kPa abs to 21 MPa {15 mmHg abs to 210 kgf/cm ² } *Note 1, *Note 2 (For vacuum pressure, see Figure 2, 3)
GTX 72D	0.25 to 14MPa {2.5 to 140kgf/cm ² }	-0.1 to 14 MPa {-1 to 140 kgf/cm ² }	2.0 kPa abs to 42 MPa {15mmHg abs to 420 kgf/cm ² } *Note 3 (For vacuum pressure, see Figure 2, 3)

- Note) 1) With PVC wetted parts, the maximum working pressure is 1.5 MPa {15 kgf/cm²}.
 2) With 304 SST bolts and nuts, the maximum working pressure is 10MPa {100 kgf/cm²}.
 3) With 304 SST bolts and nuts, the maximum working pressure is 23 MPa {234 kgf/cm²}.

Model	Measuring Span	Measuring range	Overload Resistance value
GTX 60G	17.5 to 3500 kPa {0.175 to 35 kgf/cm ² }	-100 to 3500 kPa {-1 to 35 kgf/cm ² } (Note 1)	5250 kPa {52.5 kgf/cm ² }
GTX 71G	0.7 to 14 MPa {7 to 140 kgf/cm ² }	-0.1 to 14 MPa {-1 to 140 kgf/cm ² } (Note 2)	21 MPa {210 kgf/cm ² }
GTX 82G	0.7 to 42 MPa {7 to 420 kgf/cm ² }	-0.1 to 42 MPa {-1 to 420 kgf/cm ² } (Note 3)	63 MPa {630 kgf/cm ² }

- Note) 1) With PVC parts, the maximum working pressure is 1.5 MPa {15 kgf/cm²}.
 2) With 304 SST bolts and nuts, the maximum working pressure is 10MPa {100 kgf/cm²}.
 3) With 304 SST bolts and nuts, the maximum working pressure is 23 MPa {234 kgf/cm²}.

	Measuring Span	Setting Range	Working Pressure Range	Overload Resistant Value
GTX 30A	4 to 104 kPa abs {30 to 780 mmHg abs}	0 to 104 kPa abs {0 to 780 mmHg abs}	0.01 to 104 kPa abs {0.1 to 780 mmHg abs} See Figure 6	300 kPa abs {3.0 kgf/cm ² abs}
GTX 60A	35 to 3500 kPa abs {0.35 to 35 kgf/cm ² abs}	0 to 3500kPa abs {0 to 35 kgf/cm ² abs}	0.01 to 3500 kPa abs {0.1 mmHg abs to 35 kgf/cm ² abs} See Figure 6	5250 kPa abs {52.5 kgf/cm ² abs}

Note) With PVC wetted parts, the maximum working pressure is 1.5 MPa {15 kgf/cm²}.

	Measuring span	Setting range	Working pressure range
GTX 35F	2.5 to 100kPa {250 to 10160 mmH ₂ O}	-100 to 100kPa {-10160 to 10160 mmH ₂ O}	Up to flange rating (for negative pressures, see Figure 2 and Figure 3)
GTX 60F	35 to 3500kPa {0.35 to 35 kgf/cm ² }	-100 to 3500kPa {-1~35 kgf/cm ² }	

	Measuring Span	Setting Range	Working Pressure Range
GTX 35R	2.5 to 100 kPa {250 to 10160 mmH ₂ O}	-100 to 100 kPa {-10160 to 10160 mmH ₂ O}	Up to flange rating (For negative pressures, see Figure 7, Figure 8 and Figure 9.)
GTX 40R	35 to 700 kPa {0.35 to 7 kgf/cm ² }	-100 to 700 kPa {-1 to 7 kgf/cm ² }	

	Measuring Span	Setting Range	Working Pressure Range	Overload Resistant Value
GTX 35U	2.5 to 100 kPa {250 to 10160 mmH ₂ O}	-100 to 100 kPa {-10160 to 10160 mmH ₂ O}	Up to flange rating (For negative pressures, see Figure 7, Figure 8 and Figure 9.)	None
GTX 60U	35 to 3500 kPa {0.35 to 35kgf/cm ² }	-100 to 3500 kPa {-1 to 35 kgf/cm ² }	Up to flange rating (For negative pressures, see Figure 7, Figure 8 and Figure 9.)	5250 kPa {52.5 kgf/cm ² }
GTX 71U	0.7 to 10 MPa {7 to 102 kgf/cm ² }	-0.1 to 10 MPa {-1 to 102 kgf/cm ² }	Up to flange rating (For negative pressures, see Figure 7, Figure 8 and Figure 9.)	15.3 MPa {153 kgf/cm ² }
GTX 82U	0.7 to 42 MPa {7 to 420 kgf/cm ² }	-0.1 to 42 MPa {-1 to 420 kgf/cm ² }	Up to flange rating (For negative pressures, see Figure 7, Figure 8 and Figure 9.)	63MPa {630 kgf/cm ² }

	Measuring span	Setting range	Working pressure range	Overload resistant value
GTX 30S	4 to 104 kPa abs. {30 to 780 mmHg abs.}	0 to 104 kPa abs. {0 to 780 mmHg abs.}	0.13 to 104 kPa abs.	300 kPa abs. {3.0 kgf/cm ² }
GTX 60S	35 to 3500 kPa abs. {0.35 to 35 kgf/cm ² abs.}	0 to 3500 kPa abs. {0 to 35 kgf/cm ² abs.}	Up to flange rating of the setting range, which is lower.	5250 kPa abs. {52.5 kgf/cm ² }

Supply voltage and load resistance

17.9 to 42V DC. A load resistance of 250 Ω or more is necessary between loops. See Figure 1.

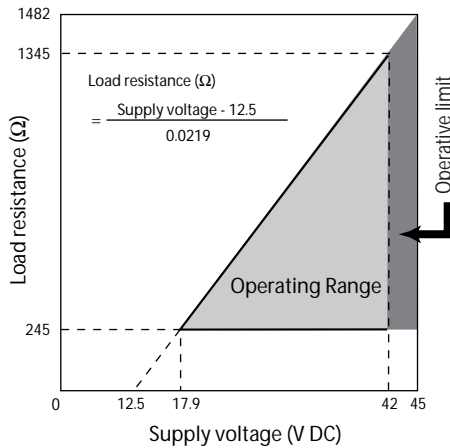

Figure 1 Supply voltage vs. load resistance characteristics

Note For communication with HART communicator or Comm-Pad, a load resistance of 250 Ω or more is necessary.

Output

Analog output (4 to 20 mA DC) with DE protocol
Analog output (4 to 20 mA DC) with HART protocol

Output signal

3.6 to 21.6 mA
3.8 to 20.5 mA (NAMUR NE43 compliant)

Failure Alarm

Upper: 21.6 mA or more
Lower: 3.6 mA or less

Ambient humidity limits

5 to 100% RH

Stability against supply voltage change

± 0.005% FS/V

Damping time

Selectable from 0 to 32 sec. in ten stages

Lightning protection

Applicable Standards; IEC 61000-4-5
Peak value of current surge(80/20μ sec.): 6000A

Indicator

The digital LCD indicator (optional) indicates engineering units and can be set freely between -99999 and 99999 (5 digits). For meter calibration, specify the following items when placing your order

- Meter calibration range
- Meter calibration unit
- Linear / Square-root for meter indication.

Various kinds of data can be set using the CommPad or the HART[®]375 communicator.

Bolts and nuts materials (for fastening meter body cover)

Carbon steel (SNB7), 304 SST, 630 SST

Paint

Standard

Corrosion-resistant paint (Baked acrylic paint)

Corrosion-proof finish

Corrosion-proof paint (Baked epoxy paint), fungus-proof finish

Corrosion-resistant finish (silver paint)

Transmitter case is coated with silver paint in addition to the above corrosion-resistant finish.

Ambient temperature limit

GTX__D

Normal operating range

-40 to 85°C for general purpose models
-15 to 65°C for general purpose model (model GTX15D)
-15 to 85°C for general purpose model (model GTX32D/42D/72D)
-10 to 75°C for oxygen and chlorine models
-10 to 65°C for oxygen and chlorine model (model GTX15D)
-25 to 80°C for model with digital indicators
-15 to 65°C for model with digital indicators (model GTX15D)
-15 to 80°C for model with digital indicators (model GTX132D/42D/72D)

Operative limits

-50 to 93°C for general purpose models
-40 to 70°C for general purpose model (model GTX15D)
-25 to 93°C for general purpose model (model GTX32D/42D/72D)
-40 to 80°C for oxygen and chlorine models
-30 to 85°C for models with digital indicators
-40 to 70°C for models with digital indicators (model GTX15D)
-25 to 85°C for models with digital indicators (model GTX132D/42D/72D)

Transportation and storage conditions

-50 to 85°C for general purpose models
-15 to 65°C for general purpose model (model GTX15D)
-15 to 85°C for general purpose model (model GTX32D/42D/72D)

GTX__G,__A

Normal operating range

-40 to 85°C for general purpose models
-10 to 75°C for oxygen and chlorine models
-25 to 80°C for models with digital indicators

Operative limits

-50 to 93°C for general purpose models
-40 to 80°C for oxygen and chlorine models
-30 to 85°C for models with digital indicators

Transportation and storage conditions

-50 to 85°C

GTX__ F**Normal operating range**

- 30 to 75°C for general purpose models
- 10 to 75°C for oxygen and chlorine models
- 25 to 75°C for models with digital indicators

Operative limits

- 50 to 80°C for general purpose models
- 40 to 80°C for oxygen and chlorine models
- 30 to 80°C for models with digital indicators

Transportation and storage conditions

- 50 to 85°C

Temperature ranges of wetted parts**GTX__ D****Normal operating range**

- 40 to 110°C for general purpose models
- 15 to 65°C for general purpose model (model GTX15D)
- 15 to 110°C for general purpose model (model GTX32D/42D/72D)
- 20 to 75°C for oxygen and chlorine models
- 15 to 65°C for oxygen and chlorine model (model GTX15D)
- 15 to 75°C for oxygen and chlorine model (model GTX32D/42D/72D)

Operative limits

- 50 to 115°C for general purpose models
- 40 to 70°C for general purpose model (model GTX15D)
- 20 to 115°C for general purpose model (model GTX32D/42D/72D)
- 40 to 80°C for oxygen and chlorine models
- 40 to 70°C for oxygen and chlorine models (model GTX15D)
- 20 to 80°C for oxygen and chlorine models (model GTX32D/42D/72D)

GTX__ G, __ A, __ F**Normal operating range**

- 40 to 110°C for general purpose models
- 20 to 75°C for oxygen and chlorine models

Operative limits

- 50 to 115°C for general purpose models
- 40 to 80°C for oxygen and chlorine models

Table 1: GTX__R,__U

Ambient temperature limits / Temperature ranges of wetted parts: Flange size: 4 inches (100mm), 3 inches (80mm), 2 inches (50mm), 1.5 inches (40mm)

		Temperature range (°C) *1 *4				
		Regular type	High-temp. models	High-temp. Vacuum models	High-temp. High Vacuum models	Oxygen and Chlorine models
Wetted parts section	Normal operating range	-40 to 180	-5 to 280 *5	-5 to 280 *5	10 to 300 *5	-10 to 120
	Operative limit range	-50 to 185	-10 to 310 *6	-10 to 310 *6	-10 to 310 *6	-40 to 125
Ambient temperature *2 Flange size: Flush diaphragm type 3 inches (80 mm) Extended diaphragm type 4 inches (100 mm)	Normal operating range	-30 to 75	-5 to 55	-5 to 55	10 to 55	-10 to 75
	Operative limit range	-50 to 80	-10 to 60	-10 to 60	-10 to 60	-40 to 80
Ambient temperature Note 2 Flange size: Flush diaphragm type 2 inches (50 mm) / 1.5 inch (40 mm) Extended diaphragm type 3 inches (80 mm) / 2 inches (50 mm)	Normal operating range	-15 to 65	-5 to 45	-5 to 55	10 to 55	-10 to 75
	Operative limit range	-30 to 80	-10 to 55	-10 to 60	-10 to 60	-40 to 80
Specific gravity of fill liquid *3		0.935	1.07	1.07	1.09	1.87

Note) *1: See the working pressures and temperatures of the wetted parts section in Figure 7, Figure 8 and Figure 9. *2: Ambient temperatures of the transmitter itself *3: Approximate values at the temperature of 25°C *4: Note that if the operating temperature falls below the lower limit of the normal operating range, the response of the transmitter becomes slower. *5: When the wetted parts material is tantalum, the upper limit is 180°C. *6: When the wetted parts material is tantalum, the upper limit is 200°C

Table 2: GTX__R,__U

Ambient temperature limits / Temperature ranges of wetted parts: Flange size: 3/4inches (20mm), 1/2 inches (15mm)

		Temperature range (°C) *1 *4			
		Regular type	High-temp. models	Oxygen and chlorine models	Fast response models
Wetted parts section	Normal operating range	-40 to 180	-5 to 280	-10 to 120	-40 to 120
	Operative limit range	-50 to 185	-10 to 310	-40 to 125	-50 to 125
Ambient temperature *2	Normal operating range	-15 to 65	-5 to 45	-10 to 75	-15 to 65
	Operative limit range	-30 to 80	-10 to 55	-40 to 80	-30 to 80
Specific gravity of fill liquid *3		0.935	1.07	1.87	0.873

Note) *1: See the working pressures and temperatures of the wetted parts section in Figure 7, Figure 8, and Figure 9. *2: Ambient temperatures of the transmitter itself. *3: Approximate values at the temperature of 25°C. *4: Note that if the operating temperature falls below the lower limit of the normal operating range, the response of the transmitter becomes slower.

Table 3: GTX__S

Ambient temperature limits / Temperature ranges of wetted parts:

		Temperature Range (°C) *1 *4	
		High-temp. vacuum models	High-temp. high-vacuum models
Wetted parts section	Normal operating range	-5 to 280	10 to 300
	Operative limit range	-10 to 310	-10 to 310
Ambient temperature *2	Normal operating range	-5 to 55	10 to 55
	Operative limit range	-10 to 60	-10 to 60
Specific gravity of fill liquid *3		1.07	1.09

Note) *1: See the working pressures and temperatures of the wetted parts section in Figure 7, Figure 8 and Figure 9. *2: Ambient temperatures of the transmitter itself *3: Approximate values at the temperature of 25°C *4: Note that if the operating temperature falls below the lower limit of the normal operating range, the response of the transmitter becomes slower.

For Explosion proof models with digital indicators, which have to be used within the following ranges

Normal operating condition

-20 to 70°C

Operative limit

-30 to 80°C

Working pressure and temperature of wetted parts section

GTX__D, __G, __F ,

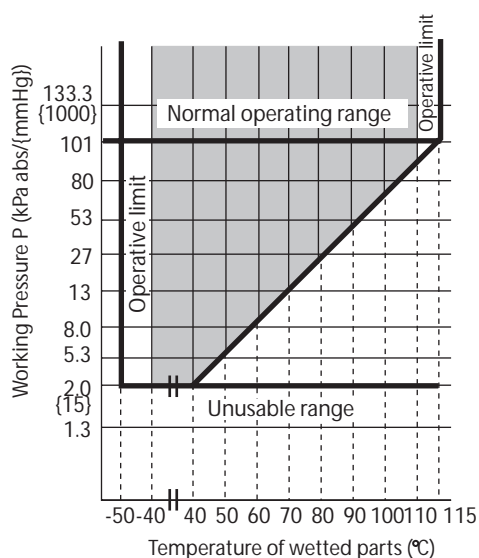

Figure 2 Working pressure and temperature of wetted parts section (for general purpose models)

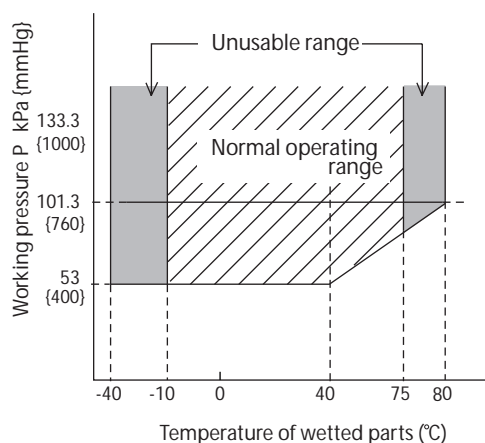

Figure 3 Working pressure and temperature of wetted parts section (for oxygen and chlorine service)

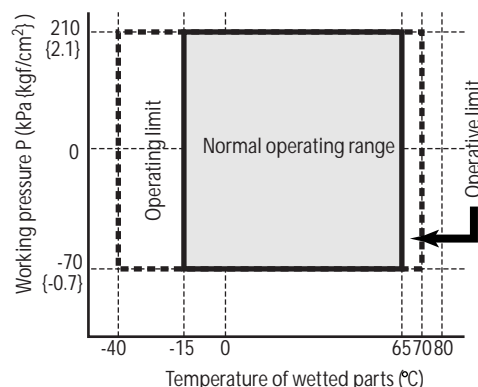

Figure 4 Working pressure and temperature of wetted parts section (for model GTX15D regular type)

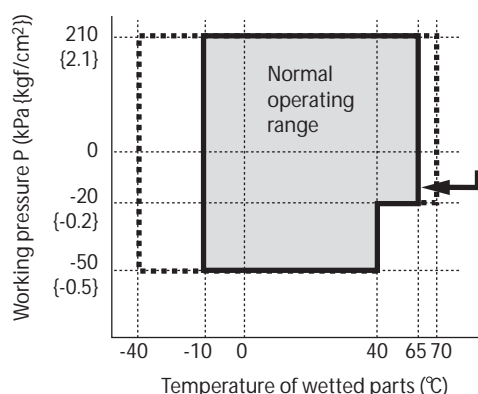

Figure 5 Working pressure and temperature of wetted parts section (for model GTX15D oxygen service)

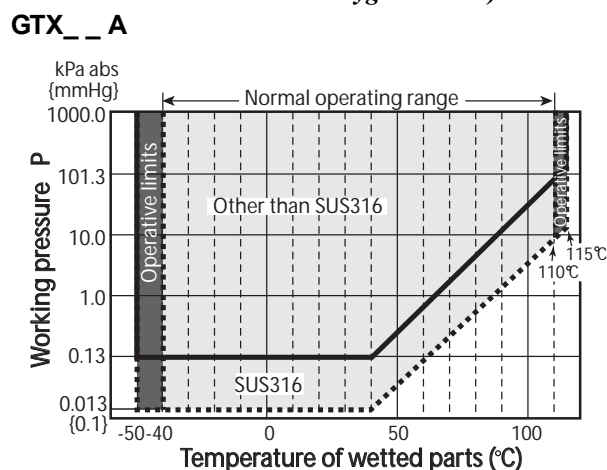

Figure 6 Working pressure and temperature of wetted parts section (for general purpose models)

GTX__R,__U

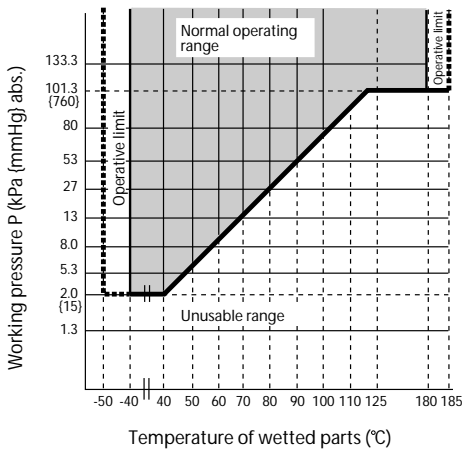

Figure 7 Working pressure and temperature of wetted parts section (for general purpose models)

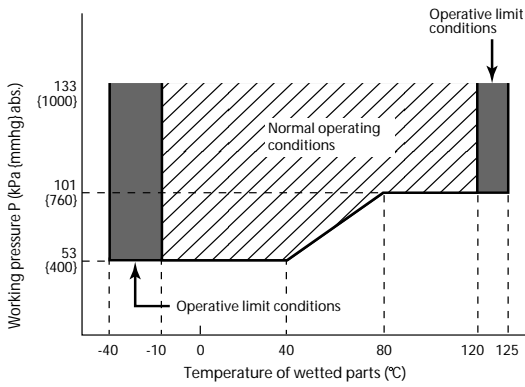
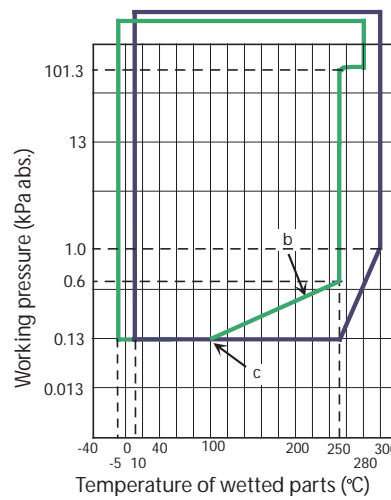

Figure 8 Working pressure and temperature wetted parts section (for oxygen and chlorine service)

GTX__S



- b. For high temperature and vacuum,
- c. For high temperature and high vacuum

Figure 10 Working pressure temperature of wetted parts section (For high temperature and vacuum / high temperature and high vacuum)

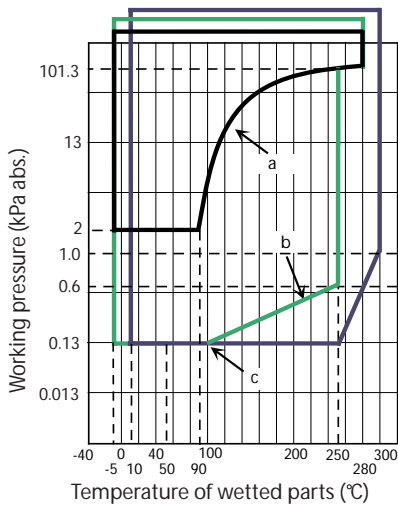

- a. For high temperature
- b. For high temperature and vacuum,
- c. For high temperature and high vacuum

Figure 9 Working pressure temperature of wetted parts section (For high temperature / high temperature and vacuum / high temperature and high vacuum)

Ambient temperature and temperature of wetted parts section

GTX__R,__U

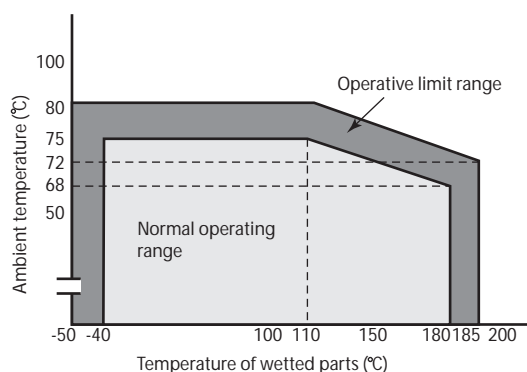

Figure 11 Ambient temperature and temperature of wetted parts section (for general purpose models)

[Flange diameter: Flush diaphragm 2 inches (50 mm) / 1.5 inch (40 mm)
Extended diaphragm 3 inches (80 mm) / 2 inches (50 mm)]

Note) When the fill liquid is for general purposes, make sure before using your transmitter that the conditions in both Figure 7, Figure 11 and Figure 12 are met.

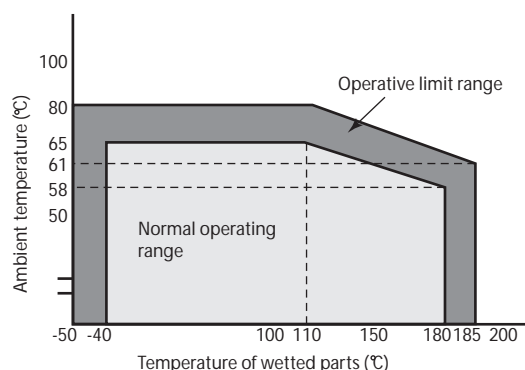

Figure 12 Ambient temperature and temperature of wetted parts section (for general purpose models)

[Flange diameter: Flush diaphragm 3 inches (80 mm)
Extended diaphragm 4 inches (100 mm)]

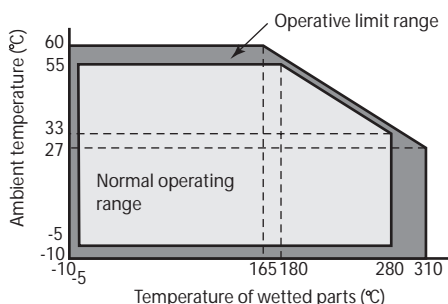

Figure 13 Ambient temperature and temperature of wetted parts section (for high temperature and vacuum 2, 3 m)

[Flange diameter: Flush diaphragm 2 inches (50 mm) / 1.5 inch (40 mm)]

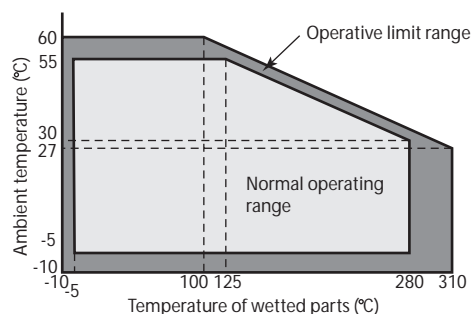

Figure 14 Ambient temperature and temperature of wetted parts section (for high temperature and vacuum 4, 5 m)

[Flange diameter: Flush diaphragm 2 inches (50 mm) / 1.5 inch (40 mm)]

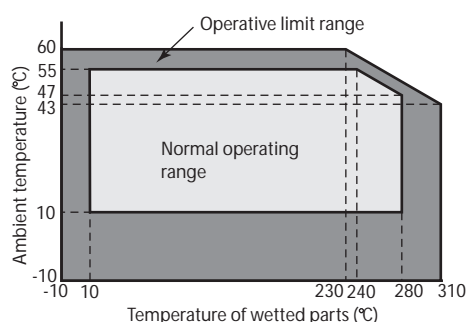

Figure 15 Ambient temperature and temperature of wetted parts section (for high temperature and high vacuum 2, 3 m)

[Flange diameter: Flush diaphragm 2 inches (50 mm) / 1.5 inch (40 mm)]

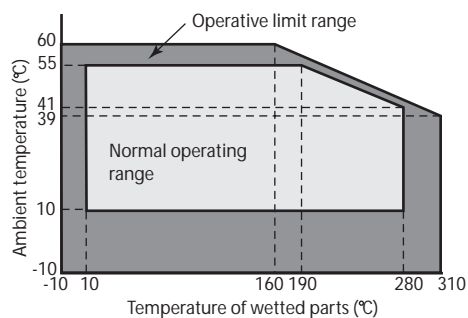

Figure 16 Ambient temperature and temperature of wetted parts section (for high temperature and high vacuum 4, 5 m)

[Flange diameter: Flush diaphragm 2 inches (50 mm) / 1.5 inch (40 mm)]

PHYSICAL SPECIFICATIONS**Materials****Fill fluid**

Silicone oil for general purpose models
Fluorine oil for oxygen and chlorine models

Center body

316 SST

Transmitter case

Aluminum alloy

GTX__D, __G, __A**Meter body cover flange**

SCS14A (Equivalent to 316 SST) or 316 SST, PVC

For Wetted parts**Adapter flange (option)**

SCS14A (Equivalent to 316 SST), PVC

Center body

316 SST (Diaphragm 316L SST)
ASTM B575 (Equivalent to Hastelloy C-276), Tantalum, 316L SST

Vents and plugs

316 SST, PVC

GTX__F**Meter body cover**

SCS14A (equivalent to 316 SST) or 316 SST

For Wetted parts**Adapter flange (option)**

SCS14A (equivalent to 316 SST)

Center body

316 SST (316L SST for diaphragm only)
ASTM B575 (Hastelloy C-276 equivalent), Tantalum, 316L SST

Vents and plugs

316 SST

Gaskets

FEP

Flange materials

304 SST, 316 SST, 316L SST

GTX__R, __U**Meter body cover**

SCS14A (316L SST for diaphragm only)
ASTM B575 (Hastelloy C-276 equivalent), Tantalum, 316L SST

For wetted parts

SCS14A (316L SST for diaphragm only)
ASTM B575 (Hastelloy C-276 equivalent), Tantalum, 316L SST

Flange materials

304 SST, 316 SST, 316L SST

Capillary tube material

316 SST

Armored tube material

304 SST

Coating (optional)

Olefin coating to improve corrosion resistance
(Not applicable for high-temperature / Vacuum service type and High-temperature / High-vacuum service type.)

GTX__S**Transmitter case**

Aluminum alloy

Meter body cover

304 SST

For Wetted parts

316 SST (316L SST for diaphragm only)
316L SST

Flange materials

304 SST, 316 SST, 316L SST

Capillary tube material

316 SST

Armored tube material

304 SST

Weight**GTX30D, 60G, 30A, 60A**

Approx. 3.6 kg

GTX__F

Approx. 5.9 kg (in case of ANSI 150# - 1.1/2 inches flange)

GTX__F

Approx. 20.0 kg
(Including ANSI 150# - 3 inches flange and capillary 5 m long)

GTX__U

Approx. 13.5 kg
(Including ANSI150 # - 3 inches flange and capillary 5 m long.)

GTX__S

Approx. 13.5 kg
(Including ANSI 150# - 3 inches flange and capillary 5 m long)

Document Number: CM2-GTX100-2001

Document Name: AT9000 Advanced Transmitter
Electronic Differential Pressure/Pressure Transmitter
User's Manual

Date: Nov. 2008(rev.3), May 2008(initial)

Issued/Edited by: Yamatake Corporation

Yamatake Corporation